



Infrastructure Master Plan 2024 2024/2025 - 2054/2055

VOLUME 2
uMngeni System



Infrastructure Development Division, uMngeni-uThukela Water

310 Burger Street, Pietermaritzburg, 3201, Republic of South Africa
P.O.Box 9, Pietermaritzburg, 3200, Republic of South Africa
Tel: +27 (33) 341 1111 / Fax: +27 (33) 341 1167 / Toll free: 0800 331 820
Email: info@umngeni.co.za / Web: www.umngeni-uthukela.co.za

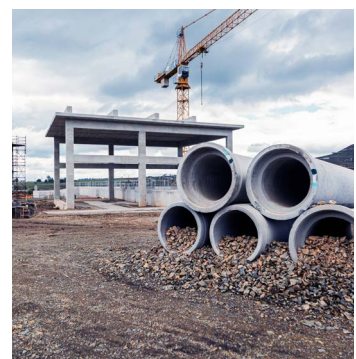

To create value for our customers by providing water services at the right quality and quantity, within acceptable levels of reliability and affordability, to support sustainable economic development in KwaZulu-Natal.



For further information, please contact:

Planning Services
Infrastructure Development Division
Umgeni Water

P.O.Box 9, Pietermaritzburg, 3200
KwaZulu-Natal, South Africa

Tel: 033 341-1522

Fax: 033 341-1218

Email: info@umgeni.co.za

Web: www.umngeni-uthukela.co.za



UMNGENI-UTHUKELA WATER

INFRASTRUCTURE MASTER PLAN 2024

2024/2025 – 2054/2055

JUNE 2024

Prepared by:

Digitally signed by Mark Scott
DN: cn=Mark Scott, o=Umgeni
Water, ou=Planning Services,
email=mark.scott@umgeni.co.z
a, c=ZA
Date: 2024.06.25 11:20:44
+02'00'

Mark Scott PrTechEng

Planning Engineer

PS Sithole
Digitally signed by PS Sithole
DN: cn=PS Sithole, o=uMngeni-uThukela
Water, ou=Planning Services Department,
email=sandile.sithole@umgeni.co.za, c=ZA
Date: 2024.06.25 15:08:06 +02'00'

Sandile Sithole PrSciNat

Hydrologist

Approved by:

**Kevin
Meier**

Digitally signed by
Kevin Meier
Date: 2024.06.25
15:40:26 +02'00'

Kevin Meier PrEng

Manager: Planning Services

Alan Kockott
Digitally signed by Alan Kockott
DN: cn=Alan Kockott, o=uMngeni-
uThukela Water, ou=Engineering Services,
email=alan.kockott@umgeni.co.za, c=ZA
Date: 2024.06.27 08:22:30 +02'00'

Alan Kockott PrEng

Acting Executive: Infrastructure Development

PREFACE

This Infrastructure Master Plan 2024 describes:

- uMngeni-uThukela Water’s infrastructure plans for the financial period 2024/2025 – 2054/2055, and
- Infrastructure master plans for other areas outside of uMngeni-uThukela Water’s Operating Area but within KwaZulu-Natal.

It is a comprehensive technical report that provides information on current infrastructure and on future infrastructure development plans. This report replaces the last comprehensive Infrastructure Master Plan that was compiled in 2023.

The report is divided into **ten** volumes as per the organogram below.

Volume 1 includes the following sections and a description of each is provided below:

- **Section 2** describes the most recent changes and trends within the primary environmental dictates that influence development plans within the province.
- **Section 3** relates only to the uMngeni-uThukela Water Operational Areas and provides a review of historic water sales against past projections, as well as uMngeni-uThukela Water’s most recent water demand projections, compiled at the end of 2023.
- **Section 4** describes Water Demand Management initiatives that are being undertaken by the utility and the status of Water Demand Management Issues in KwaZulu-Natal.
- **Section 5**, which also relates to uMngeni-uThukela Water’s Operational Area, contains a high level review of the energy consumption used to produce the water volumes analysed in **Section 3**.
- **Section 6** provides an overview of the water resource regions and systems supplied within these regions.

The next eight volumes describe the current water resource situation and water supply infrastructure of the various systems in KwaZulu-Natal, including:

- **Volume 2 Section 7** uMngeni System.
- **Volume 3 Section 8** uMkhomazi System
Section 9 uMzimkhulu System
Section 10 Mzintlava System
- **Volume 4 Section 11** South Coast System
- **Volume 5 Section 12** North Coast System
- **Volume 6 Section 13** Upper uThukela System
- **Volume 7 Section 14** Buffalo System
- **Volume 8 Section 15** Middle uThukela System
Section 16 Mhlathuze System
- **Volume 9 Section 17** Umfolozi System
Section 18 uMkhuze / uPhongolo / Lake Sibiyi System

Volume 10, Section 19 describes the wastewater works currently operated by uMngeni-uThukela Water (shown in pale brown in the adjacent figure) and provides plans for development of additional wastewater treatment facilities. The status of wastewater treatment in WSA’s that are not supplied by uMngeni-uThukela Water are also described in this section.

Infrastructure Master Plan 2024/2025

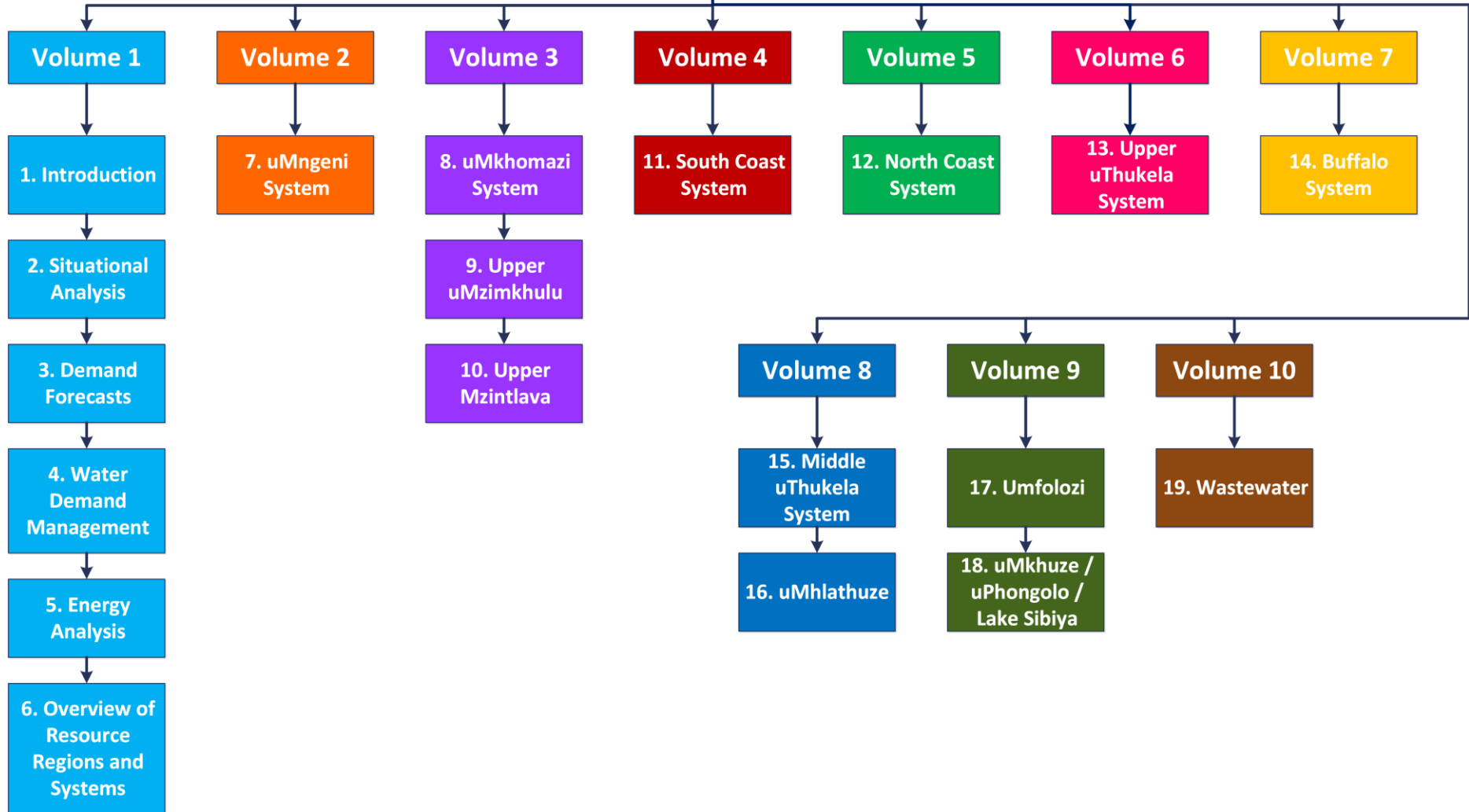

It is important to note that information presented in this report is in a summarised form and it is recommended that the reader refer to relevant planning reports if more detail is sought. Since the primary focus of this Infrastructure Master Plan is on bulk supply networks, the water resource infrastructure development plans are not discussed at length. The Department of Water and Sanitation (DWS), as the responsible authority, has undertaken the regional water resource development investigations. All of these investigations have been conducted in close collaboration with uMngeni-uThukela Water and other major stakeholders in order to ensure that integrated planning occurs. Details on these projects can be obtained directly from DWS, Directorate: Options Analysis (East).

The Infrastructure Master Plan is a dynamic and evolving document. Outputs from current planning studies, and comments received on this document will therefore be taken into account in the preparation of the next update.

TABLE OF CONTENTS

Preface	i
Table of Contents	iv
List of Figures	v
List of Tables	viii
List of Acronyms.....	x
List of Units	xiii
7. uMngeni System	1
7.1 Synopsis of uMngeni System.....	1
7.2 Water Resources of the uMngeni System.....	8
7.2.1 Description of the uMngeni System Water Resource Regions	8
7.2.2 Reserve.....	31
7.2.3 Climate Change Impacts.....	32
7.2.4 Existing Infrastructure and Yields.....	34
7.2.5 Operating Rules.....	43
7.3 Supply Systems	46
7.3.1 Description of the uMngeni System.....	46
7.3.2 Status Quo and Limitations of the uMngeni System	86
7.4 Water Balance/Availability	104
7.5 Recommendations for the uMngeni System.....	106
7.5.1 System Components	106
7.5.2 Projects.....	120
7.6 Management and Operation of uMgungundlovu Water Treatment Plants (WTPs).....	143
7.6.1 Lidgetton WTP.....	145
7.6.2 Mpofana WTP	149
7.6.3 New Spring Grove WTP	154
7.7 uMzinyathi Water Treatment Plants.....	159
7.7.1 Muden WTP and Supply System	159
7.8 Recommendations for the uMzinyathi Water Treatment Plants.....	167
7.8.1 Projects.....	169
References	171
Acknowledgements.....	I

LIST OF FIGURES

Figure 7.1	General layout of the uMngeni System.....	2
Figure 7.2	Network chart of the uMngeni System.....	3
Figure 7.3	General layout of the Upper uMngeni System.....	4
Figure 7.4	Schematic of the Upper uMngeni System.....	5
Figure 7.5	General layout of the Lower uMngeni System.....	6
Figure 7.6	Schematic of the Lower uMngeni System.....	7
Figure 7.7	General layout of the Mooi/uMngeni Region (DEFF 2020; MDB 2020; UMngeni-uThukela Water 2022; WR2012).	10
Figure 7.8	Groundwater potential in the Mooi/uMngeni Region (after DWAF 1997 and WR2012, MDB 2020, UMngeni-uThukela Water 2022).	13
Figure 7.9	Algal response and nutrient loadings for Midmar Dam.....	16
Figure 7.10	Algal response and nutrient loadings for Spring Grove Dam.....	17
Figure 7.11	Algal response and nutrient loadings for Mearns.....	18
Figure 7.12	Algal response and nutrient loadings for Nagle Dam.....	19
Figure 7.13	Algal response and nutrient loadings for Inanda Dam.....	20
Figure 7.14	Total algal count – Midmar Dam Main basin.	21
Figure 7.15	Percentage of Msunduzi catchment river sites with <i>E. coli</i> results > 10000 per 100 ml.22	
Figure 7.16	Phosphorus loads - Darvill WWW effluent.....	23
Figure 7.20	Locality map of the uMkhomazi, uMlaza and uMngeni river catchments.....	26
Figure 7.21	General layout of the Mkhomazi Region (DEFF 2020; MDB 2020; UMngeni-uThukela Water 2022; WR2012).	27
Figure 7.22	Groundwater potential in the Mkhomazi Region (after DWAF 1997 and WR2012, MDB 2020, UMngeni-uThukela Water 2022).	29
Figure 7.23	Algal response for Home Farm Dam.	30
Figure 7.24	Midmar Dam.....	36
Figure 7.25	Albert Falls Dam.	37
Figure 7.26	Nagle Dam.	38
Figure 7.27	Inanda Dam.	39
Figure 7.28	Mearns Weir.....	40
Figure 7.29	Spring Grove Dam.....	41
Figure 7.30	Henley Dam.	42
Figure 7.31	Schematic of the uMngeni System.....	44
Figure 7.32	Midmar Water Treatment Plant after the upgrade.	47
Figure 7.33	General Layout of the Howick-North Sub-System.	51
Figure 7.34	General Layout of the Howick-West Sub-System.....	53
Figure 7.35	General Layout of the Midmar WTP to Umlaas Road Reservoir Sub-System.	58
Figure 7.36	Pipeline configuration between D.V. Harris WTP and World’s View Reservoir.....	61
Figure 7.37	General Layout of the Umlaas Road Reservoir Sub-System.....	65
Figure 7.38	D.V. Harris Water Treatment Plant.	67
Figure 7.39	General layout of the uMshwathi Sub-System.....	71
Figure 7.40	Layout of the Central Supply System.	78
Figure 7.41	Distribution of Demands in Upper uMngeni per WSAs (October 2023).	86
Figure 7.42	Water demand from Midmar WTP.	88
Figure 7.43	Analysis of historical production at Midmar WTP (November 2022 to October 2023).	89
Figure 7.44	Water demand from D. V. Harris WTP.	93
Figure 7.45	Analysis of historical production at D.V. Harris WTP (November 2022 to October 2023).	94

Figure 7.46	Analysis of historical production at Durban Heights WTP from November 2022 to October 2023.....	96
Figure 7.47	Historical demand curve for Durban Heights WTP.	97
Figure 7.48	Extent of the South Coast Augmentation Scheme.	98
Figure 7.49	Analysis of historical production at Wiggins WTP from November 2022 to October 2023.	99
Figure 7.50	Historical demand curve for Wiggins WTP.	100
Figure 7.51	Maphephethwa Water Treatment Plant.	102
Figure 7.52	Analysis of historical production at Maphephethwa WTP from November 2022 to October 2023.	103
Figure 7.53	Historical demand curve and projections for Maphephethwa WTP.	104
Figure 7.54	Proposed water resource infrastructure in the Mkhomazi Region (KZN DoT 2011; MDB 2016; UMngeni-uThukela Water 2017; WR2012).	107
Figure 7.55	Artistic impression of Smithfield Dam.	108
Figure 7.56	Demand on the Upper uMngeni System as at October 2023.	111
Figure 7.57	Five year demand projection for the Upper uMngeni System.	112
Figure 7.58	Ten year demand projection for the Upper uMngeni System.	113
Figure 7.59	Twenty year demand projection for the Upper uMngeni System.	114
Figure 7.60	Thirty year demand projection for the Upper uMngeni System.	115
Figure 7.61	uMkhomazi Water Project.	121
Figure 7.62	Layout of Water Treatment Plant.	122
Figure 7.63	Layout of pipeline.	123
Figure 7.64	General layout of the Impendle Project Areas.	126
Figure 7.65	Greater Mpofana Bulk Water Supply Scheme.	129
Figure 7.66	Schematic of Greater Mpofana BWSS.	130
Figure 7.67	General Layout of Midmar WTP upgrade.	132
Figure 7.69	General layout of the Umbumbulu Pipeline Upgrade.	134
Figure 7.70	General layout of the Vulindlela System.	135
Figure 7.71	Vulindlela Upgrade.	137
Figure 7.72	Table Mountain Upgrade.	139
Figure 7.73	Layout of the proposed hydropower unit at the Mpofana Outfall.	142
Figure 7.74	General layout of the four uMgungundlovu WTPs being operated and managed by UMngeni-uThukela Water.	144
Figure 7.75	Lidgetton WTP sand wash bays with old dosing system (uMgungundlovu District Municipality 2010).	146
Figure 7.76	Schematic of the Lidgetton System (subject to verification).	146
Figure 7.77	1 Ml/day being constructed at the Lidgetton System.	147
Figure 7.78	Analysis of historical production at Lidgetton WTP (November 2022 to October 2023).	147
Figure 7.79	Water demand from Lidgetton WTP.	148
Figure 7.80	Schematic of the Mpofana System (subject to verification).	150
Figure 7.81	Mpofana WTP (uMgungundlovu District Municipality 2010).	151
Figure 7.82	Analysis of historical production at Mpofana WTP (November 2022 to October 2023).	151
Figure 7.83	Water demand from Mpofana WTP.	152
Figure 7.84	Mpofana Package Plant.	153
Figure 7.85	Spring Grove WTP.	155
Figure 7.86	Schematic of the Spring Grove WTP System (subject to verification).	156
Figure 7.87	Analysis of historical production at Spring Grove WTP (November 2022 to October 2023).	157
Figure 7.88	Water demand from Spring Grove WTP.	158

Figure 7.89 Muden WTP supply system.....160
Figure 7.90 Schematic of the Muden Supply System.....161
Figure 7.91 Aerial view of the Muden WTP (Google Earth 2018).163
Figure 7.92 General layout of the Muden WTP upgrade.169

LIST OF TABLES

Table 7.1	Hydrological characteristics of the Mooi/uMngeni Region (UUW, 2019).....	11
Table 7.2	Water quality sampling points within Msunduzi catchment.	22
Table 7.3	Hydrological characteristics of uMkhomazi River catchment (DWS 2015).....	25
Table 7.4	Hydrological characteristics of the uMkhomazi Region (uMngeni-uThukela Water 2002 and DWA 2013).	28
Table 7.5	Summary of environmental (compensation) flow requirements.	31
Table 7.6	uMngeni-uThukela Water 2019 Climate Change Study results and recommendations (2019: 54 – 56).	33
Table 7.7	Characteristics of Midmar Dam (DWS 2003; 2016a).....	36
Table 7.8	Characteristics of Albert Falls Dam (DWS 1993; 2016b).	37
Table 7.9	Characteristics of Nagle Dam (DWS 2004; uMngeni-uThukela Water 2015).....	38
Table 7.10	Characteristics of Inanda Dam (DWS 1990).	39
Table 7.11	Characteristics of Mearns Weir (DWS, 2003).....	40
Table 7.12	Characteristics of Spring Grove Dam (DWS 2013; uMngeni-uThukela Water 2013).	41
Table 7.13	Characteristics of Henley Dam (uMngeni-uThukela Water 2017).	42
Table 7.14	Sub-divisions of the Upper uMngeni System.	46
Table 7.15	Characteristics of the Midmar WTP.	48
Table 7.16	Pipeline details: '251 Pipeline.	49
Table 7.17	Pump station details: Midmar Raw Water Pump Station.	49
Table 7.18	Clearwell details: Midmar WTP.	49
Table 7.19	Reservoir details: Howick-North Reservoir Complex.	52
Table 7.20	Pump details: Howick-North Sub-System.	52
Table 7.21	Pipeline details: Howick-North Sub-System.....	52
Table 7.22	Pump details: Howick-West Sub-System.	54
Table 7.23	Reservoir details: Howick-West Sub-System.....	55
Table 7.24	Pipeline details: Howick-West Sub-System.....	56
Table 7.25	Reservoir details: Midmar WTP to Umlaas Road Reservoir Sub-System.	59
Table 7.26	Tunnel details: Upper uMngeni System.	59
Table 7.27	Pipeline details: Midmar WTP to Umlaas Road Reservoir Sub-System.	60
Table 7.28	Pump details: Thornville/Hopewell Supply.....	63
Table 7.29	Reservoir details: Umlaas Road Reservoir Sub-System.....	66
Table 7.30	Pipeline details: Umlaas Road Reservoir Sub-System.....	66
Table 7.31	Characteristics of D.V. Harris WTP.	68
Table 7.32	Details of the D.V. Harris clearwells.....	69
Table 7.33	Pipeline details: '51 Pipeline.	69
Table 7.34	Pipeline details: Wartburg Sub-System.....	73
Table 7.35	Pump details: Wartburg Sub-System.	74
Table 7.36	Reservoir details: Wartburg Sub-System.	75
Table 7.37	Characteristics of the Durban Heights WTP.....	77
Table 7.38	Tunnel details: Nagle Aqueduct System (Aqueduct 1 and 2).....	79
Table 7.39	Tunnel details: Nagle Aqueduct System (Aqueduct 3 and 4).....	80
Table 7.40	Siphon Pipeline details: Nagle Aqueducts.....	81
Table 7.41	Reservoir details: Durban Heights WTP.	81
Table 7.42	Pump details: Durban Heights WTP.	81
Table 7.43	Characteristics of the Wiggins WTP.	82
Table 7.44	Tunnel details: Inanda-Wiggins Aqueduct System.....	83
Table 7.45	Pipeline details: Inanda-Wiggins Aqueduct.	83
Table 7.46	Reservoir details: Wiggins WTP.....	84
Table 7.47	Pump details: Wiggins WTP.	84

Table 7.48	Characteristics of the Maphephethwa WTP.	85
Table 7.49	Yield Information for uMngeni System.	104
Table 7.50	Proposed water resource infrastructure for the Mkhomazi Region.....	108
Table 7.51	Yields for proposed water resource infrastructure for Mkhomazi Region (DWA 2013).....	109
Table 7.52	Project description: uMkhomazi Water Project.....	123
Table 7.53	Project information: Impendle BWSS.	127
Table 7.54	Project information: Greater Mpofana Bulk Water Supply Scheme.....	131
Table 7.55	Water forecasts for the Greater Mpofana BWSS.....	132
Table 7.57	Project information: Umbumbulu.....	133
Table 7.58	Project information: Vulindlela Upgrade.	136
Table 7.59	Project information: Table Mountain Upgrade.....	140
Table 7.60	Characteristics of the Lidgetton WTP.....	145
Table 7.61	Characteristics of Mpofana WTP.....	149
Table 7.62	Characteristics of the new Spring Grove WTP.	154
Table 7.63	Summary of Muden WTP Supply System existing infrastructure (DWS 2011).	159
Table 7.64	Characteristics of the Muden WTP.	162
Table 7.65	Pump details: Muden Supply System.....	164
Table 7.66	Reservoir details: Muden Supply System.....	165
Table 7.67	Pipeline details: Muden Supply System.	166
Table 7.68	Project information: Muden BWSS.	170

LIST OF ACRONYMS

AADD	Annual Average Daily Demand
AC	Asbestos Cement
ADWF	Average Dry Weather Flow
API	Antecedent Precipitation Index
AVGF	Autonomous Valveless Gravity Filter
BID	Background Information Document
BPT	Break Pressure Tank
BWL	Bottom Water Level
BWSP	Bulk Water Services Provider
BWSS	Bulk Water Supply Scheme
CAPEX	Capital Expenditure
CMA	Catchment Management Agency
CoGTA	Department of Co-operative Governance and Traditional Affairs
CWSS	Community Water Supply and Sanitation project
DAEA	Department of Agriculture and Environmental Affairs
DEA	Department of Environmental Affairs
DEFF	Department of Environment, Forestry and Fisheries
DM	District Municipality
DRDLR	Department of Rural Development and Land Reform
DWA	Department of Water Affairs
DWS	Department of Water and Sanitation
DWAF	Department of Water Affairs and Forestry
EFR	Estuarine Flow Requirements
EIA	Environmental Impact Assessment
EKZN Wildlife	Ezemvelo KZN Wildlife
EMP	Environmental Management Plan
EWS	eThekweni Water Services
EXCO	Executive Committee
FC	Fibre Cement
FL	Floor level
FSL	Full Supply level
GCM	General Circulation Model
GDP	Gross Domestic Product
GDPR	Gross Domestic Product of Region
GVA	Gross Value Added
HDI	Human Development Index
IDP	Integrated Development Plan
IFR	In-stream Flow Requirements
IMP	Infrastructure Master Plan
IRP	Integrated Resource Plan

ISP	Internal Strategic Perspective
IWRM	Integrated Water Resources Management
KZN	KwaZulu-Natal
LM	Local Municipality
LUMS	Land Use Management System
MA	Moving Average
MAP	Mean Annual Precipitation
MAR	Mean Annual Runoff
MBR	Membrane Bioreactor
MMTS	Mooi-uMngeni Transfer Scheme
MMTS-1	Mooi-uMngeni Transfer Scheme Phase 1
MMTS-2	Mooi-uMngeni Transfer Scheme Phase 2
mPVC	Modified Polyvinyl Chloride
MTEF	Medium-Term Expenditure Framework
MTSF	Medium-Term Strategic Framework
MWP	Mkomazi Water Project
MWP-1	Mkomazi Water Project Phase 1
NCP-1	North Coast Pipeline I
NCP-2	North Coast Pipeline II
NCSS	North Coast Supply System
NGS	Natal Group Sandstone
NPV	Net Present Value
NRW	Non-Revenue Water
NSDP	National Spatial Development Perspective
NWSP	National Water Sector Plan
OPEX	Operating Expenditure
p.a.	Per annum
PES	Present Ecological Status
PEST	Political, Economical, Sociological and Technological
PGDS	Provincial Growth and Development Strategy
PPDC	Provincial Planning and Development Commission (KZN's)
PSEDS	Provincial Spatial Economic Development Strategy
PWSP	Provincial Water Sector Plan
RDP	Reconstruction and Development Programme
RO	Reverse Osmosis
ROD	Record of Decision
RQO	Resource Quality Objective
SCA	South Coast Augmentation
SCP	South Coast Pipeline
SCP-1	South Coast Pipeline Phase 1
SCP-2a	South Coast Pipeline Phase 2a
SCP-2b	South Coast Pipeline Phase 2b

SDF	Spatial Development Framework
SHR	St Helen’s Rock (near Port Shepstone)
STEEPLE	Social/demographic, Technological, Economic, Environmental (Natural), Political, Legal and Ethical
SWRO	Seawater Reverse Osmosis
TEC	Target Ecological Category
TWL	Top Water Level
uPVC	Unplasticised Polyvinyl Chloride
UUW	uMngeni-uThukela Water
WA	Western Aqueduct
WC	Water Conservation
WDM	Water Demand Management
WMA	Water Management Area
WRC	Water Research Commission
WSA	Water Services Authority
WSDP	Water Services Development Plan
WSNIS	Water Services National Information System
WSP	Water Services Provider
WTP	Water Treatment Plant
WWW	Wastewater Works

Spellings of toponyms have been obtained from the Department of Arts and Culture (DAC). DAC provides the official spelling of place names and the spellings, together with the relevant gazette numbers, can be accessed at <http://www.dac.gov.za/content/toponymic-guidelines-map-and-other-editors>.

When using any part of this report as a reference, please cite as follows:

uMngeni-uThukela Water, 2024. uMngeni-uThukela Water Infrastructure Master Plan 2024/2025 – 2054/55, Vol 1 - 10. Prepared by Planning Services, June 2024.

LIST OF UNITS

Length/Distance:	mm	millimetre
	m	metre
	km	kilometre
Area:	m ²	square metres
	ha	hectare
	km ²	square kilometres
Level/Altitude:	mASL	metres above sea-level
Time:	s	second
	min	minute
	hr	hour
Volume:	m ³	cubic metres
	Mℓ	megalitre
	million m ³	million cubic metres
	mcm	million cubic metres
Water Use/Consumption/Treatment/Yield:	ℓ/c/day	litre per capita per day
	kℓ/day	kilolitre per day
	Mℓ/day	megalitre per day
	million m ³ /annum	million cubic metres per annum
	kg/hr	kilograms per hour
Flow velocity/speed:	m/s	metres per second
Flow:	m ³ /s	cubic metres per second
	ℓ/hr	litres per hour
	m ³ /hr	cubic metres per hour

7. UMNGENI SYSTEM

7.1 Synopsis of uMngeni System

The Durban-Pietermaritzburg Region's (the primary economic hub of KZN) main source of potable water is the uMngeni System (**Figure 7.1**). Comprising of five storage dams and a weir in the Mooi/uMngeni Water Resource Region, four of which are located on the uMngeni River (**Figure 7.1**), it is an integrated water resource and bulk potable water distribution system made up of two major sub-systems, viz.

- The Upper uMngeni System (also referred to as the Inland System; **Figure 7.2**) serving the uMgungundlovu District Municipality, Msunduzi Municipality and eThekweni Municipality's Outer West area, and
- The Lower uMngeni System (**Figure 7.2**) serving the coastal areas and hinterland of the eThekweni Municipality. This sub-system also serves the northern coastal areas of Ugu District Municipality via the South Coast Augmentation Pipeline and the South Coast Pipeline (**Section 7.3.1 (i)**).

The uMngeni System is shown in **Figure 7.1** and **Figure 7.2**. The water resources of the two sub-systems are located on the same river system and are highly inter-dependant (**Section 7.2**). The respective bulk distribution systems are inter-connected by uMngeni-uThukela Water's infrastructure and eThekweni Metropolitan Municipality's Western Aqueduct.

Figure 7.3 and **Figure 7.5** show the Upper uMngeni System and **Figure 7.7** and **Figure 7.6**, the Lower uMngeni System.

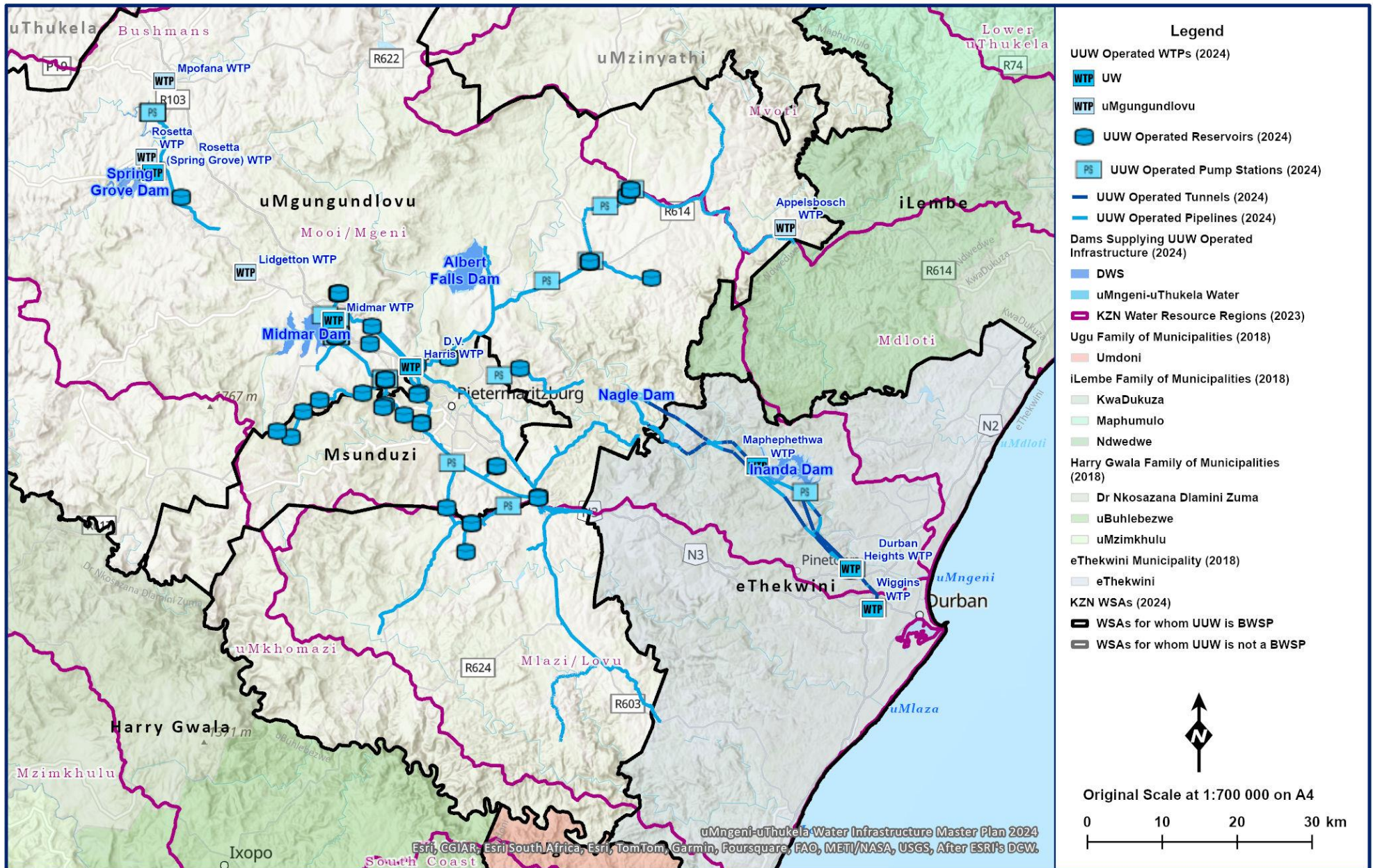

Figure 7.1 General layout of the uMngeni System

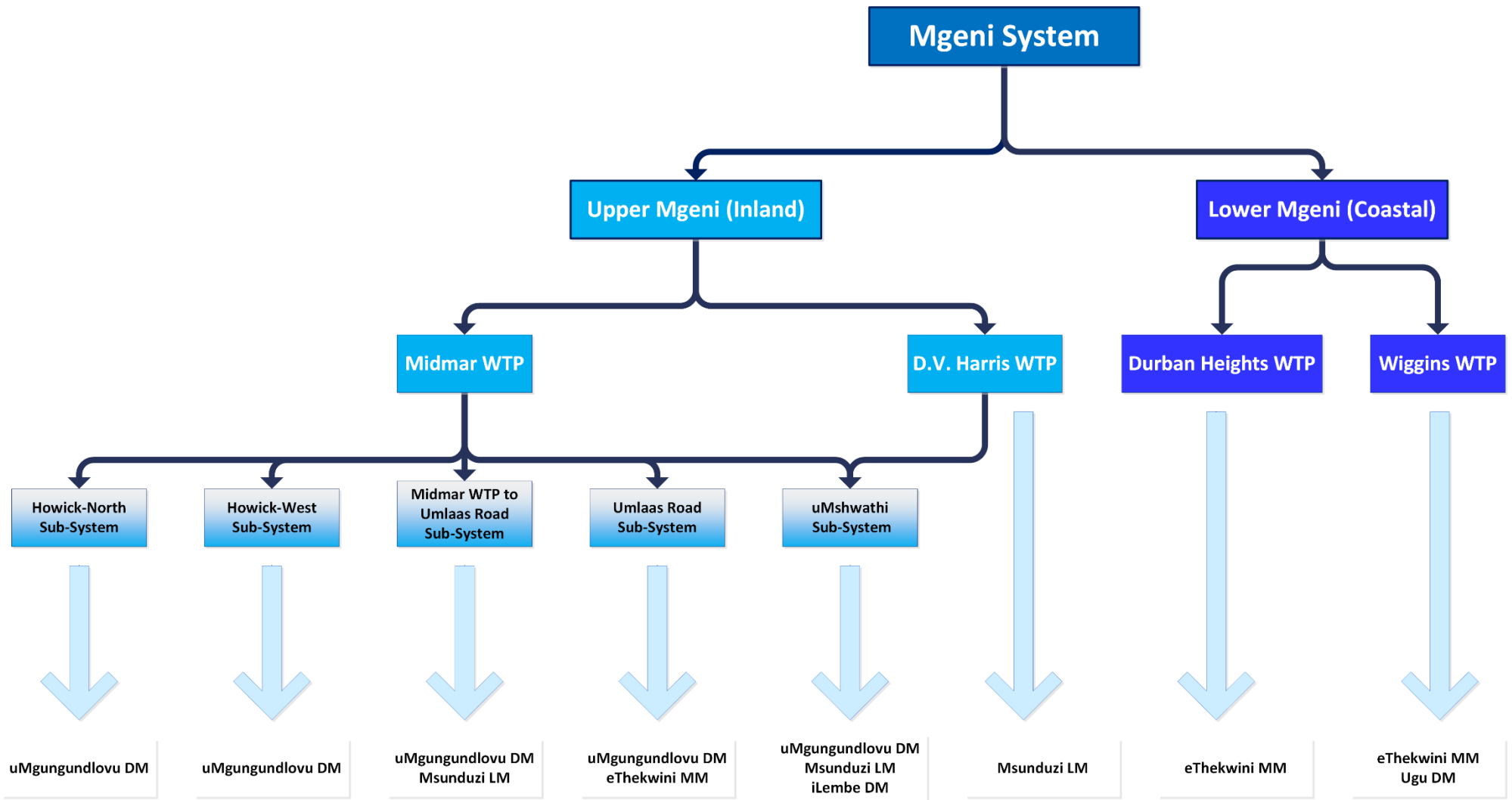

Figure 7.2 Network chart of the uMngeni System.

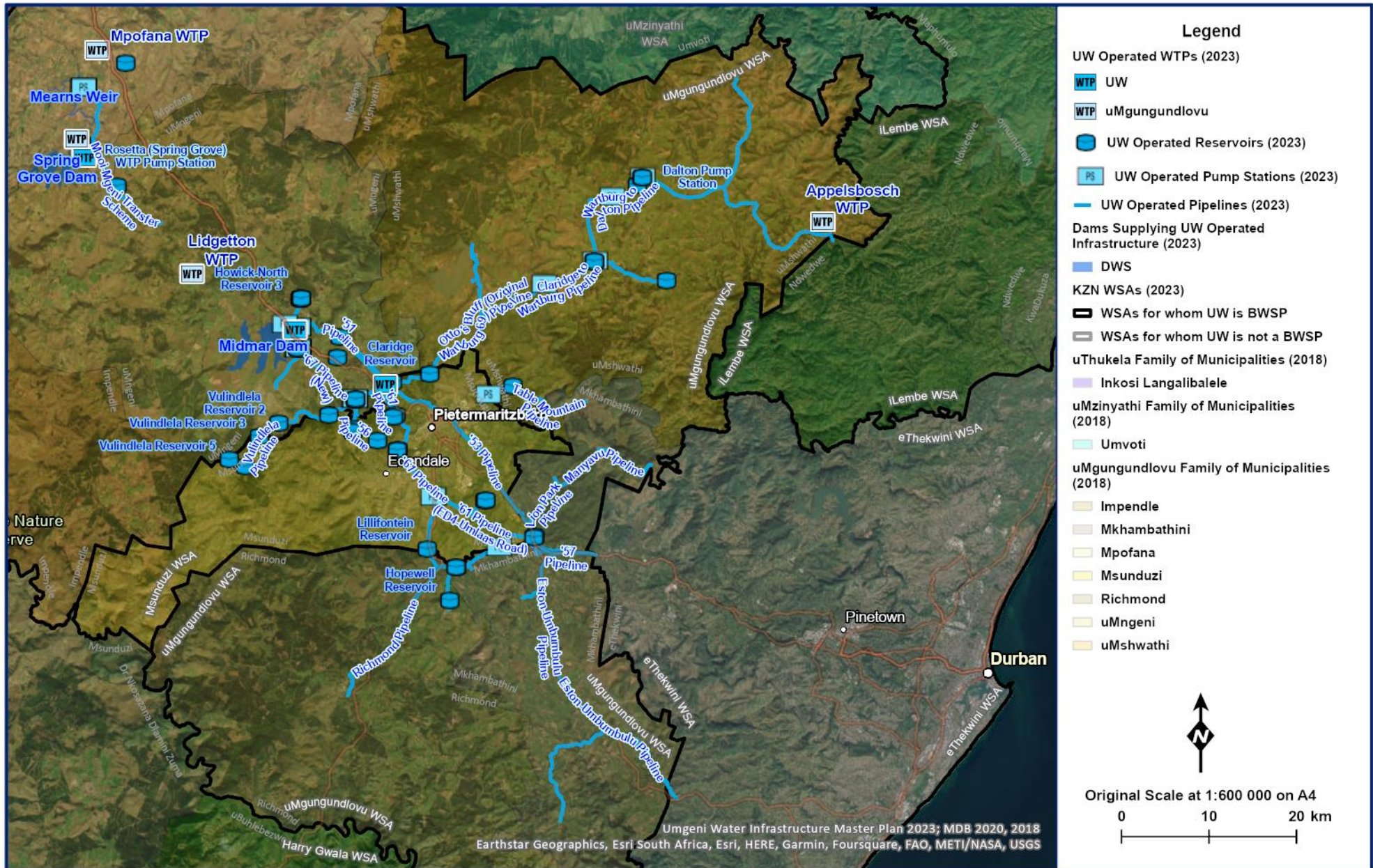

Figure 7.3 General layout of the Upper uMngeni System.

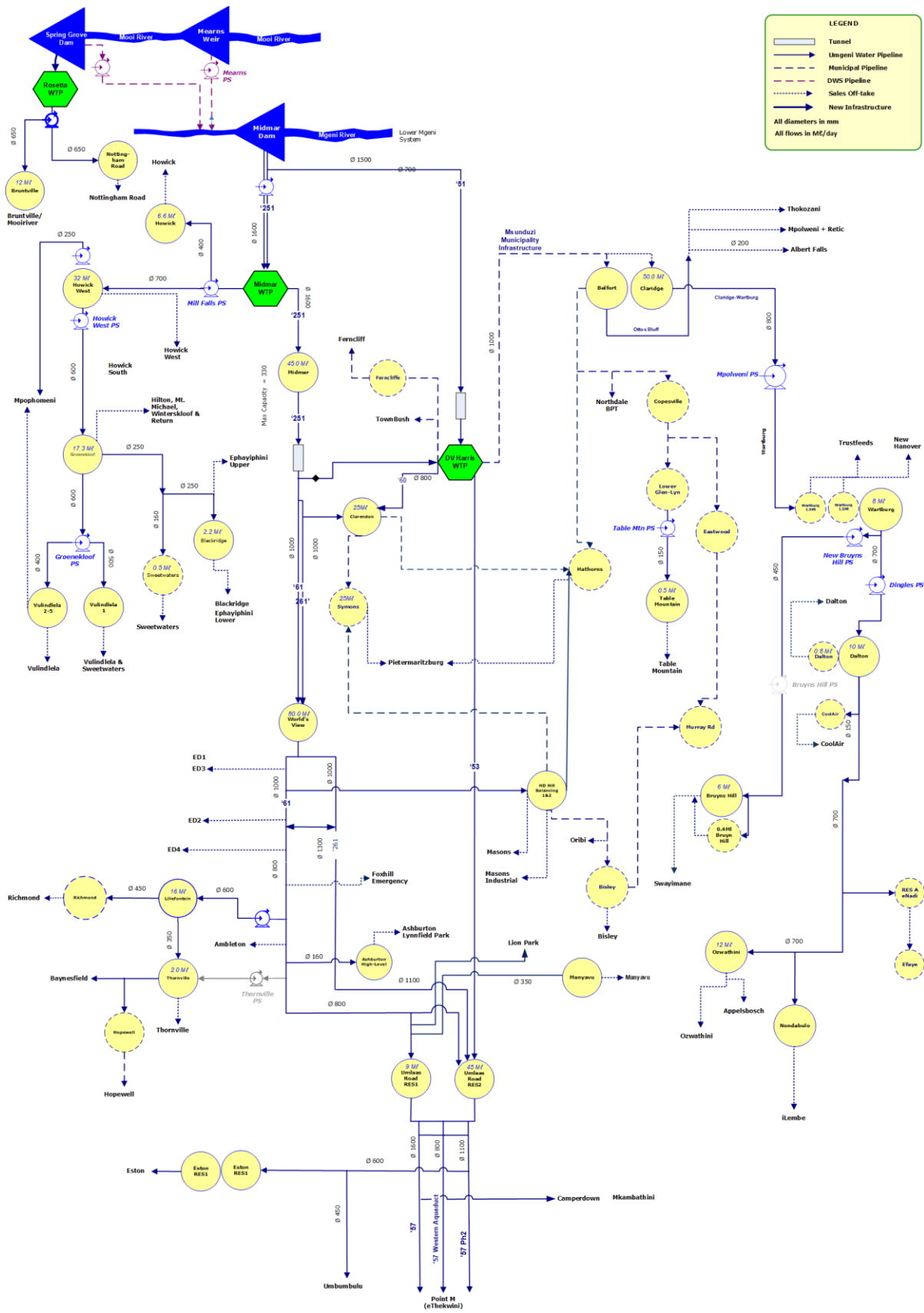

Figure 7.4 Schematic of the Upper uMngeni System.

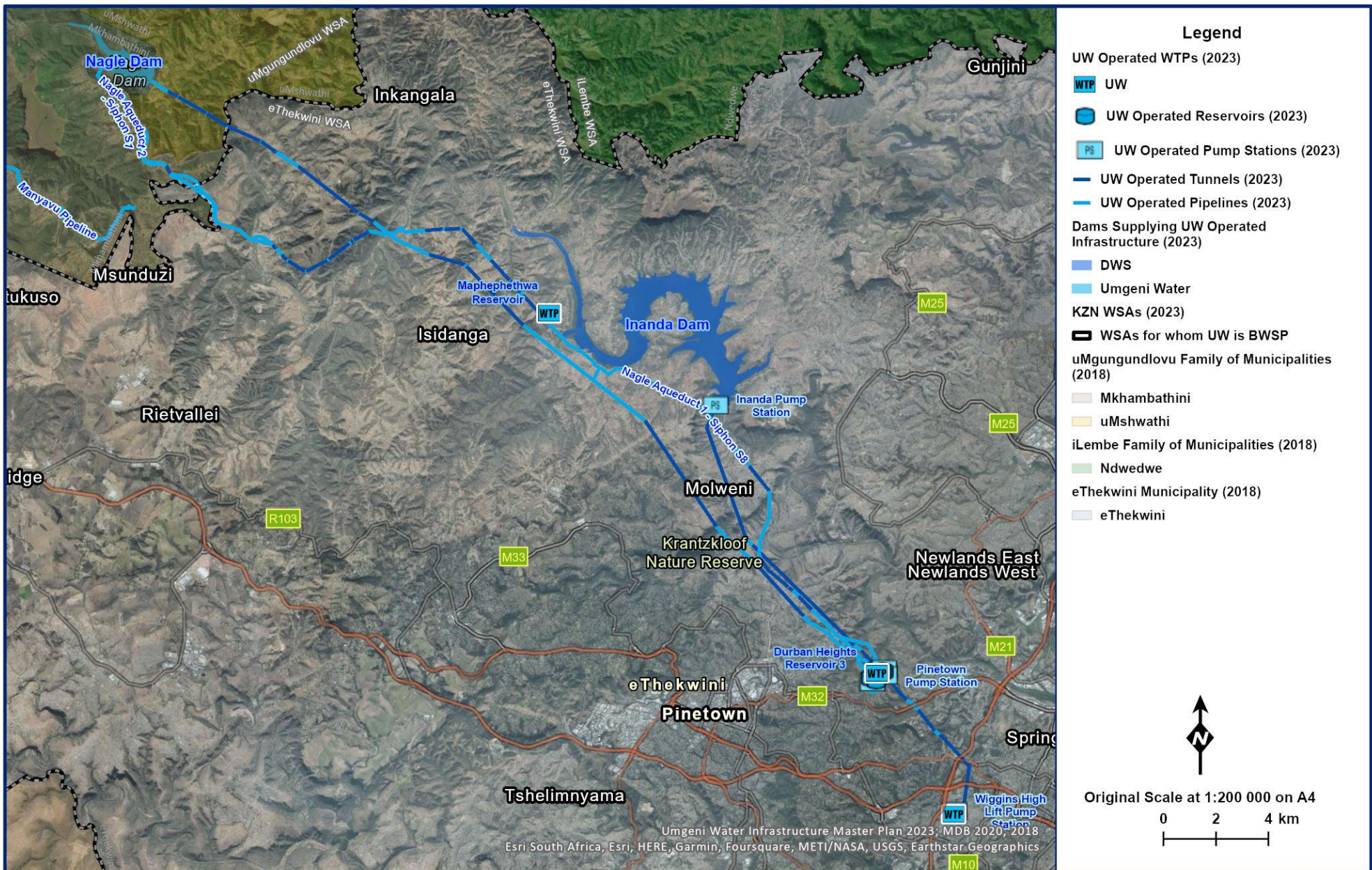

Figure 7.5 General layout of the Lower uMngeni System.

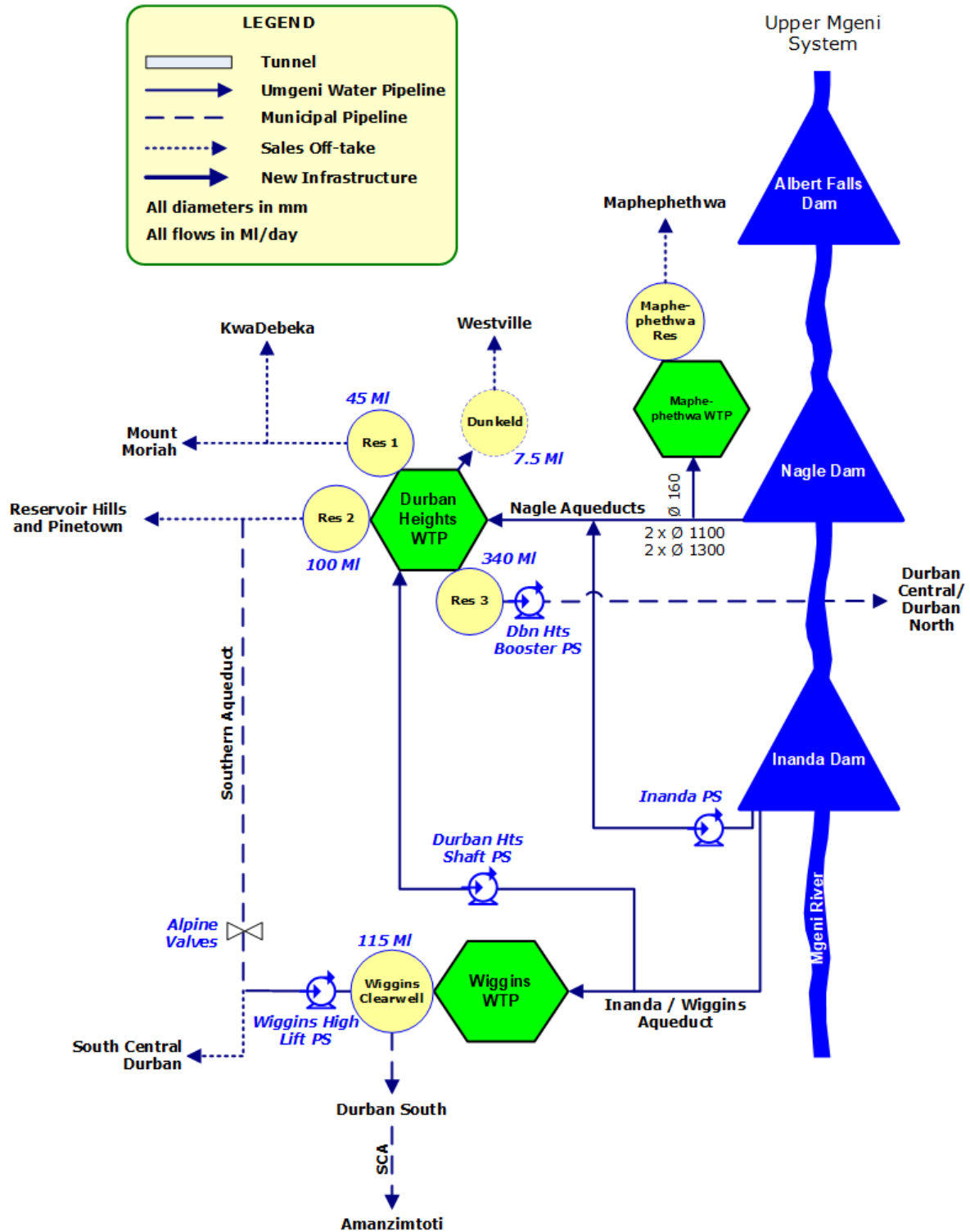

Figure 7.6 Schematic of the Lower uMgeni System.

7.2 Water Resources of the uMngeni System

7.2.1 Description of the uMngeni System Water Resource Regions

(a) Mooi/uMngeni Water Resource Region

(i) Overview

The Mooi/uMngeni region comprises of the two tertiary catchments of U20 (uMngeni River) and V20 (Mooi River). Water is stored in the Mooi River Catchment and transferred to the uMngeni System to augment supply. While the focus on the Mooi River is on the upper reaches and the associated water transfer to the uMngeni, downstream parts of the Mooi River catchment are also of interest to uMngeni-uThukela Water as they influence releases of water from the Mearns Weir, which in turn impacts on water available for transfer to the uMngeni System.

The major urban centres of Durban and Pietermaritzburg are situated within the uMngeni catchment. There are a number of other urban and peri-urban centres within this region including Mooi River, Rosetta, Nottingham Road, Howick, Wartburg, Cato Ridge, and the greater surrounds of both Durban and Pietermaritzburg. The urban centres from Howick towards the coast receive their water from the uMngeni system.

The uMngeni River has been fully developed with the construction of four major dams, viz. Nagle (1950), Midmar (1965), Albert Falls (1976) and Inanda (1988). Both the Mooi and uMngeni catchments are no longer open to stream flow reduction activities such as afforestation, expansion of irrigated agriculture or the construction of storage dams, i.e. they are 'closed' catchments. The predominant land use in the Mooi catchment is commercial agriculture, and there is large-scale irrigation of pastures and summer cash crops, with an estimated water requirement of 51 million m³/annum (Mooi-uMngeni Hydrology Update Study, 2019). The other large water use is transfers out to the uMngeni catchment.

In 1983, during a period of severe drought, the Mearns Emergency Transfer Scheme was constructed by DWS to enable water to be transferred from the Mooi River into the uMngeni catchment. The scheme consisted of a 3 m high weir and a pump station at Mearns on the Mooi River, a 13.3 km long, 1 400 mm diameter steel rising main to a break pressure tank situated at Nottingham Road and a 8.3 km long 900 mm diameter steel gravity main to an outfall structure on the Mpofana River. The emergency scheme was operated for a short period until the drought broke and was then mothballed until 1993 when uMngeni-uThukela Water re-commissioned it for a short period again during a drought cycle. Since then the Mearns Emergency Transfer Scheme was operated as and when required until the commissioning of the Mooi-uMngeni Transfer Scheme Phase 1 (MMTS-1) in 2003.

The MMTS-1 ensured that a maximum flow of 3.2 m³/s could be transferred from the Mooi River into the uMngeni catchment on a more sustained basis than was possible before. Raw water is pumped from a larger Mearns Weir on the Mooi River via the transfer pipeline to an outfall on the Mpofana River. From the Mpofana River the water flows into the Lions River and then into the uMngeni River upstream of Midmar Dam. Phase 2 of the Mooi-uMngeni Transfer Scheme (MMTS-2), which incorporates Spring Grove Dam on the Mooi River and a transfer scheme to pump 4.5 m³/s was completed in 2016. The MMTS-2 has the flexibility of pumping 4.5 m³/s on a continuous basis from Spring Grove Dam or 3.2 m³/s from the Mearns Weir. Operation of this scheme depends on the levels in each of these water resources as well as the need for water at Midmar and Albert Falls dams.

The construction of Spring Grove Dam brought the uMngeni System back into balance, albeit for a short period. As the water demands and system losses continued to increase with growth and urbanisation, the system fell into a deficit again. This deficit could extend for some time if the management of water resources and water losses, during the current deficit period, are not carefully practiced. Approximately, 260 Mℓ/day of water has been supplied during the year 2023 over and above the system yield of just under 1100 Mℓ/day at a 1 in 100 year assurance level. Approximately, 70 Mℓ/day of water has been supplied during the year 2023 over and above the water use licence for the system which is at a 1 in 20-year assurance level.

The water demand management data has shown that, of the total water purchases, approximately less than 50% is deemed revenue water in this system. The system losses in the distribution network have escalated to concerning levels in the recent times leading to the current situation. DWS issued a Notice of Intent to issue a Directive in July 2023 to UUW to comply with the abstraction licence and as a result UUW is taking steps, together with WSA's, to reduce abstraction volumes from the uMngeni System by reducing demand at the customer level. Water service authorities have to address water demand management, failing which water supply will have to be reduced at the UUW water treatment plants. Some of the water service authorities have made some progress on the water loss reduction initiatives and some have not.

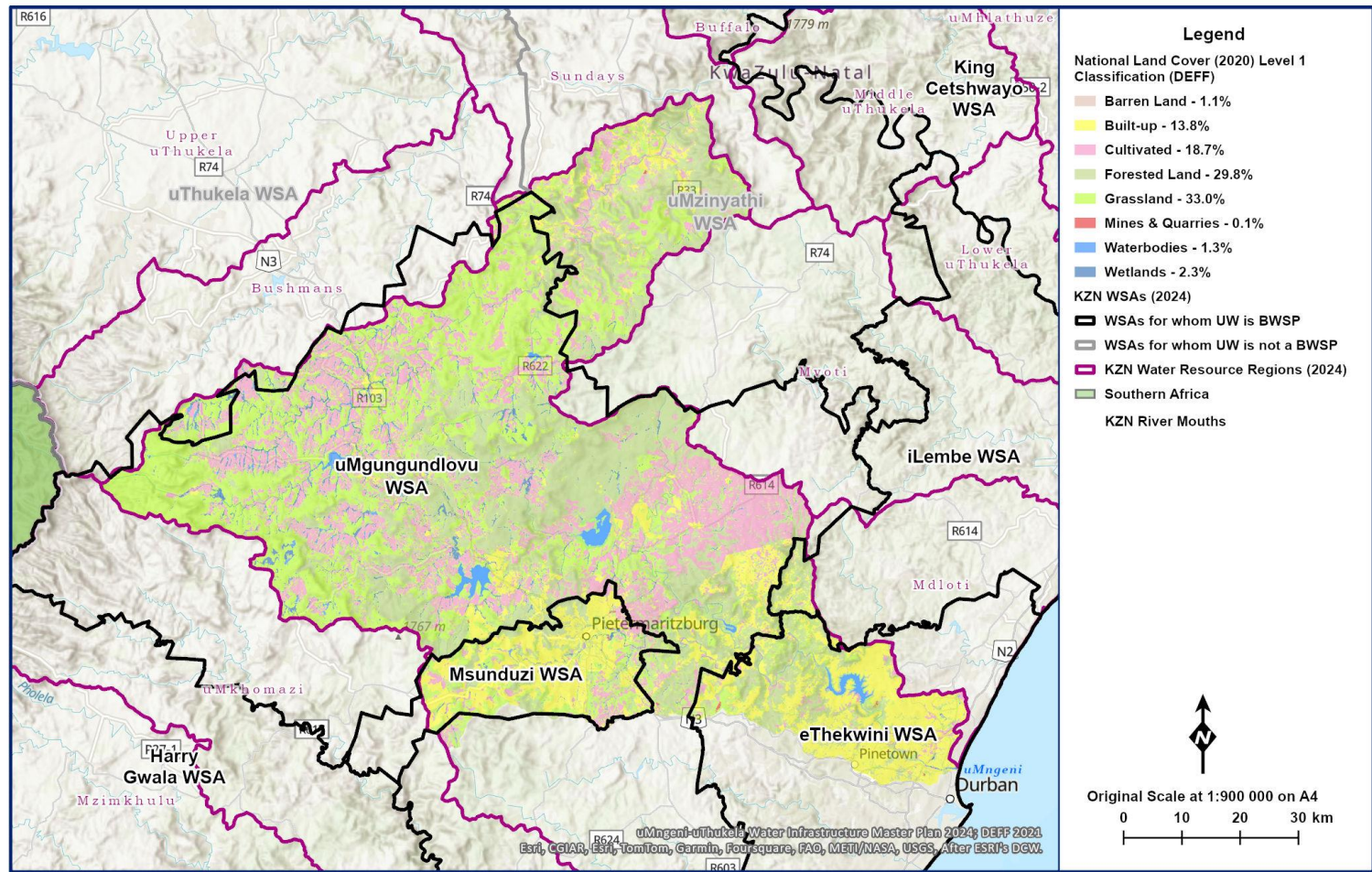

Figure 7.7 General layout of the Mooi/uMngeni Region (DEFF 2020; MDB 2020; UMngeni-uThukela Water 2022; WR2012).

(ii) Surface Water

The hydrological statistics of the catchments in the Mooi-uMngeni Region are summarised in **Table 7.1**.

Table 7.1 Hydrological characteristics of the Mooi/uMngeni Region (UUW, 2019).

Region	River (Catchment)	Area (km ²)	Annual Average			
			Evaporation (mm)	Rainfall (mm)	Natural Runoff (million m ³ /annum)	Natural Runoff (mm)
Mooi/uMngeni	Mooi River (V20) up to Mearns	1,637	1,342	800	306.1	187
	uMngeni River (U20)	4,439	1,214	932	685.8	155

(iii) Groundwater

The Mooi/uMngeni Region occurs in the KwaZulu-Natal Coastal Foreland and North-western Middleveld Groundwater Regions (Section 2). This Groundwater Region is characterised by intergranular and fracture rock aquifers with extremely low to medium development potential. The underlying geology is mostly arenaceous rocks of the Ecca Formation.

• Hydrogeological Units

The hydrogeologically relevant lithologies recognised in the Mooi/uMngeni region comprise sandstone, tillite and mudstone/shale supporting fractured groundwater regimes and dolerite intrusions and granite/gneiss supporting fractured and weathered groundwater regimes.

• Geohydrology

The overall median yield (0.33 ℓ/s) of boreholes tapping the Natal Group Sandstone (NGS) identifies this lithology as one of the more productive hydrogeological units in the uMngeni catchment. The highest percentage of boreholes (8%) yielding greater than 4.5 ℓ/s can be found in this lithology.

The mudstone/shale of the Ecca Group occurs almost entirely inland at the head of uMngeni River and is the dominant lithology around Pietermaritzburg and Howick. Boreholes tapping these lithologies have median yields of 0.4 ℓ/s.

The tillite of the Dwyka Formation in the uMngeni catchment supports an overall median yield of 0.14 ℓ/s and a relatively high percentage (40%) of dry boreholes.

The granite/gneisses of the Natal Metamorphic Province (NMP) flank uMngeni River and are concentrated around Nagle and Inanda dams. This lithological unit supports a median yield of 0.18 ℓ/s.

An analysis of baseflow-derived stream run-off values per quaternary catchment in the uMngeni catchment suggests that groundwater recharge from rainfall varies in the range 3% to 7% of the mean annual precipitation.

In the Mooi catchment, natural groundwater discharge occurs in the form of springs, seeps and in isolated cases, uncapped artesian boreholes. The wetlands and dams in the headwaters of the Mooi River are supported by perennial groundwater seeps associated with the dolerite sill intrusions in the mudstone/shale lithologies. Springs rising in the sandstone and granite/gneiss lithologies relate to structural features (faults and fracture zones, lineaments). An analysis of baseflow-derived stream run-off values per quaternary catchment suggests that groundwater recharge from rainfall varies in the range 3% to 7% of the mean annual precipitation, similar to that found in the uMngeni catchment.

- **Groundwater Potential**

The greatest widespread demand on the groundwater resources in the Mooi-uMngeni Region is represented by its use as a source of potable water for communities in the rural areas and, to a lesser extent, households in the farming areas. Other demands of a more concentrated nature are represented by its use to supplement rainfall and traditional surface water supplies for irrigation.

The sandstone of the Natal Group represents the most productive groundwater-bearing lithology, followed by mudstone/shale lithologies, the granite/gneiss lithologies and the tillite sediments of the Dwyka Tillite Formation.

A good to fair correlation exists between boreholes supporting yields in the moderate (greater than 0.5 ℓ/s to less than 3.0 ℓ/s) and high (greater than 3.0 ℓ/s) classification ranges and structural features represented by faults and remotely sensed lineaments (**Figure 7.8**).

(iv) Water Quality

- Surface Water

The algal response and nutrient loadings for Midmar Dam are shown in **Figure 7.9**. A greater rainfall amount and inflow volume was recorded in 2022. This resulted in an increase in the amount of nutrients mobilized by runoff. A peak in nutrients and suspended solids (25922 tonnes/annum) loadings was recorded at Midmar Dam inflow. The high suspended solids loads recorded in 2022 resulted in elevated turbidity results in Midmar Dam. A decline has been recorded in 2023 congruent with the lower inflow volumes. Median annual total phosphorus concentrations ranged from 15-26 ug/l which is below the threshold concentration of 55 ug/l reported by Roussouw et. al. (2008), which results in an increased frequency and duration of potentially problematic algal growth. A decline in the *Fragilaria* numbers recorded was observed in 2023. *Fragilaria* is a filter clogging algae that has presents major treated challenges at elevated counts.

The absence of flow measuring on Mthunzima river negates nutrient and suspended solids loads quantification. Sewage pollution is an on-going challenge impacting Mthunzima river. The presence of a wetland is playing a critical role in improving the water quality state of this input to Midmar Dam. The assimilative capacity of Midmar Dam has also played a major role in limiting the related water quality challenges. However, the cumulative impact of this sustained sewage pollution has contributed in the water quality challenges and aquatic weed growth recorded at Midmar dam. Midmar Dam is plagued by *Egeria densa* growth challenges that is predominantly on the Mthunzima River inflow side of the impoundment. Numerous interventions, headlined by biocontrol release, have been implemented to manage the growth of *Egeria densa*. However, addressing the sewage contamination challenges will play a key role in suppressing infestation at the dam. Commissioning of the new Mpophomeni WWTW is anticipated to improve Mpophomeni area sewage management.

The algal response and nutrient loadings for Spring Grove Dam are shown in **Figure 7.10**. An increase is reflected by the nutrients (phosphorus and total inorganic nitrogen) loadings and suspended solids loadings recorded in the last two years with particulate phosphorus peaking in 2021 while total inorganic carbon and suspended solids showing an ultimate peak in 2022, this is associated with the increase in inflow volumes. An increasing trend in algal responses is observed at Spring Grove dam from 2018 - 2022, with a decrease in 2023. The decrease is associated with dilution factor emanating from higher flows.

The algal response and nutrient loadings for Mearns Weir are shown in **Figure 7.11**. An increase is reflected by the nutrient (phosphorus and total inorganic nitrogen) loadings and suspended solids loadings recorded in the last two years, particularly at the Little Mooi River inflow to Mearns Dam. The recorded peak is associated with catchment inputs from intensive farming (including numerous piggeries and dairies). The Little Mooi catchment area is heavily utilised for both extensive and intensive commercial agriculture.

The algal response and nutrient loadings for Nagle Dam are shown in **Figure 7.12**. An increase in nutrient loads and extreme increases in suspended solids within the impoundment were recorded during the assessment period (81.63 – 369.7 tonnes TIN/annum and 984 – 17010 tonnes SS/annum between 2018 and 2023), associated primarily with the increased flows into the dam. The significant increase in suspended solids loads was recorded in 2022 and 2023 at the Nagle Dam inflow and is associated with contributions from increased illegal sand-mining activities in combination with major rainfall events in the catchment.

A decreasing trend in algal responses is observed at Nagle Dam, with a minor increase in 2023, with this decrease associated with a well-flushed system emanating from higher flows. Due to recent

extreme catchment events and floods, and with the increased water availability over the past two years, Nagle Dam has been spilled for a greater duration of time (not dropping below 80%). In addition, effective bypassing around the dam has been implemented, which limited the algal response in Nagle Dam, and resulting in decreased algal treatability challenges and no significant geosmin production or requirement for dosing activated carbon at Durban Heights. However, the additional inflow volumes has resulted in ongoing increased nutrient loadings, and are anticipated to be associated with predicted future increases in eutrophication and algal responses, and anticipated further deteriorating raw water quality when water levels decrease.

The algal response and nutrient loadings for Inanda Dam are shown in **Figure 7.13**. An increasing trend and high nutrient loadings coming into the dam was noted with a decrease during 2023. High suspended solids (5185 – 158917 tonnes SS/annum) were recorded between 2018 and 2023, associated with high inflow volumes and catchment run-off. Total phosphorus loads ranged from 45.7 – 224 tonnes/ annum during the past five years, with a peak in 2021. Contributing factors to these increases include the Msunduzi catchment inputs and sewer issues within the Msunduzi Municipality. In addition, agricultural activities in the greater uMngeni catchment contribute to the increase of total inorganic nitrogen (combination of ammonia, nitrate and nitrite), which end-up washing into the river and eventually ending up into Inanda Dam.

Algal counts and trophic status generally correlate with nutrient loading concentrations. Aligned to the trend in nutrient loading, the algal response in Inanda Dam has decreased over the past two years. However, ongoing high nutrient loads entering Inanda Dam, while currently mitigated with a well-flushed uMngeni system, are associated with predicted potential future increases in eutrophication and algal responses, and anticipated further deteriorating raw water quality when water levels decrease.

The potential for algal and plant productivity in Inanda Dam, was classified by the National Eutrophication Monitoring Programme (using the mean annual total phosphorus concentration) as varying between moderate (mid dam and main basin) and serious (upper dam), while the trophic status in the dam varies between hypertrophic (upper dam) and mesotrophic in mid dam and main basin. The current nuisance value of algal productivity increased to significant in the main basin in 2023 due to the storm flows washing the algae towards this area.

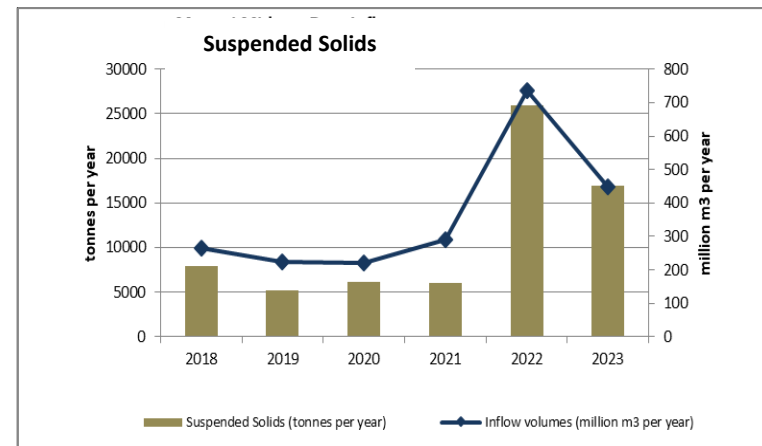
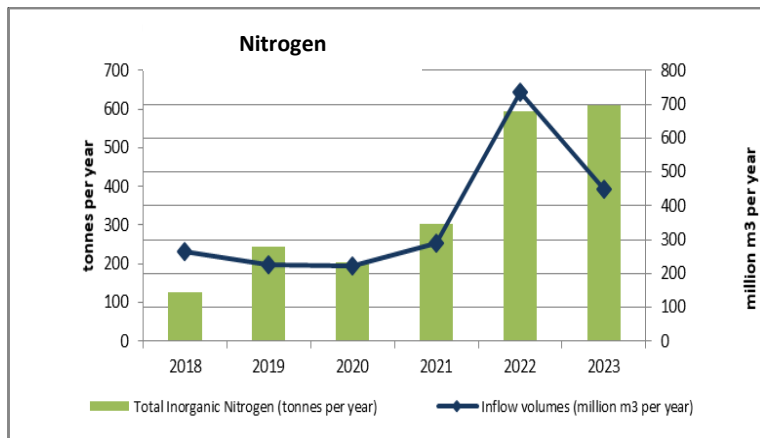
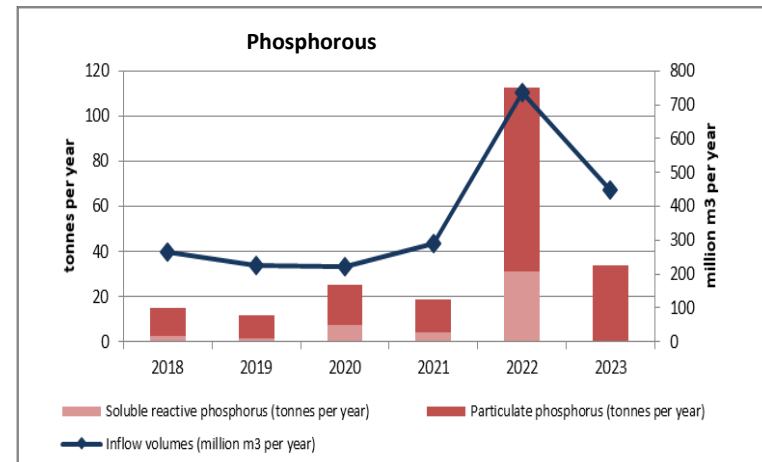
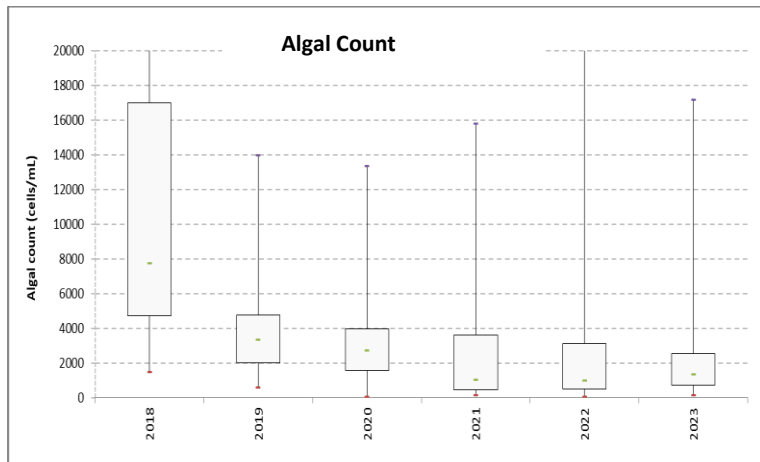

Figure 7.9 Algal response and nutrient loadings for Midmar Dam.

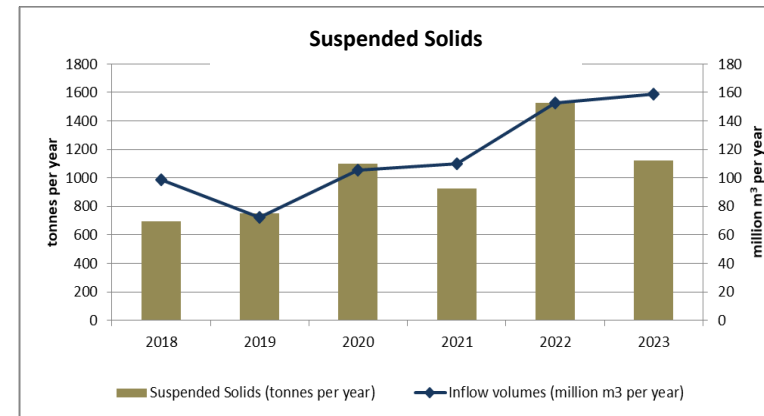
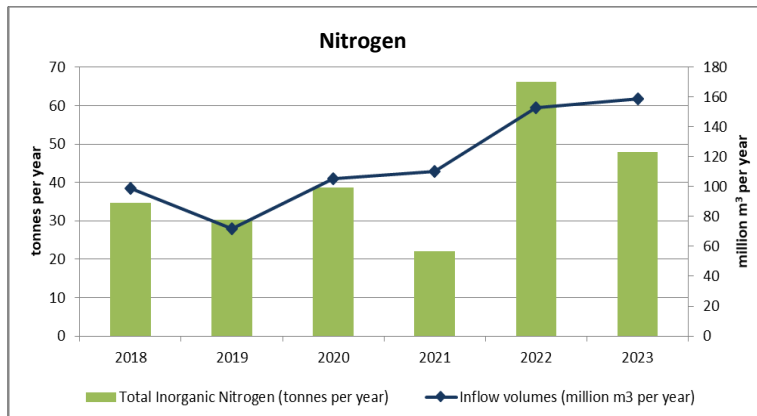
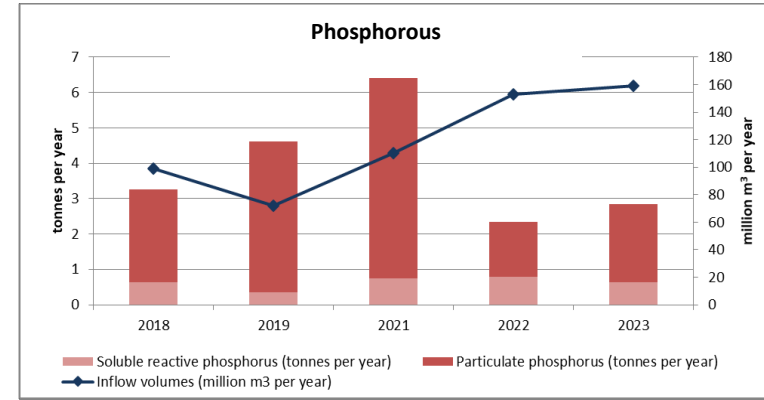
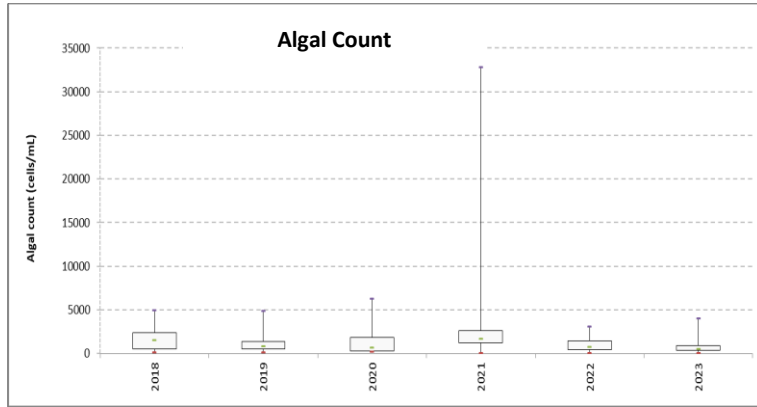

Figure 7.10 Algal response and nutrient loadings for Spring Grove Dam.

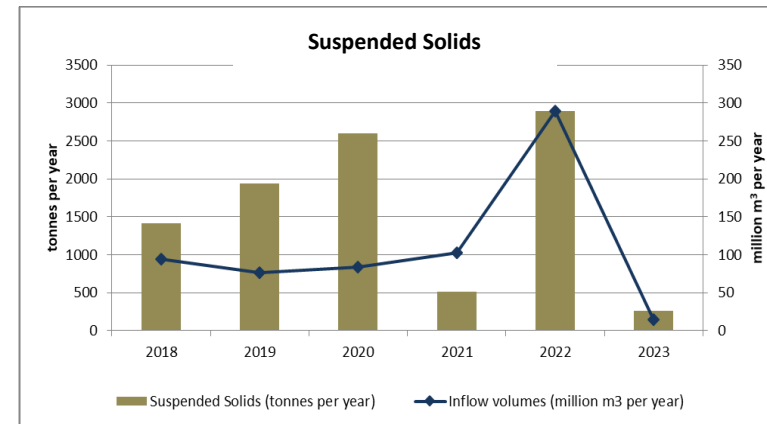
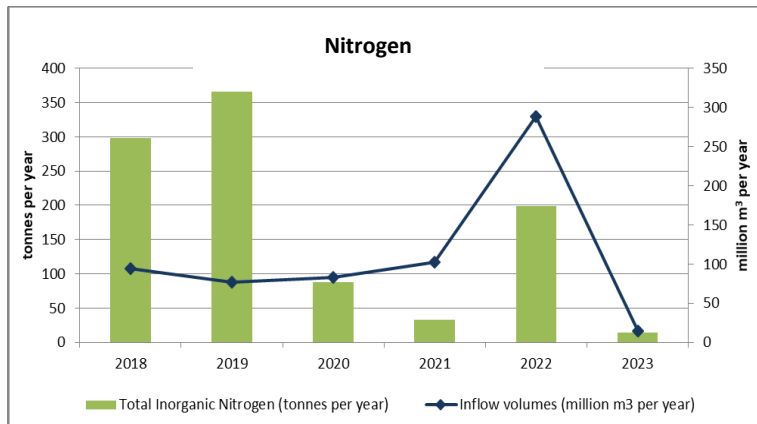
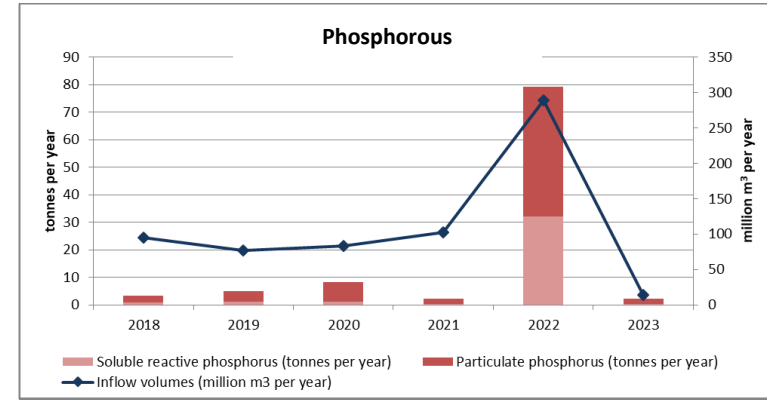
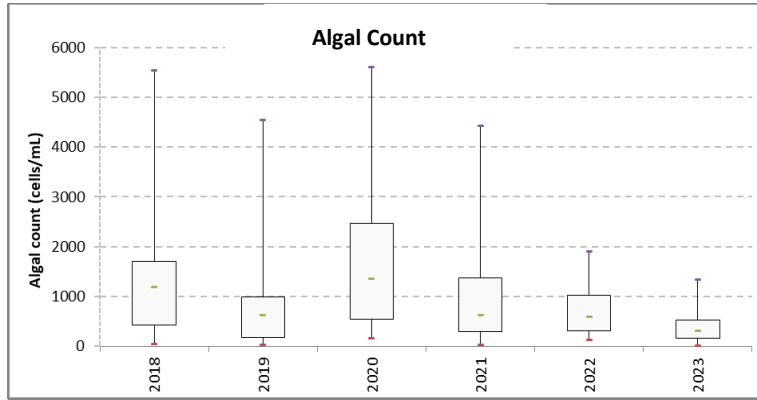

Figure 7.11 Algal response and nutrient loadings for Mearns.

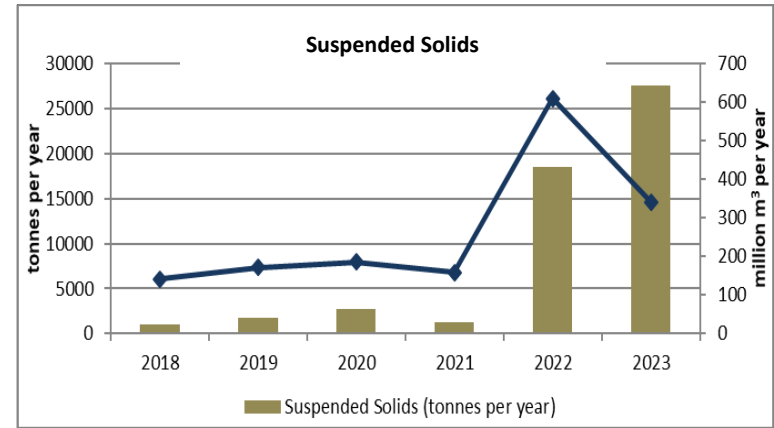
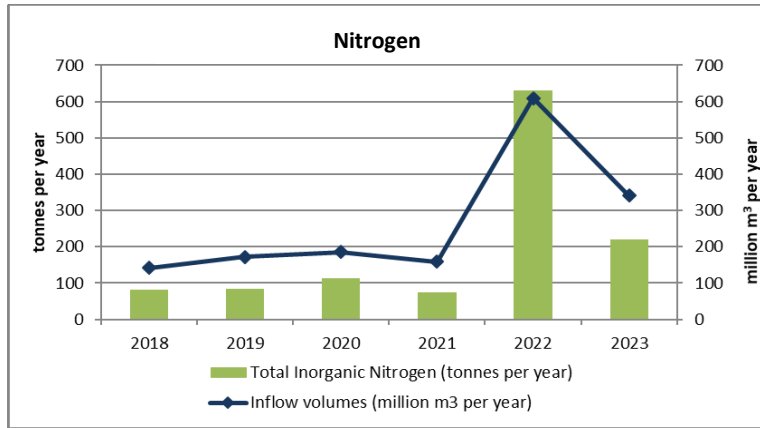
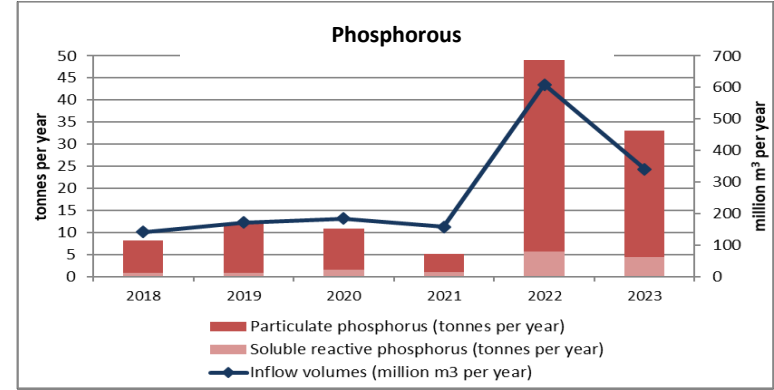
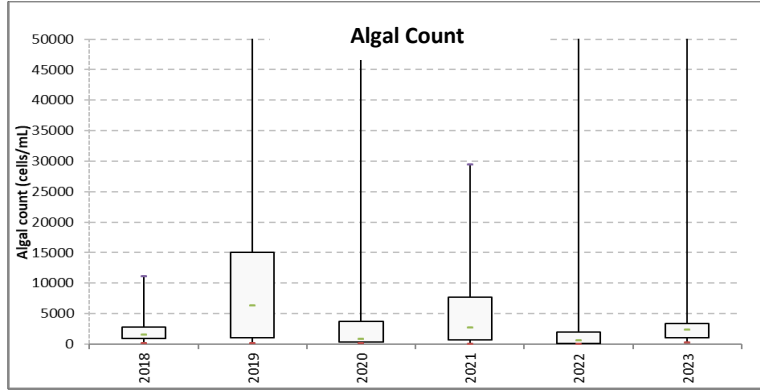

Figure 7.12 Algal response and nutrient loadings for Nagle Dam.

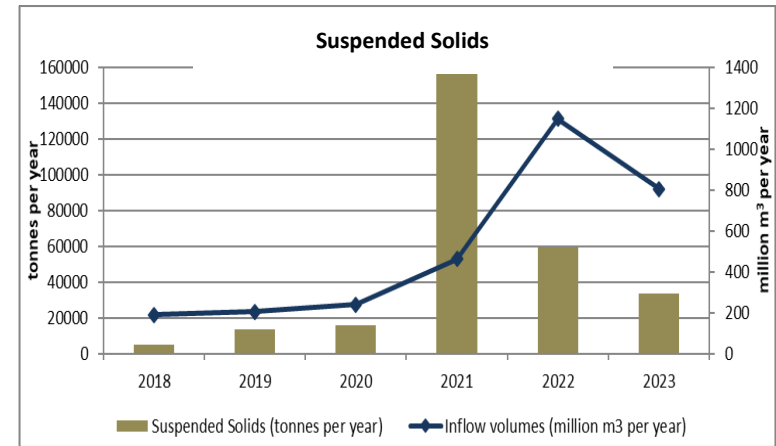
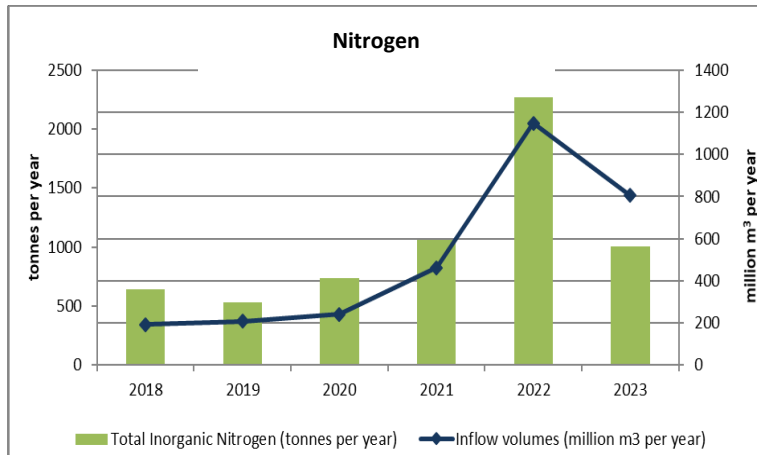
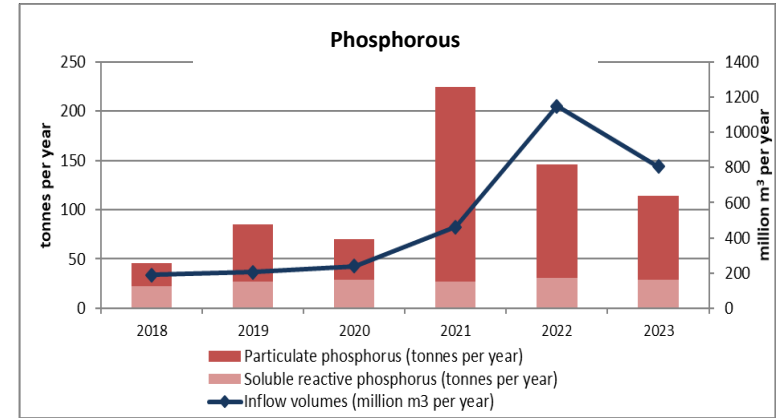
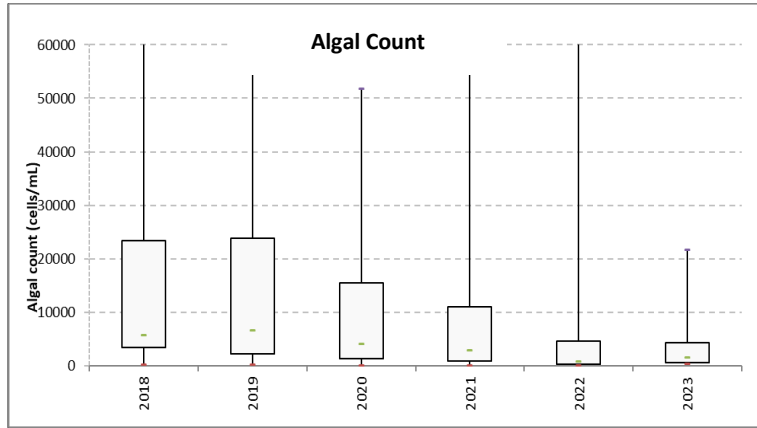

Figure 7.13 Algal response and nutrient loadings for Inanda Dam.

Sewer leakages experienced in the Mpophomeni area have compromised the Mthinzima River water quality. This has had a negative impact on the Midmar dam water quality, as the Mthinzima is one of the tributaries discharging into Midmar dam. The latest algal count results for Midmar Dam depicts an increasing trend thus signifying the impact of the Mpophomeni area inputs amongst other contributors within the catchment area (**Figure 7.14**). uMthinzima River invariably delivers elevated phosphorus, a key variable in the growth of algal blooms.

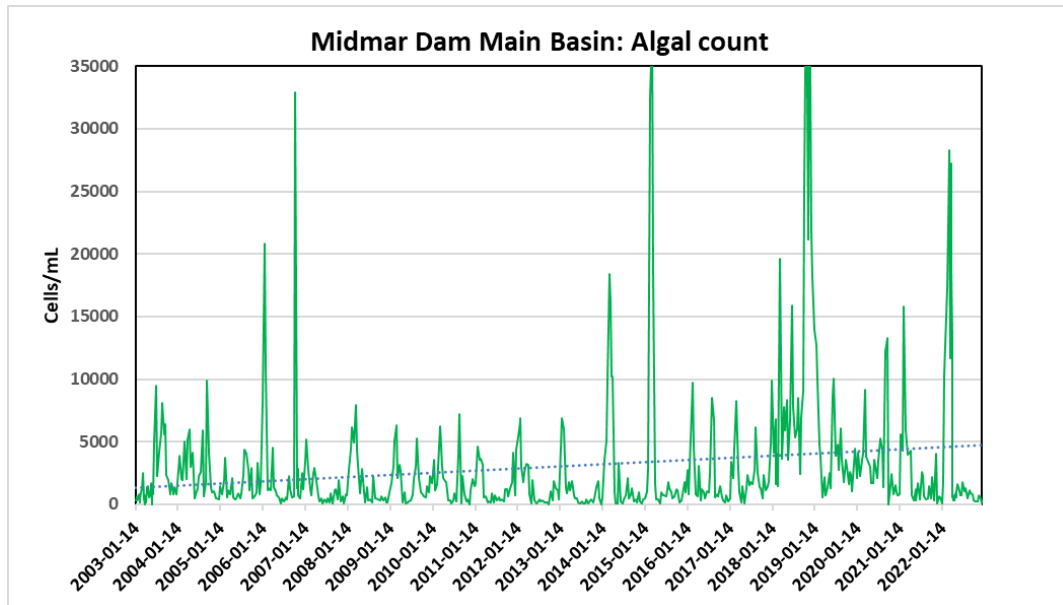

Figure 7.14 Total algal count – Midmar Dam Main basin.

The feasible impact has been largely reduced by the assimilative capacity of the downstream wetland and Midmar dam. The sewage problems experienced at Mpophomeni are largely due to infrastructure related challenges:

- The sewer infrastructure is old and consistently plagued by sewage leakages.
- The sewer lines are prone to storm water ingress thus substantially increasing the volume and triggering leakages.
- Howick WWT is overloaded and unable to consistently accommodate sewage from the Mpophomeni Pumpstation.
- The Mpophomeni Pumpstation capacity is sometimes exceeded. This results in sewage overflows into Mthinzima river.

The water quality status of the Lower Mgeni Catchment, particularly within the Inanda system, has seen a significant decline due to an increased nutrient load. This deterioration in water quality is predominantly a consequence of catchment run-off from the Pietermaritzburg/uMsunduzi area, which carries various contaminants into the Inanda system. A key factor contributing to this issue is the contamination with sewage, primarily resulting from sewer leakages within the region. The regular influx of these pollutants has led to alarming changes in water quality, prompting urgent attention and mitigation efforts.

To monitor and manage this situation, uMngeni-uThukela Water conducts weekly water quality assessments at various sites within the Msunduzi catchment (**Table 7.2**). This comprehensive monitoring approach is crucial for identifying and understanding the extent of the contamination

problems. The data collected from these assessments consistently reveal the significant presence of sewage contamination. The monitoring activities specifically highlight the problematic levels of contaminants being introduced into the water system, thus underlining the need for improved infrastructure and better sewage management practices to protect the water quality.

Table 7.2 Water quality sampling points within Msunduzi catchment.

UUW Code	Sample	Sampling Point	UUW Code	Sample	Sampling Point
RBS001		Baynespruit at Greytown road	RMD011		Msunduzi at Camps Drift bridge
RBS002		Baynespruit	RMD013		Msunduzi u/s of Dorpspruit confluence
RBS003		Baynespruit at Sobantu	RMD014		Msunduzi u/s of Refuse Dump
RDS003		Dorpspruit at polo fields	RMD015		Msunduzi u/s of Darvill WWW
RDS004		Townbush stream at polo fields	RMD016		Msunduzi u/s of Baynespruit
RDS005		Dorpspruit Ohrtmann Road	RMD017		Msunduzi u/s of Darvill Maturation river
RMD006		Msunduzi at Caluza bridge	RMD018		Duzi d/s of Darvill Mat river
RMD007		Msunduzi d/s of Kwapata	RMD019		Msunduzi at Motorcross
RMD008		Msunduzi at Edendale weir by Prison	RSL003		Slangspruit u/s of Msunduzi confluence

A critical indicator used in these assessments is the presence of *E. coli* bacteria, which serves as a marker for sewage contamination. Elevated levels of *E. coli* are directly correlated with the extent of sewage pollution in the water. Recent monitoring data has shown a concerning rise in *E. coli* counts at various river sampling points within the Msunduzi catchment. The percentage number of samples per year recording *E. coli* results greater than 10 000 counts per 100 mL has increased (**Figure 7.15**). The trend line shows that the number of elevated *E. coli* results has increased over the years, particularly in the more recent period. This trend indicates a worsening situation and reflects the ongoing impact of sewer leakages on the water quality. Addressing these contamination challenges requires coordinated efforts to repair the sewer leakages, implement effective waste management strategies, and ensure regular monitoring to safeguard the health of the Inanda system.

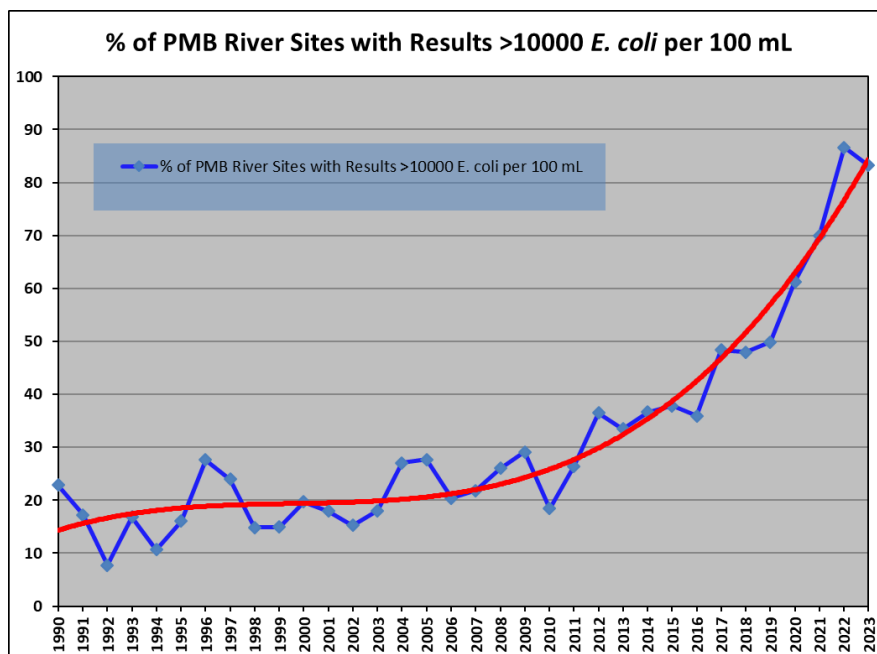

Figure 7.15 Percentage of Msunduzi catchment river sites with *E. coli* results > 10000 per 100 mL.

Nutrient loads assessments were undertaken to quantify the input and possible impact associated with sewage related contamination. To this end, **Figure 7.16** depicts average daily inflows with total Phosphate and ortho-Phosphate loads per annum trends for the Darvill WWW.

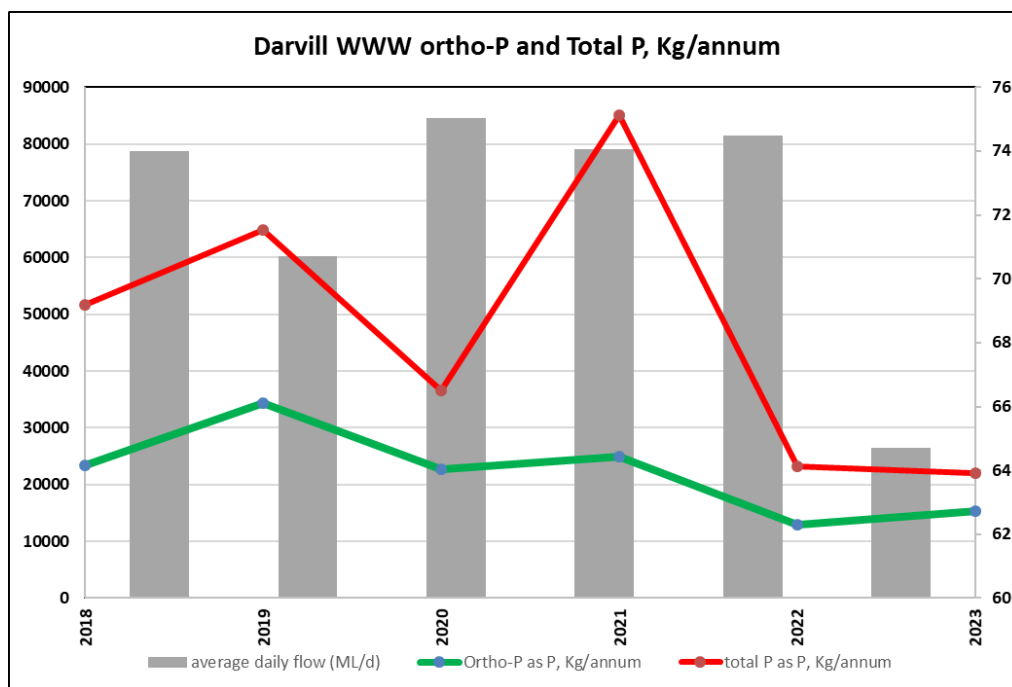

Figure 7.16 Phosphorus loads - Darvill WWW effluent.

Figure 7.16 reflects the phosphate loads for the effluent discharge from Darvill WWW into Msunduzi river. The recent data depicts a decline on amount of phosphate discharged into the river. This is predominantly due to the improved treatment capacity of the plant and the reduced inflow volumes. The Darvill WWW plant upgrade has improved effluent compliance. However, the reduction on the treated volumes confirm the prevailing water resource pollution challenges associated with sewer leakages. The sewage pollution has detrimental impact on the river water quality (Msunduzi River and uMngeni River) and Inanda Dam.

Inanda Dam length, morphology, and assimilative capacity, have played a critical role in minimizing the possible water quality impact. However, the accumulative impact of the persistent sewage contamination has compromised the impoundment water quality. At this stage, the impact on water quality has manifested as follow:

- Elevated nutrients concentration that has caused eutrophication thus increasing algal counts and proliferation of aquatic weeds. Algal related taste and odour challenges have been experienced.
- Reduced oxygen level, reducing the impoundment oxidation potential thus increasing the concentration of dissolved metal ions (i.e. Iron and Manganese).

Consequently, the raw water quality has deteriorated thus increasing the risk associated with the possibility of producing compromised drinking water. Furthermore, the water resource ecological infrastructure has been degraded by sewage contamination. The increased risk linked to drinking water has been addressed through process optimization and dosing of advance treatment chemicals thus increasing the treatment cost.

- **Groundwater**

The ambient water quality of groundwater, in the Mooi/uMngeni Region, is generally excellent. 83% of recorded field observations of electrical conductivity parameters do not exceed a value of 450 µg/ℓ (70 mS/m). It appears that the least saline groundwater is associated with dolerite intrusions (median value of 11 mS/m) and the most saline with the tillite lithology (median value of 56 mS/m).

(b) uMkhomazi Region

(i) Overview

The uMkhomazi River has its source at an elevation of approximately 3 000 m above sea level in the Drakensberg Mountains. The river flows in a south-easterly direction and enters the Indian Ocean near the town of uMkomaas about 40 km south of Durban. Several large tributaries, including the Loteni, Nzinga, Mkomazane, Elands and iXobho rivers flow into the uMkhomazi. The region includes the small towns of Bulwer, Impendle, Ixopo, Mkhomazi, Craigieburn and Magabheni which have small water requirements.

The Department of Water and Sanitation Reconciliation Strategy Study (DWA, 2010) confirmed that the uMkhomazi Water Project, which includes the transfer of water from Smithfield Dam on the uMkhomazi River to the uMngeni System (**Section 7.5.2 (a)**), would be the most feasible for augmenting the water resources of the uMngeni System (**Figure 7.17**). From a hydrological perspective, the uMkhomazi River Catchment comprises the tertiary catchment U10, as shown in **Figure 7.18**. The uMkhomazi River Catchment has a catchment area of 4 387 km². There is an estimated total of almost 1 000 small dams in the catchment with a combined storage of over 30 million m³ (DWS, 2015).

The catchment is currently fairly undeveloped with the main land use activities being commercial forestry and irrigation in the central catchment areas around the towns of Bulwer, Richmond, Ixopo and Impendle. There is a large industrial abstraction for Sappi Saiccor near the coastal town of Umkomaas. Other water users include small towns and rural settlements, stock watering, dry-land sugarcane and invasive alien plants. The catchment is the third largest river in KwaZulu-Natal in terms of mean annual runoff also known as MAR.

(ii) Surface Water

The hydrological characteristics for this region are summarised in **Table 7.3** and **Table 7.4**. This catchment has an annual natural runoff of 1 078 million m³, 67% of which is generated upstream of the proposed Smithfield Dam site. The current net water use within the uMkhomazi River catchment is approximately 159 million m³/a (15% of the total natural MAR of the catchment), and it is estimated that this may grow to 192 million m³/a by 2050 (DWS, 2015).

Table 7.3 Hydrological characteristics of uMkhomazi River catchment (DWS 2015).

Quaternary Catchment	Incremental Area (km ²)	MAP (mm)	MAE (mm)	Incremental Natural MAR		
				(Million m ³ /annum)	(mm/annum)	(% MAP)
U10A	418	1287	1,300	209.52	501	39
U10B	392	1176	1,300	164.49	420	36
U10C	267	1091	1,300	96.70	362	33
U10D	337	999	1,300	98.22	291	29
U10E	327	1034	1,300	100.92	309	30
U10F	379	963	1,300	67.08	177	18
U10G	353	981	1,250	70.12	199	20
U10H	458	924	1,200	82.66	180	20
U10J	505	878	1,200	77.99	154	18
U10K	364	793	1,200	40.42	111	14
U10L	307	758	1,200	29.56	96	13
U10M	280	858	1,200	40.06	143	17
Total	4387	981	1,252	1077.74	246	25

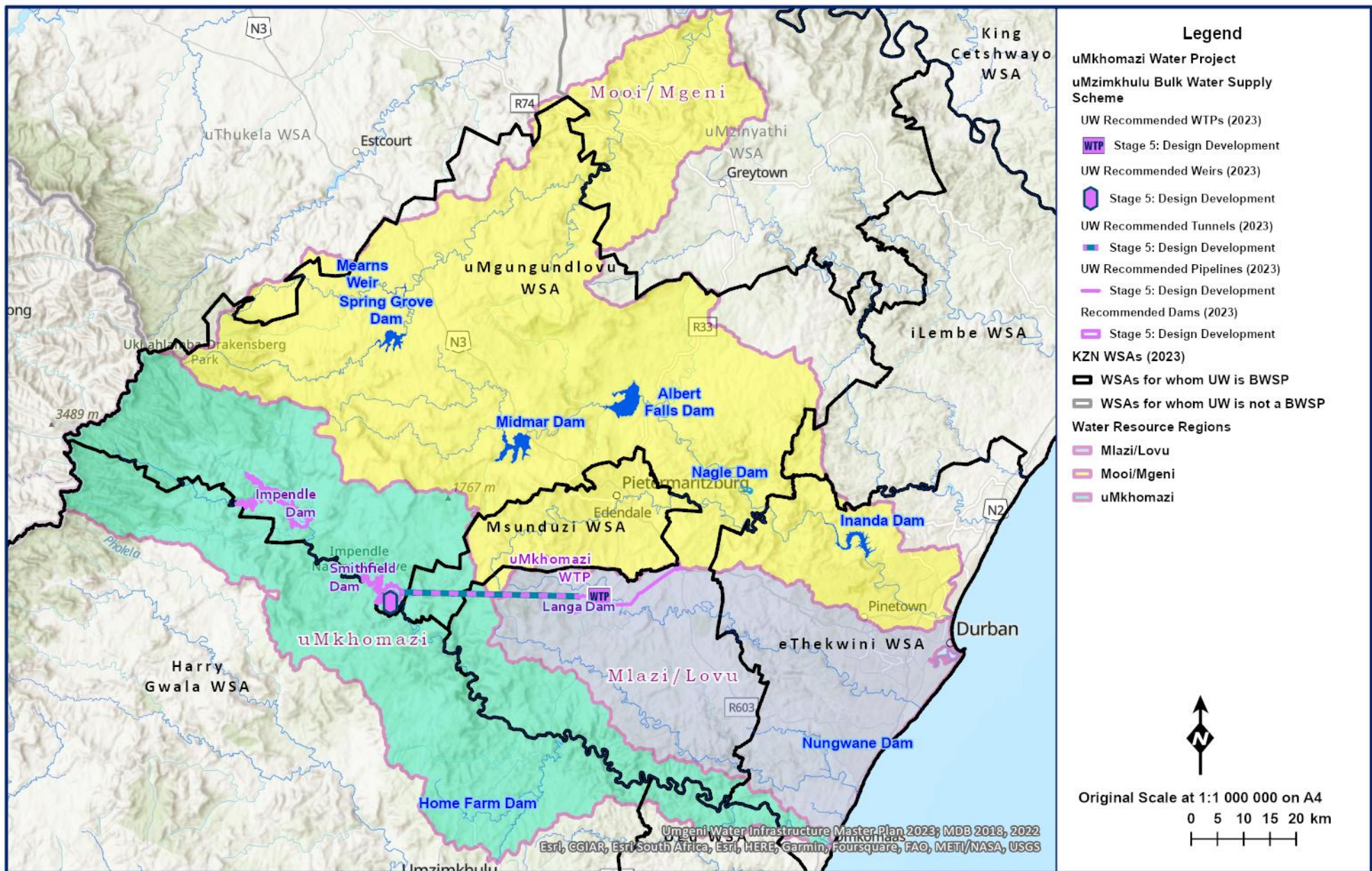

Figure 7.17 Locality map of the uMkhomazi, uMlazi and uMgeni river catchments.

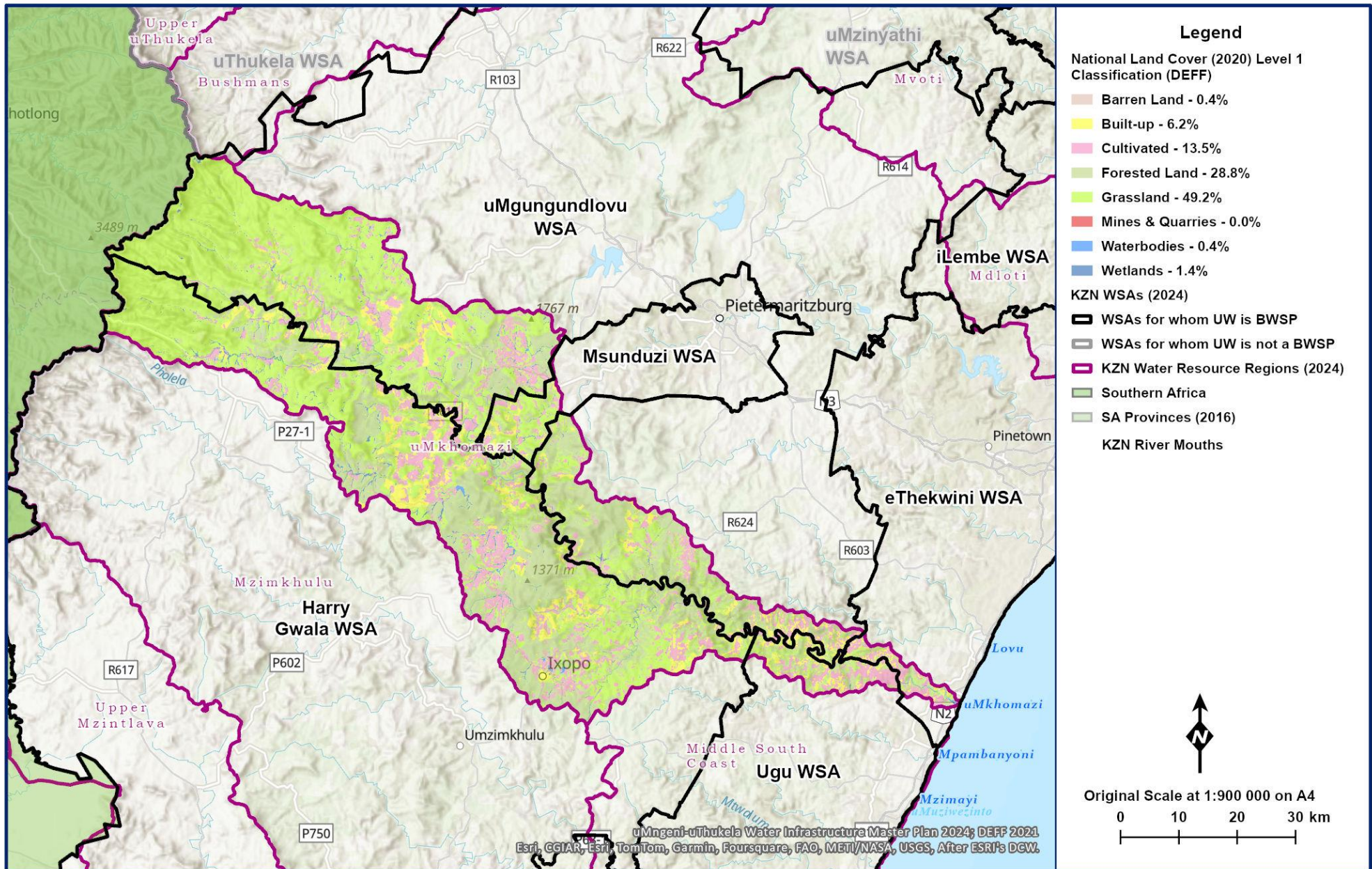

Figure 7.18 General layout of the Mkhomazi Region (DEFF 2020; MDB 2020; UMngeni-uThukela Water 2022; WR2012).

Table 7.4 Hydrological characteristics of the uMkhomazi Region (uMngeni-uThukela Water 2002 and DWA 2013).

Region	River (Catchment)	Incremental Area (km ²)	Annual Average			
			MAE (mm)	Rainfall (mm)	Natural Runoff (million m ³ /annum)	Natural Runoff (mm)
Mkhomazi	Impendle	1,422	1,300	1,138	567.9	399.4
	Smithfield	632	1,300	1,017	163.2	258.2
	Ngwadini	2,242	1,200	875	324.5	144.7
	Mkhomazi Estuary	91	1,200	855	11.3	124.2
	Luhane	46.3	1,361	980	7.5*	161.9

* Present day MAR

(iii) Groundwater

The Mkhomazi Region occurs in the KwaZulu-Natal Coastal Foreland and Northwestern Middleveld Groundwater Regions (**Section 2**). As such this Groundwater Region is characterised by a combination of intergranular and fractured arenaceous rocks.

• Hydrogeological Units

The hydrogeologically relevant lithologies recognised in the Mkhomazi Region comprise sandstone, tillite and mudstone/shale supporting fractured groundwater regimes and dolerite intrusions and granite/gneiss supporting fractured and weathered groundwater regimes.

• Geohydrology

The Dwyka Tillite formation has the smallest coverage in comparison to the other lithological units in the catchment (**Figure 7.19**). It occurs just south of Richmond where it lies exposed in the river banks of uMkhomazi. The Ecca Group is represented by the mudstones/shale of the Pietermaritzburg, Vryheid and Volksrust Formation. The foothills of the Drakensberg Mountains at the head of uMkhomazi River and the central areas of the catchment are dominated by these lithologies. These lithologies support marginal to poor borehole yields (0.1 – 0.5 ℓ/s). However, the presence of extensive intrusive dolerite in the form of sheets and dykes has greatly enhanced the potential of the mudstones to store and yield groundwater.

• Groundwater Potential

Primary groundwater supplies using boreholes fitted with hand pumps, wind pumps or submersibles are obtainable in most of the lithological units. The exceptions are the Dwyka formation (tillites) or massive granites. In these areas groundwater supply could be obtained within an adjacent fault valley where the potential for high yielding boreholes is much enhanced (**Figure 7.19**).

The sandstone of the Natal Group represents the most productive groundwater-bearing lithology, followed by mudstone/shale lithologies, the granite/gneiss lithologies and the tillite sediments of the Dwyka Tillite Formation.

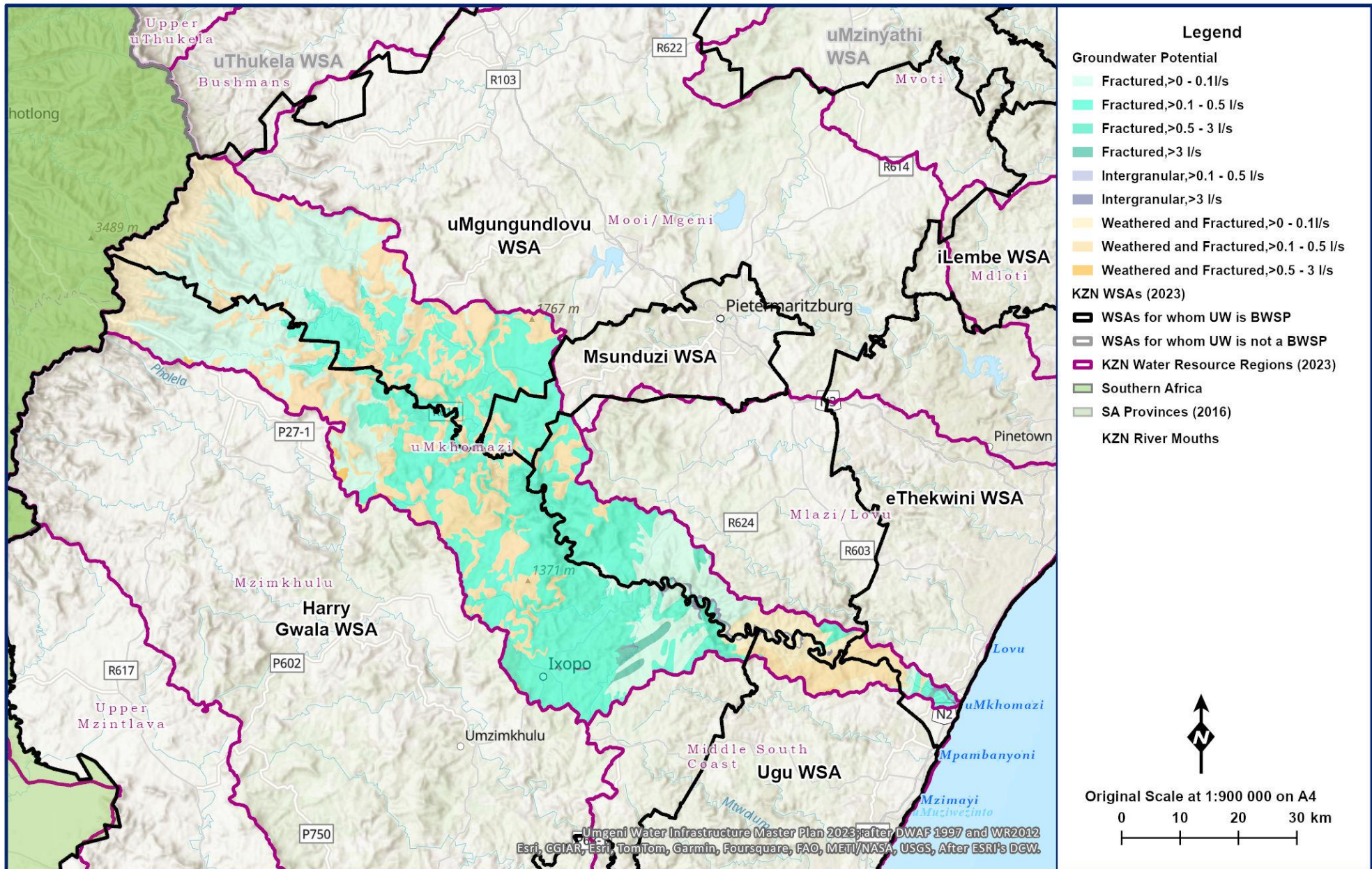

Figure 7.19 Groundwater potential in the Mkhomazi Region (after DWA 1997 and WR2012, MDB 2020, Umgeni-uThukela Water 2022).

Boreholes favourably located in the Natal Group Sandstone (NGS) provide good yields. Yields of 3 ℓ/s (greater than 10 000 ℓ/hr) are not uncommon where large scale fracturing/faulting provide conduits for groundwater movement

Boreholes located in metamorphic lithologies (gneisses) indicate yield characteristics in the range 0.1 to 0.5 ℓ/s, with a median value of 0.3 ℓ/s.

(iv) Water Quality

There is decreasing trend in algal responses is observed at Home Farm Dam, however in 2023 there is a slight increase (**Figure 7.20**). The decrease is possibly associated with dilution factor emanating from higher flows.

Nutrient and suspended solids loads calculations is presently not feasible for this system. The absence of flow measuring devices at Home Farm Dam inflow negates quantification of the nutrients loads discharged into Home Farm Dam.

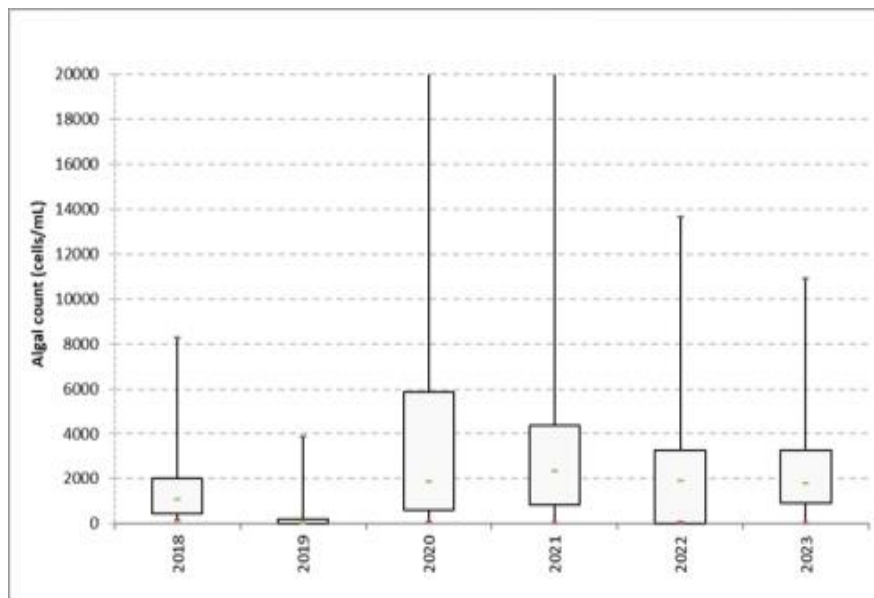

Figure 7.20 Algal response for Home Farm Dam.

7.2.2 Reserve

(a) Mooi/uMngeni Water Resource Region

The quantity component of the Ecological Reserve for the uMngeni catchment has not yet been determined. The DWS (2016) study only determined the ecological classes in terms of present and target ecological classes. However, estimates of the Ecological Reserve indicate that the Ecological Reserve will have a large impact on the availability of water in the catchment. Considering that the catchment is already stressed, the determination and implementation of the Ecological Reserve will require careful consideration.

Estimates of environmental flow requirements represented as compensation flows released from the main dams in the uMngeni System are indicated in **Table 7.5**. As with the IFRs, the estuarine flow requirement (EFR) of the uMngeni River also has not been determined in a comprehensive manner.

Table 7.5 Summary of environmental (compensation) flow requirements.

Description	Simulated Compensation Flow	
	(m ³ /s)	(million m ³ /annum)
Midmar Compensation	0.900	28.40
Albert Falls Compensation	0.710	22.41
Inanda Compensation	1.500	47.34
uMngeni EFR	1.426	45.00

Present Ecological State (PES) represents how the ecological condition of a river has been modified from its natural conditions. The measure is based on water quality variables, biotic indicators and habitat information that has been collected. Results are classified on a 6-point scale, from Category A (Largely Natural) to Category F (Critically Modified). Target ecological category (TEC) represents improvements that must be done on the ecological condition of the river based on flow or non flow related issues.

The PES of various rivers in the Mooi/uMngeni Region is detailed in the report (DWS 2016). The target ecological categories (TEC) of various rivers in the Mooi/uMngeni Region are in DWS, 2016. Various river nodes in the Greater Mooi/uMngeni Region require improvements as a result of non-flow-related/anthropogenic issues. If the REC is attainable then it has been included in the catchment configuration.

As part of the KZN Water Reconciliation Study (DWA 2011) to assess the impacts of re-utilising treated wastewater, a rapid reserve determination for the uMngeni River estuary was undertaken. The present ecological status of the estuary was found to be a Class E which indicates that it is highly degraded. The study shows that the estuary importance score is 82 which means that it is a highly important estuary. The study recommends that the ecological status of the uMngeni estuary should be improved to at least a category D.

The classes of water resources and resource quality objectives for the catchments of Mvoti to Mzimkhulu were published in the government gazette in 2017. Apart from the uMngeni System, other river systems classified included Mvoti, uMkhomazi, Umzimkhulu and Mtanvuna. This classification resulted from the findings of DWS (2016) study, and for uMngeni River these are as follows:

- The current present ecological state is recommended for the main uMngeni River.
- The uMngeni River between Midmar and Albert Falls has a Present Ecological Class of C and Recommended Ecological Class of C.
- The uMngeni River between Nagle and Inanda has a Present Ecological Class of C/D and a Recommended Ecological Class of C/D.
- uMngeni River Estuary has a Present Ecological Status of E and a Recommended Ecological Class of D.

A detailed assessment of the Ecological Reserve for the entire uThukela catchment was undertaken in 2004, and this included the Mooi River catchment. This assessment indicated an over allocation of water, particularly on the Little Mooi River. In order to ensure that the correct Reserve flows are maintained in the Little Mooi River, an approximate 50% curtailment of the existing registered irrigation and afforestation is required. Additionally, all existing farm dams will be required to release their rightful share of the Reserve. Currently none of these dams are contributing to the Reserve. Hence a compulsory licensing process will need to be completed by DWS before the Reserve can be fully implemented in the Mooi catchment.

The necessary river outlets have been included into the design of Spring Grove Dam to ensure that it will be able to release the required volumes of water needed for the Reserve.

(b) Mkhomazi Water Resource Region

No comprehensive assessment, using the accepted standardised methodology, has been undertaken of the ecological Reserve of uMkhomazi River to date. A Reserve determination was undertaken in the late 1990's as part of the pre-feasibility investigations into a transfer scheme from uMkhomazi to uMngeni catchment. The DWS (2016) study found that the present ecological state of the uMkhomazi River is in a B class in the upper reaches and a C class in the lower reaches. These ecological classes are also recommended for the proposed Mkhomazi-uMngeni Transfer Scheme, also known as the uMkhomazi Water Project (Section 7.5.2 (a)). It was estimated that 350 million m³/a (32%) of the catchment runoff should be earmarked for ecological water requirements to sustain the system's riverine health at a desirable level should the uMWP be implemented (DWS, 2015).

Taking into account the current conditions of the estuary with a present ecological class of a C, the reversibility of the current impacts and the ecological importance and the conservation requirements of the uMkhomazi Estuary, the current recommendation is for an ecological Class B category.

The present ecological state (PES) of various rivers in the Mkhomazi Region is detailed in the DWS report (DWS, 2016). The targeted ecological categories (TEC) of various rivers in the Mkhomazi Region are in the report. Various nodes require improvements as a result of non-flow-related/anthropogenic issues. If the REC is attainable then it has been included in the catchment configuration.

7.2.3 Climate Change Impacts

In August 2019, uMngeni-uThukela Water updated a 2012 study that investigated the potential impacts of climate change on the Mooi/uMngeni, Mkomazi, Mlazi/Lovu, Mdloti and Mvoti water resource regions. The 2019 study used ten selected Global Circulation Models (GCMs) from Phase 5 of the Coupled Model Intercomparison Project (commonly referred to as CMIP5). The results and recommendations of this report are summarised in **Table 7.6**.

Table 7.6 uMngeni-uThukela Water 2019 Climate Change Study results and recommendations (2019: 54 – 56).

Variable	Results and Recommendations
Reference potential evaporation (E_r)	Historical annual evaporation values range between 1 500 mm and 2 000 mm. The climate projections for the 2030s and 2040s show increases between 60 and 100 mm, which are equivalent to 2 – 3% evaporation increase along the coast and approximately 10% evaporation increase along the Drakensberg. The seasonal reference potential evaporation (E _r) ranges from 200 mm in winter to 600 mm in summer. Potential evaporation constitutes a loss from surfaces of dams, wetlands and riparian zones and this loss is expected to increase beyond the 2040s. The E _r increases will further result in soils drying out more quickly with potential consequences on runoff production. Irrigation water demands will further be higher, potentially affecting uMngeni-uThukela Water, as abstractions from dams will increase and river flows will reduce where irrigation is from run-of-river.
Annual and seasonal rainfalls	The results of the assessment of the season confidence indices of the projected changes between present and immediate future rainfalls showed that: <ul style="list-style-type: none"> i) For a given season, confidence in results is lowest in dry years and highest in wet years. ii) Confidence in results varies with season, being lowest in winter, second lowest in autumn and highest in spring.
Dry spells of short and medium duration	Dry spells of short and medium duration result in increases in irrigation water requirements and reduction in runoff. The projections from the GCMs used indicate that there will be more dry spells of two and three consecutive months' duration over the next 30 years occurring in the higher lying western areas, which are the source areas of the major rivers.
Wet spell analysis	The projected reduction, per annum, in wet spells in the west, especially those of two and three months' duration, implies fewer runoff-producing events in the headwater catchments of the major rivers. This reduction in wet spells further implies that increases in irrigation water requirements will likely occur in the future. There are projected increases in wet spells in the areas along the coast. The projections from the CORDEX GCMs used showed that in the west, an area that is a critical source of water to the region, there will be both <i>increases</i> in dry spells and simultaneous <i>decreases</i> in wet spells.
Streamflows at annual and seasonal durations	The results noted that the confidence in the changes of streamflows into the future are not that high. The findings showed that projected changes in streamflows for three of the four seasons of the year are negative i.e. flow reductions may be expected. The results further showed that annual streamflow years with median flows are also projected to have lower flows into the future, while for both 1 : 10 year dry and wet years a mix of reductions and enhancements in streamflows is projected within different parts of the water resource regions.
Design rainfall	The report noted a number of limitations on the design rainfall and that confidence in the design hydrology analyses were unlikely to be as high as for other hydrological variables. The results from the GCMs showed that inland areas are projected to display increases in design rainfall ranging from approximately 20% to approximately 40% in 30 years' time. It was recommended that the designs of inland infrastructure could be increased and that any development should be kept away from river buffer zones. It was further recommended that, while projections along the coastal zone indicate lower design rainfalls into the future, no lowering of design standards should be considered. It was noted that design streamflows displayed different spatial patterns to those of design rainfalls as design rainfalls were computed for individual quinary catchments while design streamflow considered flows from the entire area upstream of the point of interest.
Design streamflows	Similar to design rainfall, a number of limitations were noted. However, the overall projection was that design streamflows will increase and this could pose new challenges for uMngeni-uThukela Water in engineering designs. The recommendation to consider is to possibly err on the conservative side by including a climate change related margin of safety to all new hydraulic structures, even where results show no enhancement due to climate change. This recommendation is based on the premise that structures are designed to operate safely into an era well beyond that of a future in which hydrological stationarity of the past can be assumed.

7.2.4 Existing Infrastructure and Yields

(a) Mooi/uMngeni Water Resource Region

There are four major dams on the uMngeni River, namely Midmar (**Figure 7.21**), Albert Falls (**Figure 7.22**), Nagle (**Figure 7.23**) and Inanda (**Figure 7.24**) dams. These dams are all used as part of the water supply system. The characteristics of these dams are summarised in **Table 7.7**, **Table 7.8**, **Table 7.9**, and **Table 7.10** respectively. The silt surveys for dams in the Mooi/uMngeni System should be undertaken every 15 years.

As part of the Mooi/uMngeni Transfer Scheme, water is pumped from either Spring Grove Dam or Mearns Weir located in the Mooi River catchment. The characteristics of Mearns Weir and Spring Grove Dam (**Figure 7.25** and **Figure 7.26**) are summarised in **Table 7.11**, and **Table 7.12**.

Henley Dam (**Figure 7.27** and **Table 7.13**), situated on the Msunduzi River, a tributary of uMngeni River is no longer used for water supply purposes. All significant dams within the Mooi/uMngeni Region are listed in **Table 7.15**.

Raw water is supplied from Midmar Dam under gravity to DV Harris WTP, and under pumping (8 m lift) to Midmar WTP. Water is released from Albert Falls Dam to Nagle Dam from where it is supplied under gravity to Durban Heights WTP. Raw water is supplied from Inanda Dam under gravity to Wiggins WTP. It is possible to pump water from Inanda Dam to Durban Heights WTP utilising two different pump sets, viz. the 'Shaft' pumps, comprising three pumps capable of delivering a maximum of 140Mℓ/day with one standby, and the 'Inanda' pumps, comprising two pumps capable of delivering a maximum of 120Mℓ/day. An average of 136Mℓ/day was pumped from the 'Shaft' pumps in the year 2023. However, pumping from Inanda Dam Pump Station was not possible over the last six months due to a refurbishment project on the rising main.

Under normal conditions, it is possible to pump a total of 260Mℓ/day from Inanda Dam to Durban Heights WTP. A fourth Shaft Pump, delivering 40Mℓ/day can increase the total pumping capacity to approximately 280Mℓ/day although this could impact scheduled maintenance and operational flexibility and hence the maximum delivery is limited to 240Mℓ/d.

Pumping from Mooi River into Midmar Dam was suspended at the beginning of January 2024 when the system reached full supply capacity. However, it is anticipated that it will resume sometime in April 2024 when the Upper uMngeni System dams drop below full supply level. Other than Mearns Weir and Spring Grove Dam, there is one additional major dam in the catchment, i.e. Craigieburn Dam on the Mnyamvubu River, which is a tributary of the Mooi River. Craigieburn Dam is owned and operated by DWS. It has a capacity of 23.5 million m³ and mainly supplies water to approximately 2000 ha of predominantly citrus farming irrigation downstream of the dam and along the Mooi River at Muden. There is also an intention to supply water from this dam to Greytown for treatment and potable distribution. Bulk Conveyance between CraigieBurn Dam is partly completed and about 4.2km of the delivery pipeline from the CraigieBurn Pumpstation remains incomplete. There is an abundance of farm dams in the Mooi catchment, especially in the upper reaches.

The yield information of the existing water resources infrastructure was revised in 2019 based on a re-evaluation of the hydrology of both Mooi and uMngeni catchments and is presented in Table 7.15.

- The yield results from UUW (2019) were based on improved calibration of rainfall runoff modelling. Changes in yield values, when compared against previous studies, are as a result of additional rainfall and runoff data as well as revised land-use data. Good calibrations improved

the confidence in the hydrology records and also resolved some imbalance issues noted in the previous models used to simulate the uMngeni system.

- A key recommendation of the study was that available yield volumes, determined for the dams in the Mooi-uMngeni System, should be reduced by raw water conveyance losses when compared with the potable water requirements of the system. The Midmar System showed minimal raw water losses whilst the Nagle System showed losses of up to 8% and the Inanda System a 5% loss for raw water conveyance.
- When these raw water conveyance losses are applied to the yields, the resultant yields come back to the ball park of what they were before, therefore the yield figures have not been changed on the supply systems.



Figure 7.21 Midmar Dam.

Table 7.7 Characteristics of Midmar Dam (DWS 2003; 2016a).

Catchment Details	
Incremental Catchment Area:	926 km ²
Total Catchment Area:	926 km ²
Mean Annual Precipitation:	1 011 mm
Mean Annual Runoff:	209.4 million m ³
Annual Evaporation:	1 300 mm
Raised Dam Characteristics	
Gauge Plate Zero:	1 021.7 mASL
Full Supply Level:	1 047.5 mASL
Spillway Height:	25.8 m
Net Full Supply Capacity:	235.414 million m ³
Dead Storage:	0.0 million m ³
Total Capacity:	235.414 million m ³
Surface Area of Dam at Full Supply Level:	17.93 km ²
Original Measured Dam Capacity	177.347 million m ³ (October 1963)
Second Measured Dam Capacity	177.113 million m ³ (October 1983)
Third Measured Dam Capacity	235.414 million m ³ (January 2003)
Dam Type:	Concrete gravity with earth embankments
Crest Length:	Spillway Section: 139.6 m Non-Spillway Section: 1 283.4 m
Type of Spillway:	Uncontrolled
Capacity of Spillway:	3 500 m ³ /s
Date of Completion:	1963
Date of Area Capacity Survey:	2003 – Year when the wall was raised
Date of next Area Capacity Survey:	2024 (DWS survey almost complete)



Figure 7.22 Albert Falls Dam.

Table 7.8 Characteristics of Albert Falls Dam (DWS 1993; 2016b).

Catchment Details	
Incremental Catchment Area:	728 km ²
Total Catchment Area:	1 654 km ²
Mean Annual Precipitation:	1 005 mm
Mean Annual Runoff:	131.1 million m ³
Annual Evaporation:	1 200 mm
Dam Characteristics	
Gauge Plate Zero:	634.3 mASL
Full Supply Level:	655.9 mASL
Spillway Height:	21.6 m
Net Full Supply Capacity:	289.133 million m ³ (March 1993)
Dead Storage:	0.975 million m ³
Total Capacity:	290.108 million m ³
Surface Area of Dam at Full Supply Level:	23.5 km ²
Original Measured Dam Capacity	289.4620 million m ³ (June 1974)
Second Measured Dam Capacity	289.167 million m ³ (March 1983)
Third Measured Dam Capacity	289.133 million m ³ (March 1993)
Dam Type:	Concrete with earth embankments
Crest Length:	Spillway Section: 100 m Non-Spillway Section: 1 930 m
Type of Spillway:	Uncontrolled
Capacity of Spillway:	3 447 m ³ /s
Date of Completion:	1976
Date of Area Capacity Survey:	2008
Date of next Area Capacity Survey:	2028



Figure 7.23 Nagle Dam.

Table 7.9 Characteristics of Nagle Dam (DWS 2004; uMngeni-uThukela Water 2015).

Catchment Details	
Incremental Catchment Area:	885 km ²
Total Catchment Area:	2 539 km ²
Mean Annual Precipitation:	940 mm
Mean Annual Runoff:	139.7 million m ³
Annual Evaporation:	1 200 mm
Dam Characteristics	
Gauge Plate Zero:	379.71 mASL
Full Supply Level:	403.81 mASL
Spillway Height:	24.1 m
Net Full Supply Capacity:	23.237 million m ³ (November 1987)
Dead Storage:	1.366 million m ³
Total Capacity:	24.6 million m ³
Surface Area of Dam at Full Supply Level:	1.56 km ²
Original Measured Dam Capacity	23.237 million m ³ (October 1963)
Second Measured Dam Capacity	23.237 million m ³ (November 1987)
Dam Type:	Concrete gravity dam
Crest Length:	Spillway Section: 121 m Non-Spillway Section: 272 m
Type of Spillway:	Uncontrolled
Capacity of Spillway:	4334 m ³ /s
Date of Completion:	1948
Date of Area Capacity Survey:	1987
Date of next Area Capacity Survey:	2025



Figure 7.24 Inanda Dam.

Table 7.10 Characteristics of Inanda Dam (DWS 1990).

Catchment Details	
Incremental Catchment Area:	618 km ²
Total Catchment Area:	4 082 km ²
Mean Annual Precipitation:	870 mm
Mean Annual Runoff:	60.1 million m ³
Annual Evaporation:	1 200 mm
Dam Characteristics	
Gauge Plate Zero:	115.8 mASL
Full Supply Level:	147.0 mASL
Spillway Height:	31.2 m
Net Full Supply Capacity:	241.685 million m ³ (April 2009)
Dead Storage:	9.964 million m ³
Total Capacity:	251.649 million m ³
Surface Area of Dam at Full Supply Level:	14.63 km ²
Original Measured Dam Capacity	258.677 million m ³ (October 1988)
Second Measured Dam Capacity	251.649 million m ³ (October 1990)
Dam Type:	Concrete with earth embankments
Crest Length:	Spillway Section: 140 m Non-Spillway Section: 468 m
Type of Spillway:	Uncontrolled
Capacity of Spillway:	4 000 m ³ /s
Date of Completion:	1989
Date of Area Capacity Survey:	2009
Date of next Area Capacity Survey:	2025



Figure 7.25 Mearns Weir.

Table 7.11 Characteristics of Mearns Weir (DWS, 2003).

Catchment Details	
Incremental catchment area	242 km ²
Total catchment area	887 km ²
Mean annual precipitation	857 mm
Mean annual runoff	44.12 million m ³
Annual evaporation	1 350 mm
Weir Characteristics	
Gauge plate zero	1375.11 mASL
Full supply level	1382 mASL
Spillway Height:	6.89 m
Original & Current Net full supply capacity	5.116 million m ³ (October 2003)
Dead storage	0.0 million m ³
Total capacity	5.116 million m ³
Surface area of weir at full supply level	2.375 km ²
Weir type	Concrete
Material content of a weir wall	Concrete
Crest length	165m
Type of spillway	Uncontrolled
Capacity of spillway	1 970 m ³ /s
Date of Completion:	2003*
Date of Area Capacity Survey:	2003
Date of next Area Capacity Survey:	2025

*Construction of the initial weir completed in 1983



Figure 7.26 Spring Grove Dam.

Table 7.12 Characteristics of Spring Grove Dam (DWS 2013; uMngeni-uThukela Water 2013).

Catchment Details	
Incremental Catchment Area:	339 km ²
Total Catchment Area:	339 km ²
Mean Annual Precipitation:	1007 mm
Mean Annual Runoff:	131 million m ³
Annual Evaporation:	1 350 mm
Dam Characteristics	
Gauge Plate Zero:	1407.1 mASL
Full Supply Level:	1433.5 mASL
Spillway Height:	26.4 m
Original & Current Net Full Supply Capacity:	139.5 million m ³ (November 2013)
Total Capacity:	139.5 million m ³
Surface Area of Dam at Full Supply Level:	10.2 km ²
Dam Type:	Concrete with earth embankment
Crest Length:	Spillway Section: 70 m Non-Spillway Section: 231 m
Type of Spillway:	Uncontrolled
Capacity of Spillway:	1970 m ³ /s
Date of Completion:	2013
Date of Area Capacity Survey:	2013
Date of next Area Capacity Survey:	2028 (Every 15 years)



Figure 7.27 Henley Dam.

Table 7.13 Characteristics of Henley Dam (uMngeni-uThukela Water 2017).

Catchment Details	
Incremental Catchment Area:	219 km ²
Total Catchment Area:	219 km ²
Mean Annual Precipitation:	940 mm
Mean Annual Runoff:	42.1 million m ³
Annual Evaporation:	1 200 mm
Dam Characteristics	
Gauge Plate Zero:	900 mASL
Full Supply Level:	923.3 mASL
Spillway Height:	23.3 m
Net Full Supply Capacity:	1.02 million m ³ (January 2019)
Dead Storage:	0.0 million m ³
Total Capacity:	1.02 million m ³
Surface Area of Dam at Full Supply Level:	0.3 km ²
Original Measured Dam Capacity	2.72 million m ³ (1942)
Second Measured Dam Capacity	5.87 million m ³ (1960)
Third Measured Dam Capacity	5.51 million m ³ (June 1983)
Fourth Measured Dam Capacity	5.41 million m ³ (November 1987)
Fifth Measured Dam Capacity	1.5 million m ³ (October 1993)
Sixth Measured Dam Capacity	1.02 million m ³ (January 2019)
Dam Type:	Concrete with earth embankment
Crest Length:	Spillway Section: N/A Non-Spillway Section: N/A
Type of Spillway:	Uncontrolled
Capacity of Spillway:	N/A
Date of Completion:	1942
Date of Area Capacity Survey:	2019
Date of next Area Capacity Survey:	2024 (Every 5 years)

Table 7.14 Existing Dams in the Mooi/uMngeni Region.

Impoundment	River	Capacity (million m ³)	Purpose
Spring Grove Dam	Mooi	139.5	Domestic
Craigie Burn Dam	Mnyamvubu	23.5	Irrigation
Mearns Weir	Mooi	5.1	Domestic
Midmar Dam	uMngeni	235.4	Domestic
Albert Falls Dam	uMngeni	289.1	Domestic
Nagle Dam	uMngeni	23.2	Domestic
Inanda Dam	uMngeni	241.7	Domestic

Table 7.15 Yield Information for the existing water resource infrastructure in the Mooi/uMngeni Region including transfers from the MMTS.

Phase	Position in system	Historic Firm Yield	Stochastic Yield (1 in 50 years risk of failure)		Stochastic Yield (1 in 100 years' risk of failure)	
			million m ³ /annum	Mℓ/day	million m ³ /annum	Mℓ/day
-	-	million m ³ /annum	million m ³ /annum	Mℓ/day	million m ³ /annum	Mℓ/day
MMTS	Midmar Dam	167	195.0	534.0	183.0	501.4
	Nagle Dam	277	348.0	953.4	333	912.3
	Inanda Dam	416	446.0	1221.9	434	1189.0

Note: Yields indicated above are obtained from the UJW Report *MGENI-MOOI SYSTEM HYDROLOGY UPDATE STUDY, 2019*.

Note that these yield figures represent volumes of water that can be abstracted from the dams and they do not consider the losses of water that occurs within the raw water bulk infrastructure.

Groundwater is mainly utilised in the uMngeni catchment by private landowners as the majority of towns are supplied by reticulated surface water. Groundwater is utilised to supplement irrigation and for stock watering. The exception is the Nottingham Road and Rosetta areas which are supplied by production boreholes. Very high yielding boreholes (140 kℓ/hr) have been drilled in the area. The contact zones between the shale's, sandstone and the intrusive dolerite dykes are the water bearing features in the areas. There are no faults or other structural features to target. In the Howick area groundwater is abstracted and bottled for commercial purposes. Although not accurately known it has been reported that the formal settlement of Mfolweni currently obtains their domestic water supply (in the order of 2 000 kℓ/day) from boreholes.

7.2.5 Operating Rules

(a) Mooi/uMngeni Water Resource Region

The uMngeni and Mooi River Systems are relatively complex in terms of their operation. In addition to the four dams, the uMngeni River System is augmented from the Mooi River System using the MMTS. The dams on the uMngeni River supply water directly to demand centres via various routes, allowing for flexibility in terms of the operation of the system (refer to description in the previous section and to the system schematic (**Figure 7.28**)).

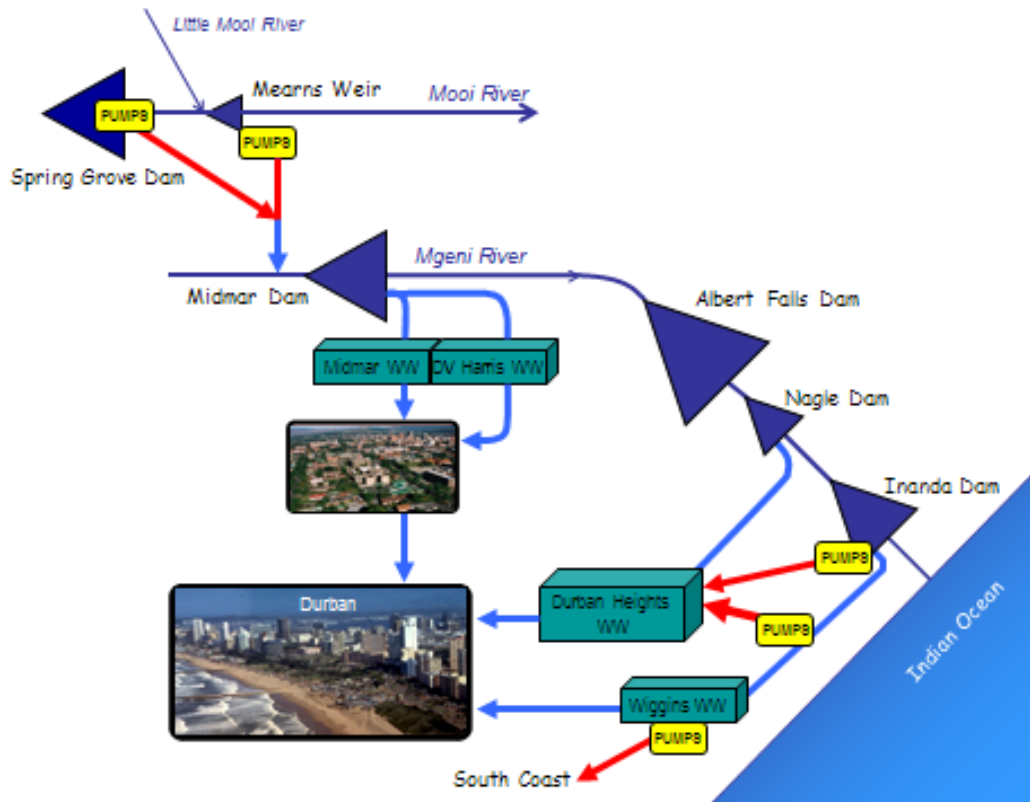

Figure 7.28 Schematic of the uMngeni System.

The area of Verulam, to the north of Durban, can be supplied from either the uMngeni System or from the Mdloti system (**Section 12**). The source of water to this area is determined through operational requirements and the water resource availability in the systems. There is also a linkage from the uMngeni System through to the Upper and Middle South Coast Regions. Water from the uMngeni System is utilised to supplement the supply from the local sources to this area (**Section 11**).

In years when the system storage is full or near full the uMngeni System demands are supplied under gravity (i.e. not utilising the pumps at Spring Grove Dam, Mearns Weir and Inanda Dam). However, if there is a risk of the system being depleted or if demands exceed the yield of the system a revised operating rule is implemented. In this instance, the cost of pumping becomes a secondary consideration. This revised operating rule targets the maximum utilisation of the resource, through pumping at any time of the year, as long as there is excess water to pump from the donor catchment and is defined as follows:

- If Spring Grove Dam is below full supply level and Mearns Weir is above 50% of full supply capacity, then pumping through the MMTS is undertaken from Mearns Weir. This minimises the risk of water flowing over Mearns Weir and less water is lost from the Mooi System in this way. Pumping can also be augmented from the Spring Grove Pump Station to increase the volume pumped to a full $4.5\text{m}^3/\text{s}$.
- Pumping of greater than $4.5\text{m}^3/\text{s}$ is not recommended as this can result in an environmental impact on the receiving streams.
- If Spring Grove Dam is full or likely to spill then pumping through the MMTS is undertaken from the Spring Grove Pump Station which has a lower operating cost.
- Pumping through the MMTS is maximised until Midmar Dam and Albert Falls Dam reach full or near full supply capacity.

- Pumping from Mooi River is stopped when the uMngeni System is full or approaches full supply capacity with good rains predicted.
- Water is released from Albert Falls Dam to Nagle Dam from where water flows under gravity to the Durban Heights WTP.
- If Nagle Dam is spilling, then water is supplied to Durban Heights under gravity only and no pumping from Inanda Dam is undertaken;
- When Nagle or Albert Falls Dams are below full supply capacity and are unlikely to reach full supply capacity in the season then the supply of water to the Durban Heights WTP is maximised through pumping from Inanda Dam and augmented with supply, under gravity, from Nagle Dam. In this instance, all the Inanda Dam pumps, including the Shaft pumps, are operated to maximise the supply from Inanda Dam and prevent spills as far as possible; and
- Allow for possible down-time on all pumping routes in the system to account for scheduled maintenance and unplanned operational interruptions (e.g. as a result of power failures).

The option to use rainfall forecasts to try to predict dam levels and therefore optimise pumping requirements is available. The use of forecasting periods of high and low rainfall helps to refine the pumping operating rule and determine periods when pumping could be decreased so as to minimise unnecessary energy usage.

(b) Mkhomazi Water Resource Region

The current water resources of the uMngeni System are insufficient to meet the long-term water demands of the system (DWS, 2015). The DWS Reconciliation Strategy Study (DWS, 2017) indicates that a development on the uMkhomazi River, the third-largest river in KwaZulu-Natal in terms of mean annual runoff (MAR), to transfer water to the existing uMngeni System, is the most feasible option for supporting the uMngeni System.

The proposed uMkhomazi Water Project comprises the following components (DWS, 2015):

- A 251 million m³ dam at Smithfield on the uMkhomazi River;
- A 32 km tunnel between the Smithfield Dam and Baynesfield in the uMlaza Catchment;
- The option of a new 15.7 million m³ Langa Balancing Dam at Baynesfield has been excluded; this means that the 600 Mℓ/day water treatment plant will not operate when the uMkhomazi tunnels are taken out of service for maintenance and inspection work; and
- A gravity potable water pipeline to link this system to uMngeni-uThukela Water's 57' Pipeline. This scheme would have a 1:100 yield of 600 Mℓ/day and this should accommodate the increase in demand in the uMngeni system for 30 to 40 years. Once the yield of the Smithfield Dam is fully utilised then an additional dam could be constructed on the uMkhomazi River at Impendle and, with an additional tunnel at Smithfield Dam, the yield of the system would then increase by an additional 600 Mℓ/day allowing for the long term growth of the system. The uMkhomazi Water Project is described in **Section 7.5.2 (a)**.

7.3 Supply Systems

7.3.1 Description of the uMngeni System

(a) Overview of Upper uMngeni System

The Upper uMngeni System currently serves urban, peri-urban and rural settlements within the uMgungundlovu, Msunduzi, iLembe and eThekweni (Outer West) municipal areas (**Figure 7.3**). The system extends from Howick / Mpophomeni / Vulindlela in the west, to Wartburg / New Hanover / Dalton / Ozwatini in the east, to Cato Ridge / Mpumulanga in the South and to Eston / Umbumbulu in the South West.

With the recent commissioning of eThekweni Metro Municipality's Western Aqueduct, the system has now been further extended to the Ntuzuma / Inanda / KwaMashu Supply Systems. The system derives its water resource from the Upper uMngeni River, fed from Midmar Dam, with augmentation from the Mooi-uMngeni Transfer Scheme (MMTS) (**Section 7.2.3 (a)**). Water is treated at two Water Treatment Plants (WTP's), namely the Midmar WTP located in Howick and the D.V. Harris WTP located in Pietermaritzburg.

For the purpose of describing the Upper uMngeni System, it has been divided into Sub-Systems which have been further divided into links. This is illustrated in **Table 7.14**.

Table 7.14 Sub-divisions of the Upper uMngeni System.

Sub-System	Water Treatment Plant	Link
Howick-North	Midmar	<ul style="list-style-type: none"> ▪ Mill Falls Pump Station to Howick-North Reservoir
Howick-West	Midmar	<ul style="list-style-type: none"> ▪ Mill Falls Pump Station to Howick-West Reservoir ▪ Howick-West Reservoir to Groenekloof Reservoir ▪ Groenekloof Reservoir Supply Area
Midmar WTP to Umlaas Road Reservoir	Midmar	<ul style="list-style-type: none"> ▪ '251 Pipeline: Midmar WTP to D.V. Harris Off-Take ▪ '53 Pipeline: D.V. Harris WTP to Umlaas Road Reservoir ▪ '61 Pipeline: D.V. Harris WTP to World's View Reservoir ▪ '61 Pipeline: World's View Reservoir to ED4 ▪ '61 Pipeline: ED4 to Umlaas Road Reservoir ▪ Ashburton Supply ▪ Richmond Pipeline ▪ Thornville/Hopewell Supply
Umlaas Road Reservoir	Midmar & D.V. Harris	<ul style="list-style-type: none"> ▪ '57 Pipeline ▪ Eston / Umbumbulu Pipeline ▪ Lion Park / Manyavu Pipeline
uMshwathi BWSS	D.V. Harris	<ul style="list-style-type: none"> ▪ Msunduzi Supply ▪ '69 Pipeline (Claridge Reservoir to Wartburg Reservoir) ▪ Wartburg Reservoir to Bruyns Hill Reservoir ▪ Wartburg Reservoir to Dalton Reservoir ▪ Dalton Reservoir to Ozwathini Reservoir

(b) Midmar Water Treatment Plant

The Midmar WTP (**Figure 7.29, Table 7.15**), which was commissioned in 1996, draws raw water from Midmar Dam. Water from the dam is supplied under pumping via the '251 Pipeline (**Table 7.16**). The '251 raw water pipeline consists of two sections (one that has recently been constructed and

commissioned) – two gravity pipelines feed water from the dam to a raw water pump station, and two rising mains from the pump station to the WTP. The new raw water pipeline was implemented as a risk mitigation measure to ensure the sustainability of supply should any one of the mains be out of service. Four pump sets are currently installed in the raw water pump station (3 duty + 1 standby) (Table 7.17). The details for the WTP clearwells are shown in Table 7.18.



Figure 7.29 Midmar Water Treatment Plant after the upgrade.

In 2018, the Midmar WTP capacity was upgraded from 250 Mℓ/day to 395 Mℓ/day. The WTP supplies water to Howick and Mpophomeni, most of the south-western and southern suburbs of Pietermaritzburg, Greater Edendale, Vulindlela, Thornville, Hopewell, Richmond and the Umlaas Road node via the '61 and '261 Pipelines. It also serves eThekweni Municipality's Outer West area (comprising Cato Ridge, Georedale, Camperdown, Gillitts, and Hillcrest), as well as consumers on the Lion Park and Eston-Umbumbulu pipelines from the Umlaas Road node. The supply area has also now been extended to eThekweni Metropolitan Municipality's Western Aqueduct, which supplies areas as far east as Inanda, Ntuzuma and KwaMashu.

The primary source of water for the Umlaas Road Reservoir node is the Midmar WTP, although this is supported by a potential maximum of 35 Mℓ/day from the D.V. Harris WTP via the '53 Pipeline. This, not only reduces the operational risk of having a single pipeline supplying Umlaas Road, but also allows uMngeni-uThukela Water to transfer some of the demand off the '61 Pipeline system, especially during high demand periods and planned outages.

Table 7.15 Characteristics of the Midmar WTP.

WTP Name:	Midmar WTP
System:	Upper uMngeni System
Maximum Design Capacity:	395 Mℓ/day
Current Utilisation:	367.77 Mℓ/day
Raw Water Storage Capacity:	0 Mℓ
Raw Water Supply Capacity:	395 Mℓ/day @ velocity of 1.3 m/s
Pre-Oxidation Type:	Pre-chlorination
Primary Water Pre-Treatment Chemical:	Polymeric Coagulant
Total Coagulant Dosing Capacity:	35 l/hr (according to Operating Manual)
Rapid Mixing Method:	Static Mixer
Clarifier Type:	Pulsator Clarifier
Number of Clarifiers:	5
Total Area of all Clarifiers:	3380 m ²
Total Capacity of Clarifiers:	500 Mℓ/day
Filter Type:	Constant Rate Rapid Gravity Filters
Number of Filters:	18
Filter Floor Type	Plate Design
Total Filtration Area of all Filters	2520 m ²
Total Filtration Design Capacity of all Filters:	395 Mℓ/day
Total Capacity of Backwash Water Tanks:	2100 m ³
Total Capacity of Sludge Treatment Plant:	360 - 900 m ³ /hr (rating on thin sludge pumps)
Capacity of Used Washwater System:	10 Mℓ/day
Primary Post Disinfection Type:	Chloramination
Disinfection Dosing Capacity:	15 kg/hr
Disinfectant Storage Capacity:	8 x 1 ton full chlorine cylinders + 20 ton of ammonia delivered
Total Treated Water Storage Capacity:	7 Mℓ

Table 7.16 Pipeline details: '251 Pipeline.

System	Pipeline Name	From	To	Length (km)	Nominal Diameter (mm)	Material	Capacity * (Mℓ/day)	Age (years)
Upper uMngeni	'251 Pipeline	Midmar Raw Water Pump Station	Midmar WTP	3.30	1600	Steel	347.91	36
Upper uMngeni	'251 Pipeline	Midmar Dam	Midmar Raw Water Pump Station	0.40	1600	Steel	347.91	67
Upper uMngeni	'251 Pipeline	Midmar Dam	Midmar Raw Water Pump Station	0.40	1600	Steel	347.91	267
Upper uMngeni	'251 Pipeline	Midmar Raw Water Pump Station	Midmar WTP	3.30	1600	Steel	347.91	27
Upper uMngeni	'251 Pipeline	Midmar WTP	Midmar Reservoir	6.50	1600	Steel	347.91	27
Upper uMngeni	'251 Pipeline	Midmar Reservoir	D.V. Harris WTP	8.06	1600	Steel	347.91	27

* Based on a velocity of 2 m/s

Table 7.17 Pump station details: Midmar Raw Water Pump Station.

System	Pump Station Name	Pump Set	Pump Status		Pump Description	Supply From	Supply To	Static Head (m)	Duty Head (m)	Duty Capacity (Mℓ/day)
			Duty	Standby						
Upper uMngeni	Midmar Raw Water	Pump No 1	✓		Sulzer Bros:SM 602-570	Midmar Dam	Midmar WTP	15	35	131
Upper uMngeni	Midmar Raw Water	Pump No 2	✓		Sulzer Bros:SM 602-570	Midmar Dam	Midmar WTP	15	35	131
Upper uMngeni	Midmar Raw Water	Pump No 3	✓		Sulzer Bros:SM 602-570	Midmar Dam	Midmar WTP	15	35	131
Upper uMngeni	Midmar Raw Water	Pump No 4		✓	Sulzer Bros:SM 602-570	Midmar Dam	Midmar WTP	15	35	131

Table 7.18 Clearwell details: Midmar WTP.

System	Reservoir Site	Reservoir Name	Capacity (Mℓ)	Reservoir Function	TWL (mASL)	FL (mASL)
Upper uMngeni	Midmar WTP	Midmar Clearwells	7	Bulk	979.00	974.0*

*Assumed value

(c) Howick-North Sub-System

The Howick-North Sub-System is shown in **Figure 7.30**.

(i) Mill Falls Pump Station to Howick-North Reservoir Complex

The Howick-North Reservoir Complex consists of four reservoirs having varying top water levels (**Table 7.19**). Water treated at Midmar WTP is pumped from the Mill Falls Pump Station (**Table 7.20**) through a 400 mm diameter steel pipeline (**Table 7.21**) to Reservoir 3 (4.5 Mℓ/day) and via a 300mm diameter pipeline to the new Reservoir 4 (6.5 Mℓ/day) and Reservoir 1 (1.2 Mℓ/day). Howick Reservoir 2 (0.9 Mℓ/day) has been decommissioned. Howick Reservoir 1 is not currently operational, but future use is expected when a request is received from uMgungundlovu District Municipality to supply water to the high lying areas. The existing 300 mm diameter pipeline from Reservoir 1 to Reservoir 3 has been abandoned.

The old supply pipeline (Greendale pipeline) is no longer in use, but has been left in place as an emergency rising main. Alternatively, it could be used in future, as a back-feed reticulation line by uMgungundlovu District Municipality (**Table 7.21**).

(d) Howick-West Sub-System

The Howick-West Sub-System is shown in **Figure 7.31**.

(i) Mill Falls Pump Station to Howick-West Reservoir

Water from the Mill Falls Pump Station (**Table 7.20**) is also pumped to the Howick-West Reservoir Complex (**Table 7.23**) through a 700 mm diameter steel pipeline (**Table 7.24**). The original 375 mm diameter asbestos cement pipe from Midmar WTP to Howick-West Reservoir is now utilised as a back-feed pipeline (**Table 7.24**). This back-feed pipeline supplies potable water to Merrivale, a low-cost housing scheme at Howick West, online consumers and the Midmar WTP.

(ii) Howick-West Reservoir to Groenekloof Reservoir

The Howick-West Reservoir Complex consists of two 8.25 Mℓ reservoirs and one 16 Mℓ reservoir (**Table 7.23**). These reservoirs provide storage for the residential communities in Howick-West and Mpophomeni and serves as balancing reservoirs within the bulk supply system. The additional 16Mℓ Reservoir has been commissioned to ensure adequate storage to meet the current and projected demand of the supply area.

Water is pumped from the Howick-West Pump Station (**Table 7.22**), situated at the Howick-West Reservoir Complex, to the Groenekloof Reservoir through a 600 mm diameter pipeline ('67 Pipeline) (**Table 7.24**).

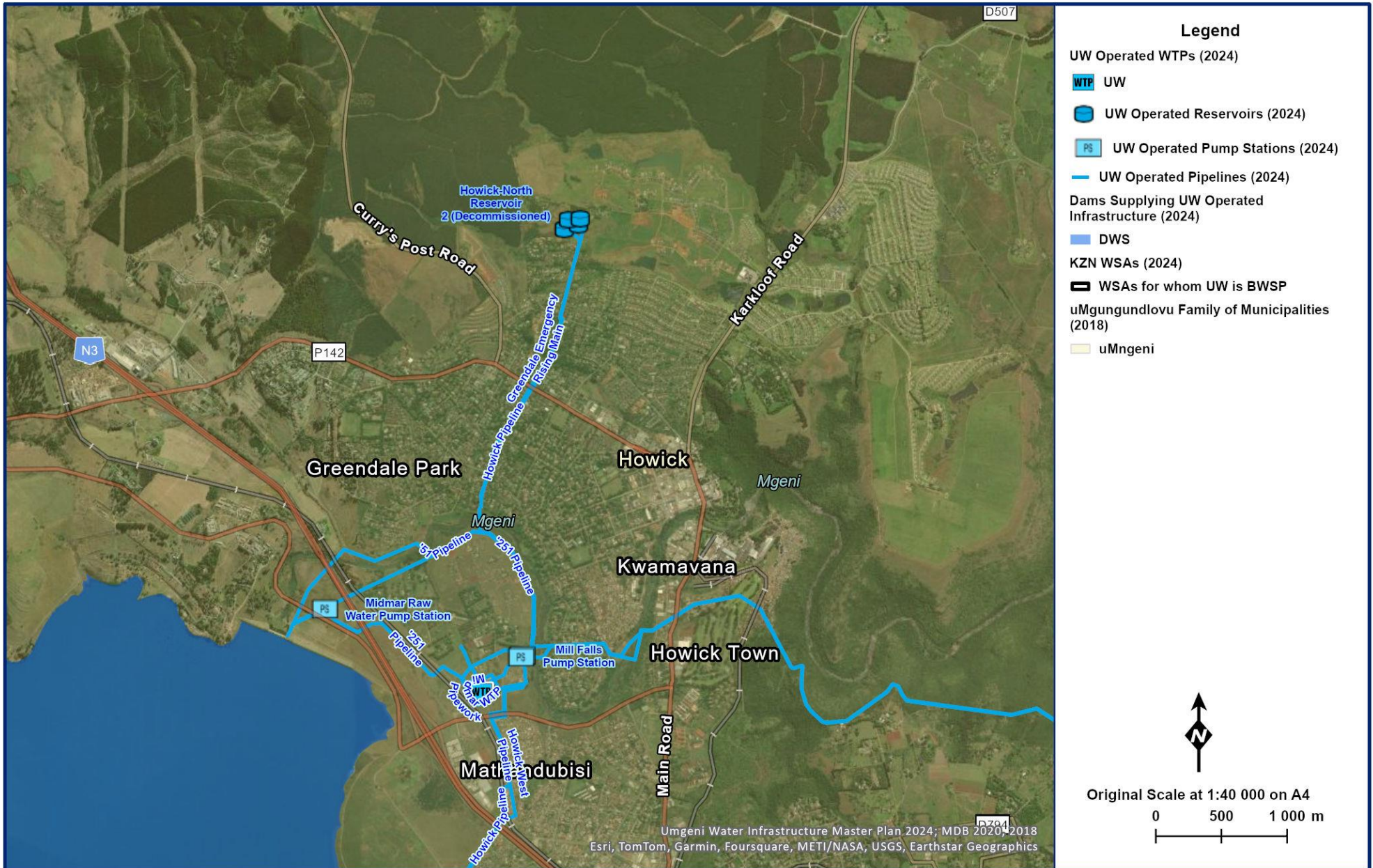

Figure 7.30 General Layout of the Howick-North Sub-System.

Table 7.19 Reservoir details: Howick-North Reservoir Complex.

System	Reservoir Site	Reservoir Name	Capacity (Mℓ)	Reservoir Function	TWL (mASL)	FL (mASL)
Upper uMngeni	Howick-North	Howick-North Reservoir 1 (Not currently in service)	1.2	Terminal	1113.98	1111.30
Upper uMngeni	Howick-North	Howick-North Reservoir 2 (Decommissioned)	0.9	Terminal	1104.81	1102.06
Upper uMngeni	Howick-North	Howick-North Reservoir 3	4.5	Terminal	1105.66	1098.04
Upper uMngeni	Howick-North	Howick-North Reservoir 4	6.5	Terminal	1105.66	1098.04

Table 7.20 Pump details: Howick-North Sub-System.

System	Pump Station Name	Pump Set	Pump Status		Pump Description	Supply From	Supply To	Static Head (m)	Duty Head (m)	Duty Capacity (Mℓ/day)
			Duty	Standby						
Upper uMngeni	Mill Falls	Howick Pump No 1		✓	KSB:WKLn 125-3	Midmar WTP	Howick Reservoir	75	99.0	4.5
Upper uMngeni	Mill Falls	Howick Pump No 2		✓	KSB:WKLn 125-3	Midmar WTP	Howick Reservoir	75	99.0	4.5
Upper uMngeni	Mill Falls	Howick Pump No 3	✓		KSB:ETA 150-50	Midmar WTP	Howick Reservoir	75	77.4	6.9

Table 7.21 Pipeline details: Howick-North Sub-System.

System	Pipeline Name	From	To	Length (km)	Nominal Diameter (mm)	Material	Capacity * (Mℓ/day)	Age (years)
Upper uMngeni	Howick Pipeline	Mill Falls Pump Station	Howick Reservoir	2.5	400	Steel	16.30	27
Upper uMngeni	Howick Pipeline	Mill Falls Pump Station	Howick Reservoir	2.5	300	AC	9.20	52

* Based on a velocity of 1.5 m/s

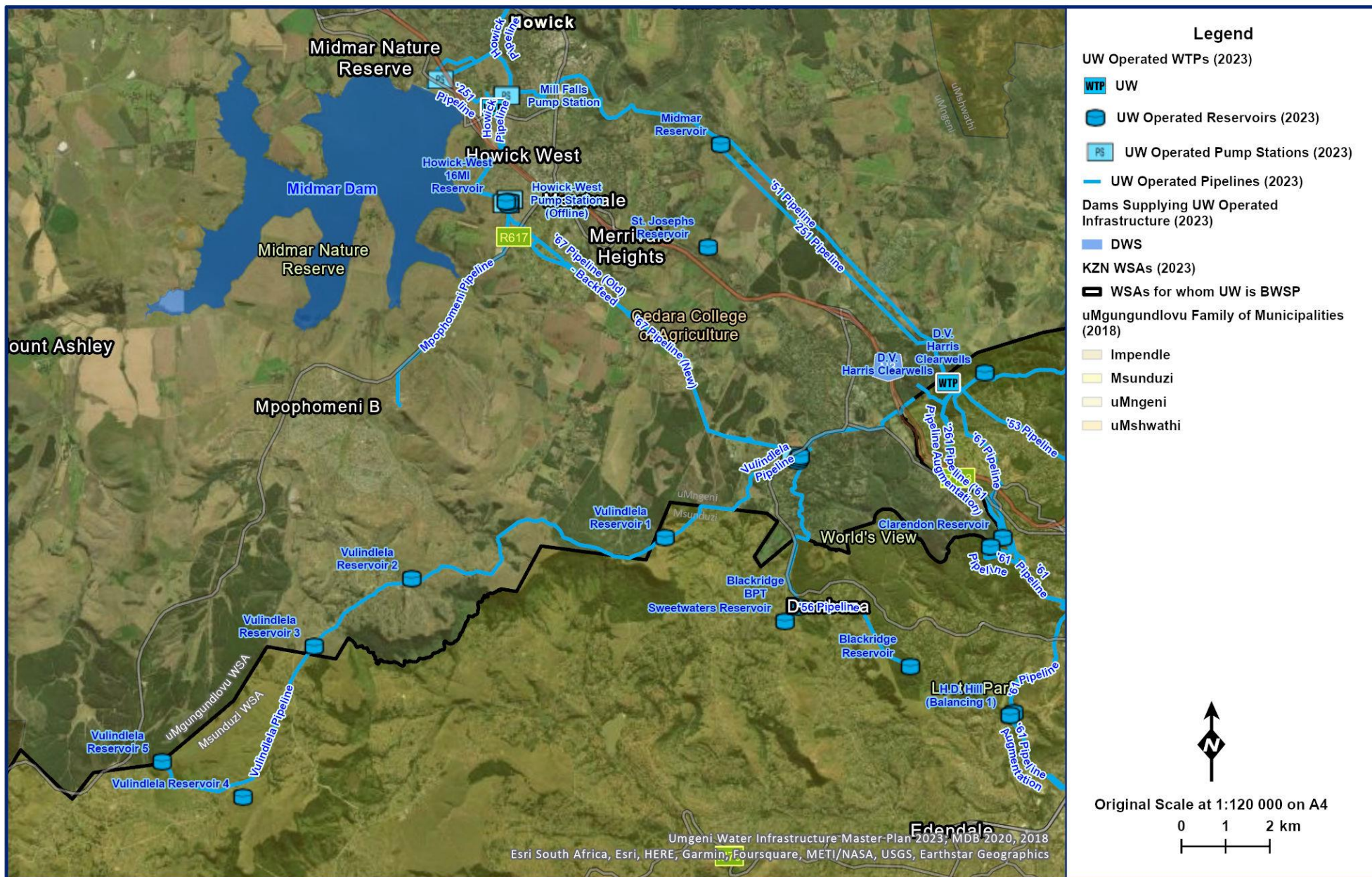

Figure 7.31 General Layout of the Howick-West Sub-System.

Table 7.22 Pump details: Howick-West Sub-System.

System	Pump Station Name	Pump Set	Pump Status		Pump Description	Supply From	Supply To	Static Head (m)	Duty Head (m)	Duty Capacity (Mℓ/day)
			Duty	Standby						
Upper uMngeni	Mill Falls	Howick-West Pump No 1	✓		KSB	Midmar WTP	Howick-West	86	107	25.1
Upper uMngeni	Mill Falls	Howick-West Pump No 2		✓	KSB	Midmar WTP	Howick-West	86	107	25.1
Upper uMngeni	Howick-West	Mpophomeni Pump No 1	✓		KSB:WKLn 150/3	Howick-West Reservoir	Mpophomeni Reservoir	56	120	6.1
Upper uMngeni	Howick-West	Mpophomeni Pump No 2		✓	KSB:WKLn 150/3	Howick-West Reservoir	Mpophomeni Reservoir	56	120	6.1
Upper uMngeni	Howick-West	Groenekloof No 1	✓		KSB:ROL 250-620	Howick-West Reservoir	Groenekloof Reservoir	87	130	18.0
Upper uMngeni	Howick-West	Groenekloof No 2		✓	KSB:ROL 250-620	Howick-West Reservoir	Groenekloof Reservoir	87	130	18.0
Upper uMngeni	Groenekloof	Low Lift Pump No 1	✓		Amalgamated Power Eng:DSM 150-46	Groenekloof Reservoir	Vulindlela Reservoir 1	103	120	7.1
Upper uMngeni	Groenekloof	Low Lift Pump No 2	✓		Amalgamated Power Eng:Omega 150-605	Groenekloof Reservoir	Vulindlela Reservoir 1	103	120	7.1
Upper uMngeni	Groenekloof	Low Lift Pump No 3		✓	Amalgamated Power Eng:DSM 150-46	Groenekloof Reservoir	Vulindlela Reservoir 1	103	120	7.1
Upper uMngeni	Groenekloof	High Lift Pump No 1	✓		Amalgamated Power Eng:RKB Size 200-37	Groenekloof Reservoir	Vulindlela Reservoirs 2 - 5	226	351	11
Upper uMngeni	Groenekloof	High Lift Pump No 2	✓		Amalgamated Power Eng:RKB Size 200-37	Groenekloof Reservoir	Vulindlela Reservoirs 2 - 5	226	351	11
Upper uMngeni	Groenekloof	High Lift Pump No 3		✓	Amalgamated Power Eng:WL 200/7	Groenekloof Reservoir	Vulindlela Reservoirs 2 - 5	226	351	11

Table 7.23 Reservoir details: Howick-West Sub-System.

System	Reservoir Site	Reservoir Name	Capacity (Mℓ)	Reservoir Function	TWL (mASL)	FL (mASL)
Upper uMngeni	Howick-West	Howick-West Reservoir 1	8.3	Distribution	1125.1	1118.1
Upper uMngeni	Howick-West	Howick-West Reservoir 2	8.3	Distribution	1125.1	1118.1
Upper uMngeni	Howick-West	Howick-West Reservoir 3	16	Distribution	1125.1	1118.1
Upper uMngeni	Blackridge	Blackridge Reservoir	2.2	Terminal	1006.0	1004.0*
Upper uMngeni	Sweetwaters**	Sweetwaters Reservoir	0.5	Terminal	1107.0	1103.0
Upper uMngeni	Vulindlela	Vulindlela Reservoir 1	10.0	Distribution	1313.9	1307.9
Upper uMngeni	Vulindlela	Vulindlela Reservoir 2	10.0	Distribution	1410.0	1404.0
Upper uMngeni	Vulindlela	Vulindlela Reservoir 3	0.6	Distribution	1403.9	1399.7
Upper uMngeni	Vulindlela	Vulindlela Reservoir 4	0.2	Distribution	1425.8	1422.5
Upper uMngeni	Vulindlela	Vulindlela Reservoir 5	9.2	Distribution	1494.0	1488.0
Upper uMngeni	Hilton	Groenekloof Reservoir 1	2.3	Distribution	1210.6	1205.1
Upper uMngeni	Hilton	Groenekloof Reservoir 2	5.0	Distribution	1210.6	1205.4
Upper uMngeni	Hilton	Groenekloof Reservoir 3	10.0	Distribution	1210.6	1205.1

* Estimated

** Reservoir owned and operated by Msunduzi Municipality

Table 7.24 Pipeline details: Howick-West Sub-System.

System	Pipeline Name	From	To	Length (km)	Nominal Diameter (mm)	Material	Capacity (Mℓ/day)	Age (years)
Upper uMngeni	Howick West Pipeline	Mill Falls Pump Station	Howick-West Reservoir	3.30	700	Steel	66.6	44
Upper uMngeni	Howick West Pipeline	Howick-West Reservoir	Midmar WTP (Backfeed)	3.40	375	AC	19.0	44
Upper uMngeni	Mpophomeni Pipeline	Howick-West Pump Station	Mpophomeni Reservoir	5.80	250	AC	8.5	44
Upper uMngeni	'67 Pipeline (New)	Howick-West Pump Station	Groenekloof Reservoir	9.80	600	Steel	49.0	26
Upper uMngeni	'67 Pipeline (Old) - Backfeed	Groenekloof Reservoir	Howick-West Reservoir	9.80	300	AC	12.2	41
Upper uMngeni	Vulindlela Pipeline	Groenekloof Pump Station – Low-Lift Pump Station	Vulindlela Reservoir 1	4.25	400	Steel	21.7	27
Upper uMngeni	Vulindlela Pipeline	Groenekloof Pump Station – High-Lift Pump Station	Vulindlela Reservoir 5	27.90	500	Steel	34.0	27
Upper uMngeni	'56 Pipeline	Groenekloof Reservoir	Blackridge BPT	7.30	250	uPVC	8.5	39
Upper uMngeni	Sweetwaters Pipeline	'56 Pipeline (Upstream of Blackridge BPT)	Sweetwaters Reservoir	4.40	250	uPVC	8.5	39
Upper uMngeni	'56 Pipeline	Blackridge BPT	Blackridge Reservoir	3.30	250	uPVC	8.5	39

(iii) Groenekloof Reservoir Supply Area

The Groenekloof Reservoir Complex (**Table 7.23**) consists of three reservoirs with a combined capacity of 17.27 Mℓ.

The Groenekloof Reservoir Complex has a 300 mm diameter back-feed pipeline (old '67 Pipeline) (**Table 7.24**) that supplies consumers in Hilton and Cedara. This Complex also supplies the Vulindlela reservoirs and Blackridge Reservoir.

A 600 mm diameter pipeline from Groenekloof Reservoir feeds the Groenekloof Pump Station (**Table 7.22**). The pump station has high-lift pumps that supply Vulindlela Reservoirs 2 - 5 and low-lift pumps that supply Vulindlela Reservoir 1 (**Table 7.23**). The Vulindlela reservoirs supply the Vulindlela area through a network consisting of reservoirs and reticulation pipelines.

Groenekloof Reservoir also supplies Blackridge Reservoir (**Table 7.23**), through a 250 mm diameter pipeline ('56 Pipeline) (**Table 7.24**). There is a 160 mm diameter off-take along this pipeline supplying Sweetwaters Reservoir (**Table 7.24** and **Table 7.23**).

(e) Midmar WTP to Umlaas Road Reservoir Sub-System

The Midmar WTP to Umlaas Road Reservoir Sub-System is shown in **Figure 7.32**.

(i) '251 Pipeline (Midmar WTP to D.V. Harris Off-Take)

Downstream of Midmar WTP, the '251 Pipeline (**Table 7.27**) conveys potable water via the Midmar Reservoir (**Table 7.25**) to the inlet of the Midmar Tunnel (**Table 7.26**). Downstream of the tunnel, the '251 Pipeline resumes and delivers water into the '61 Pipeline (**Table 7.27**) at Ferncliffe near the D.V. Harris WTP. The '251 Pipeline ends at an off-take to the D.V. Harris WTP, and this allows for an emergency supply of potable water to the D.V. Harris WTP.

While the capacity of this pipeline is 347 Mℓ/day, the flow is restricted to 330 Mℓ/day due to the capacity of the Midmar Tunnel.

The Midmar Reservoir is situated on the '251 Pipeline, just upstream of the inlet portal of the Midmar Tunnel. As there is limited clear water storage at Midmar WTP itself, Midmar Reservoir serves as the off-site potable water storage facility for the Midmar WTP. It also serves as a break-pressure tank for the '251 Pipeline prior to its entry into the tunnel. The reservoir was constructed in 1996 when the supply to the '61 Pipeline was transferred across from the D.V. Harris WTP to the then newly constructed Midmar WTP.

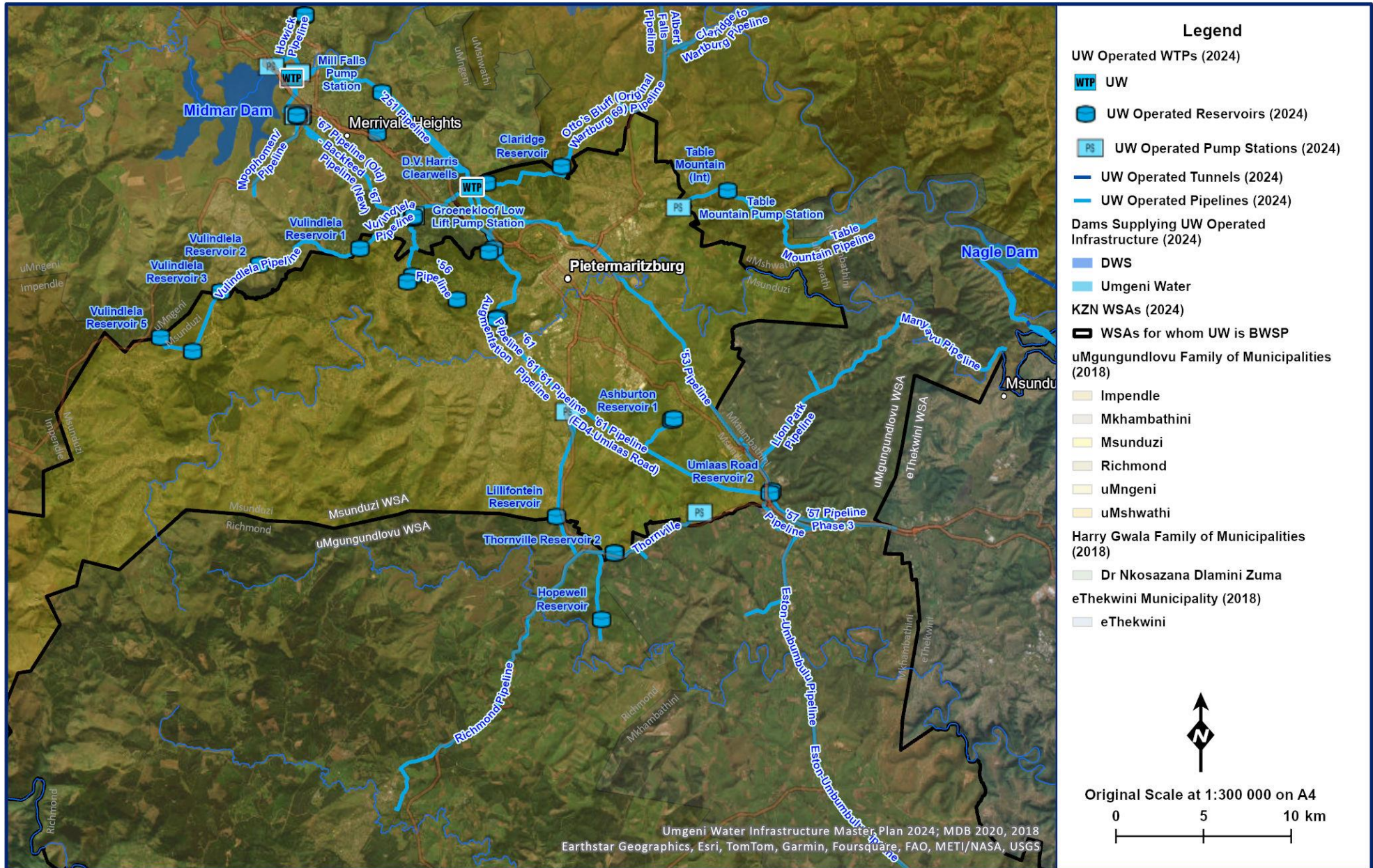

Figure 7.32 General Layout of the Midmar WTP to Umlaas Road Reservoir Sub-System.

Table 7.25 Reservoir details: Midmar WTP to Umlaas Road Reservoir Sub-System.

System	Reservoir Site	Reservoir Name	Capacity (Mℓ)	Reservoir Function	TWL (mASL)	FL (mASL)
Upper uMngeni	Cedara	Midmar Reservoir	45.0	Bulk	1014.0	1001.0
Upper uMngeni	Clarendon	Clarendon Reservoir	25.0	Terminal	970.0	965.0*
Upper uMngeni	World's View	World's View Reservoir	80.0	Bulk	962.0	954.8
Upper uMngeni	Thornville	Thornville Reservoir	2.0	Terminal	954.9	949.7
Upper uMngeni	Hopewell	Hopewell Reservoir	0.5	Terminal	872.4	864.4
Upper uMngeni	Lillifontein	Lillifontein Reservoir	5	Bulk	1022.8	1014.8
Upper uMngeni	Ashburton	Ashburton High-Level Reservoir	0.5	Terminal	775.3	773.3
Upper uMngeni	Fernclyffe	D.V. Harris Clearwells	4.1	Bulk	978.9	977.1
Upper uMngeni	H.D. Hill	H.D. Hill (Balancing 1)	22.4	Distribution	869.3	862.4
Upper uMngeni	H.D. Hill	H.D. Hill (Balancing 2)	22.3	Distribution	869.3	862.4
Upper uMngeni	Cedara	St. Josephs Reservoir	0.1	Terminal	1074.2	1072.2

* Estimated

Table 7.26 Tunnel details: Upper uMngeni System.

System	Name	Total Length (m)	Height (m)	Radius (m)	Lining	Year Constructed	Transition	Semi-Arc
Upper uMngeni	Midmar Tunnel	6337	1800	1600	Concrete Lined	1996		
Upper uMngeni	Hilton Tunnel	6215	1800	1600	Concrete Lined	1959		

Table 7.27 Pipeline details: Midmar WTP to Umlaas Road Reservoir Sub-System.

System	Pipeline Name	From	To	Length (km)	Nominal Diameter (mm)	Material	Capacity * (Mℓ/day)	Age (years)
Upper uMngeni	'251 Pipeline	Midmar WTP	Midmar Reservoir	6.50	1600	Steel	347.9	27
Upper uMngeni	'251 Pipeline	Midmar Tunnel Outlet	D.V. Harris WTP	8.06	1600	Steel	347.9	27
Upper uMngeni	'61 Pipeline	D.V. Harris WTP	World's View Reservoir	6.20	1000, 900 and 800	Steel	330.0	44
Upper uMngeni	'60 Pipeline	D.V. Harris WTP	World's View Reservoir	6.20	900 and 1200	Steel	330.0	10
Upper uMngeni	'61 Pipeline	World's View Reservoir	H.D. Hill	29.60	1000 and 1000	Steel	271.7	44
Upper uMngeni	'61 Pipeline	H.D. Hill	ED2 (Duplication)	8.90	1000 and 1000	Steel	271.7	21
Upper uMngeni	'61 Pipeline	ED2 (old)	Richmond P/L off-take	4.0	800	Steel	87.0	44
Upper uMngeni	'61 Pipeline	ED2 (new)	Richmond P/L off-take (Augmentation)	4	1300	Steel	229.5	12
Upper uMngeni	'61 Pipeline	Richmond P/L off-take	Umlaas Road	13.00	800	Steel	87.0	44
Upper uMngeni	'61 Pipeline	ED4	Umlaas Road	13.00	1100	Steel	133	9
Upper uMngeni	Ambleton Pipeline	Off-Take from '61 Pipeline	Ambleton Reservoir	2.00	160	Steel	3.5	31
Upper uMngeni	Ashburton Pipeline	Off-Take from '61 Pipeline	Ashburton Reservoir	2.70	160	Galvanised Mild Steel	3.5	31
Upper uMngeni	'Richmond Pipeline	Lillifontein Reservoir	Thornville Reservoir 1	4.9	350	Steel	6.2	9
Upper uMngeni	'Richmond Pipeline	Lillifontein Reservoir	Richmond Reservoir	22.6	450	Steel	7.6	9
Upper uMngeni	Hopewell Pipeline	Thornville Reservoir	Hopewell Reservoir	4.91	200	mPVC	5.4	37
Upper uMngeni	Thornville	Thornville Reservoir	De-commissioned Pump Station	7.90	160/200	Steel/AC	8.9	37
Upper uMngeni	Baynesfield	Thornville Reservoir	Baynesfield	4.95	200	AC	5.4	37
Upper uMngeni	'53 Pipeline	D.V. Harris WTP	Umlaas Road	26.60	762	Pre-Stressed Concrete	35.0	65

* Capacity based on velocity of 2 m/s

(ii) '61 Pipeline: D.V. Harris to World's View Reservoir

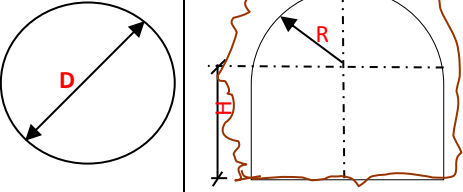
The configuration of the pipelines between D.V. Harris WTP and World's View Reservoir is shown in **Figure 7.33**. It shows the current operating arrangement which is as follows:

- Clarendon Reservoir is fed from D V Harris WTP through the '60 pipeline; and
- World's View Reservoir is fed from Midmar WTP through a 1000 mm diameter and the newer 900/1200 mm diameter pipeline.

When the demand downstream of World's View Reservoir reaches 245 Mℓ/day, the 800 mm diameter '60 pipeline will have to be utilised to augment the supply from Midmar WTP into World's View Reservoir. This will mean that Clarendon Reservoir will then have to be fed from Midmar WTP. Clarendon Reservoir supplies the Msunduzi Municipalities Symons and Hathorns Reservoirs, and these feed the majority of Pietermaritzburg central town and surrounds.

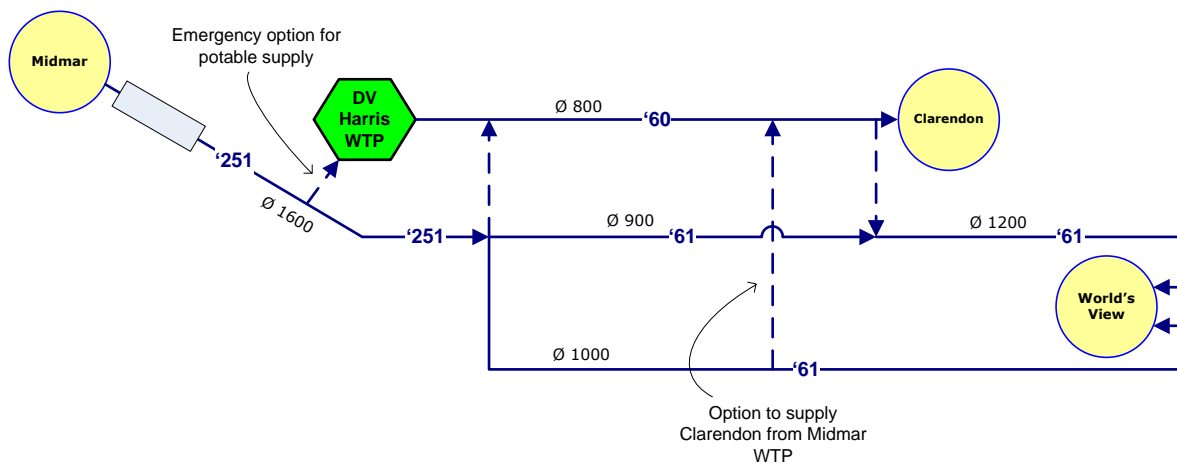

Figure 7.33 Pipeline configuration between D.V. Harris WTP and World's View Reservoir.

(iii) '61 Pipeline: World's View Reservoir to ED2

Dual 1 000 mm diameter gravity pipelines provide water from World's View Reservoir to the ED2 offtake (**Table 7.27**) which is a sales point to The Msunduzi Municipality's Edendale area. One of these pipelines is a dedicated supply to the western portions of The Msunduzi Municipality, consisting of Edendale (ED1 and ED2 (ED3-closed)). The two pipelines connect via a cross connection at ED2.

The H.D. Hill Balancing Reservoir supplies Bisley Reservoir (mainly Pietermaritzburg's western suburbs); with supply zones from Masons, Masons Industrial, Oribi and Bisley.

(iv) '61 Pipeline: ED2 to Umlaas Road Reservoir

Two pipelines, an 800 mm and 1 300 mm diameter pipeline from ED2 to the Richmond Offtake and an 800 mm and 1 100 mm pipeline from ED4 to Umlaas Road, supply water from ED2 to Umlaas Road Reservoir. There are off-takes on-route for Edendale (ED4), Richmond, Foxhill Emergency, Ashburton Reservoir and the now decommissioned Thornville/Hopewell Supply (**Table 7.25** and **Table 7.27**). The Foxhill Emergency supply zone demands have increased significantly.

(v) Ashburton Supply

An off-take from the '61 Pipeline supplies the Ashburton High-Level Reservoir (**Table 7.25**) through a 160mm diameter galvanised mild steel pipeline (**Table 7.27**). The reservoir feeds directly into the Msunduzi Municipality's Ashburton Lower Reservoir. The supply zone off this reservoir is the Ashburton and Lynnfield Park areas.

(vi) Richmond/Thornville/Hopewell Supply

A 600 mm diameter off-take from the '61 Pipeline supplies the Lillifontein Reservoir via the Richmond Pump Station. The Thornville Reservoir (**Table 7.25**) is supplied under gravity through a 350 mm diameter pipeline (**Table 7.28**). The reservoir serves the Thornville and Baynesfield area. An off-take on the pipeline to Baynesfield supplies water to the Hopewell Reservoir (**Table 7.25**) which serves as reticulation storage for the Hopewell community.

The rising main from the '61 Pipeline to Thornville was used as a back-feed gravity main, after the commissioning of the Richmond Pipeline, to supply users along that line (i.e. supply from the Thornville Reservoir to the Thornville Pump Station). In 2015 it was changed to the old system of pumping from Thornville pumpstation to supply Thornville, Hopewell and Baynesfield areas. The change was necessitated as a result of increased water demand along the Richmond Pipeline through illegal connections from the Shenstone and Slangspruit areas. The 16 Mℓ Lillifontein Reservoir currently supplies the Thornville Reservoir, which supplies the Thornville and Hopewell supply zones.

(vii) 53 Pipeline: D. V. Harris WTP to Umlaas Road Reservoir

The '53 Pipeline is a pre-stressed concrete pipeline that was commissioned in 1968 (**Table 7.27**). It was initially constructed to supply raw water from Midmar Dam to the Umlaas Road WTP. The pipeline was decommissioned in 2002 and the Umlaas Road Reservoir then only received potable water from the Midmar WTP via the '61 Pipeline. The '53 Pipeline was re-commissioned in 2006 as a potable pipeline from the D.V. Harris WTP to augment the supply to the Umlaas Road Reservoirs (9 Mℓ and 45 Mℓ).

Table 7.28 Pump details: Thornville/Hopewell Supply.

System	Pump Station Name	Pump Set	Pump Status		Pump Description	Supply From	Supply To	Static Head (m)	Duty Head (m)	Duty Capacity (Mℓ/day)
			Duty	Standby						
Upper uMngeni	Thornville	Thornville Pump No 1	✓		KSB:WKLn 65/4Na	'61 Pipeline	Thornville Reservoir	100.0	112.0	1.5
Upper uMngeni	Thornville	Thornville Pump No 2	✓		KSB:WKLn 65/4Na	'61 Pipeline	Thornville Reservoir	100.0	112.0	1.5
Upper uMngeni	Thornville	Thornville Pump No 3	✓		KSB:WKLn 65/4 Na	'61 Pipeline	Thornville Reservoir	100.0	112.0	1.5
Upper uMngeni	Richmond	Richmond Pump No 1	✓		KSB Omega 300-860A	'61 Pipeline	Richmond Reservoir	50-140	65-165	*23-44
Upper uMngeni	Richmond	Richmond Pump No 2	✓		KSB Omega 300-860A	'61 Pipeline	Richmond Reservoir	50-140	65-165	*23-44

* Initial to ultimate capacity

(f) Umlaas Road Reservoir Sub-System

The Umlaas Road Reservoir Sub-System is shown in **Figure 7.34**. The Umlaas Road Reservoir Complex consists of a 9 Mℓ reservoir and a 45 Mℓ reservoir (**Table 7.29**), which are interlinked. The reservoir complex has two off-takes. The '57 Pipeline (**Table 7.30**) supplies potable water to the Eston, Mkhambathini and Umbumbulu supply zones as well as the Lion Park Pipeline (**Table 7.30**) and Manyavu supply zones. The Lion Park Pipeline is currently fed directly from the '61 Pipeline to ensure adequate pressure along the newly commissioned pipeline.

(i) '57 Pipeline

The '57, '157 and '257 Pipelines (800, 1000 and 1600 mm diameter respectively) run from Umlaas Road Reservoir to Point M, the sales point to eThekweni Municipality (**Table 7.30**).

(ii) Eston/Umbumbulu Pipeline

Downstream of Umlaas Road Reservoir, Eston/Umbumbulu Pipeline draws water from the 1000 mm diameter '57 Pipeline. It feeds eThekweni Municipality's Umbumbulu Reservoir. En route, there is an off-take to the Eston Reservoirs (**Table 7.29**). Further off-takes from this pipeline feed into the Greater Eston Bulk Water Supply Scheme and the Mid Illovu/Ukhalo system.

(iii) Lion Park / Manyavu Pipeline/Mkhambathini

There are off-takes along the route of the 800 mm diameter '57 Pipeline for Mkhambathini Municipality (**Table 7.30**). The supply to eThekweni Municipality has been decommissioned. A 150 mm diameter AC pipeline and a newly constructed 350 mm diameter steel pipeline, off-take from the '61 Pipeline, supplies individual consumers along the Lion Park Road. This pipeline was extended in 2011 to feed the rural area of Manyavu (**Table 7.30**).

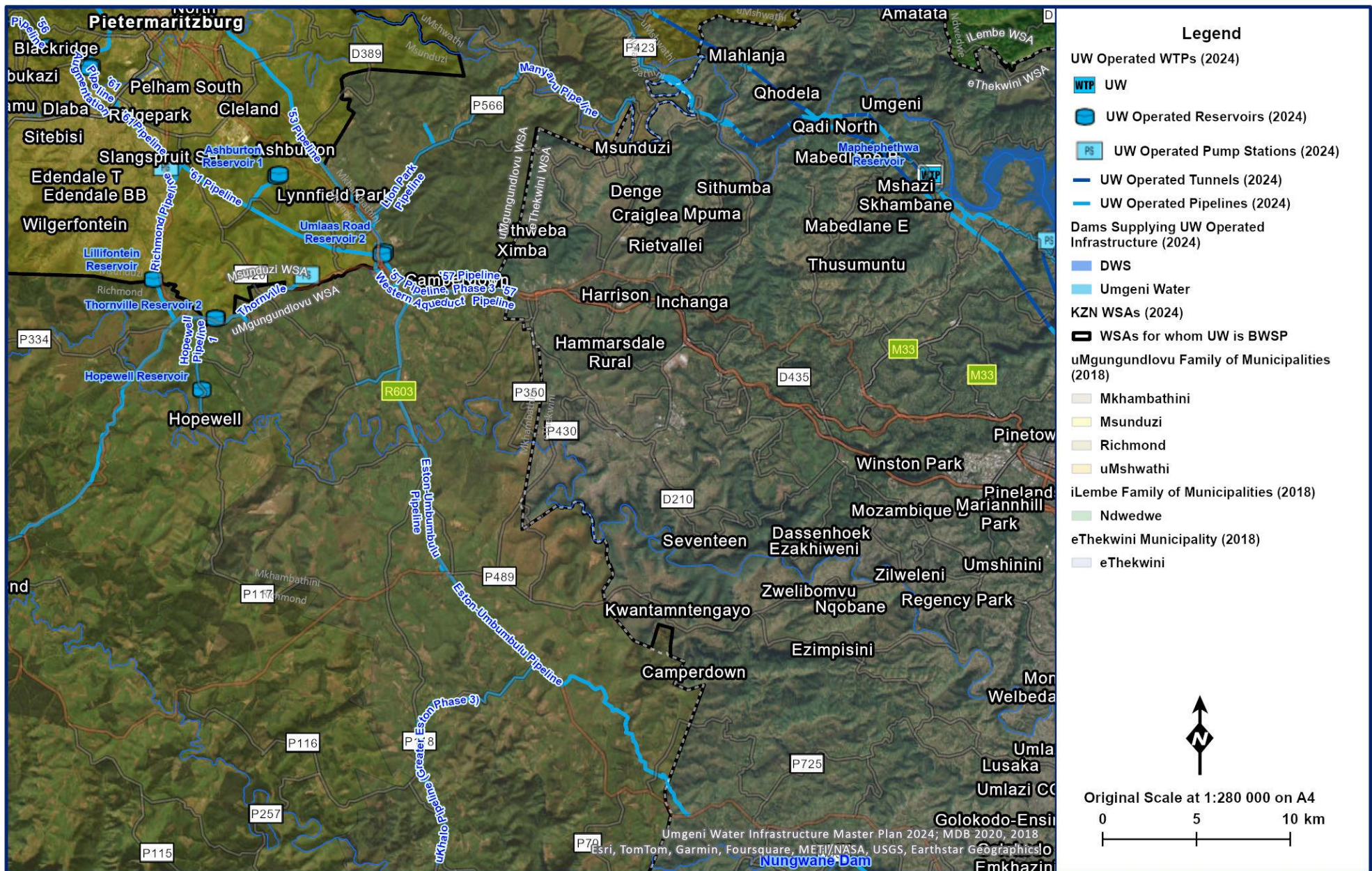

Figure 7.34 General Layout of the Umlaas Road Reservoir Sub-System.

Table 7.29 Reservoir details: Umlaas Road Reservoir Sub-System.

System	Reservoir Site	Reservoir Name	Capacity (Mℓ)	Reservoir Function	TWL (mASL)	FL (mASL)
Upper uMngeni	Umlaas Road Node	Umlaas Road Reservoir 1	9.10	Distribution	844.0	837.9
Upper uMngeni	Umlaas Road Node	Umlaas Road Reservoir 2	45.00	Distribution	844.0	836.8
Upper uMngeni	Eston Reservoir 1	Eston Reservoir 1	2.50	Terminal	791.0	786.7
Upper uMngeni	Eston Reservoir 2	Eston Reservoir 2	2.50	Terminal	791.0	786.7

Table 7.30 Pipeline details: Umlaas Road Reservoir Sub-System.

System	Pipeline Name	From	To	Length (km)	Nominal Diameter (mm)	Material	Capacity * (Mℓ/day)	Age (years)
Upper uMngeni	'57 Pipeline	Umlaas Road	Cato Ridge Bifurcation	8.60	800	Steel	87.08	51
Upper uMngeni	'257 Pipeline	Umlaas Road (Phase 3)	Cato Ridge Bifurcation	8.50	1000	Steel	135.90	28
Upper uMngeni	'357 Pipeline	Umlaas Road	Point M	8.10	1600	Steel	347.00	14
Upper uMngeni	Eston-Umbumbulu Pipeline	'57 Pipeline (Phase 3)	Eston Reservoir	16.10	600	Steel	48.93	27
Upper uMngeni	Eston-Umbumbulu Pipeline	Eston Reservoir	Umbumbulu	13.10	450	Steel	27.52	19
Upper uMngeni	Lion Park Pipeline	Umlaas Road Reservoir	Lion Park	8.60	160	Steel	3.48	50
Upper uMngeni	Lion Park Pipeline	Umlaas Road Reservoir	Lion Park	8.60	350	Steel	16.6	6
Upper uMngeni	Lion Park Pipeline	Lion Park	Consumers along the '53 Pipeline	4.60	90	HDPE	1.10	20
Upper uMngeni	Manyavu Pipeline	Lion Park	Manyavu	1.00 2.00 13.00	250 160 150	uPVC uPVC Klambon	8.50 3.50 3.10	13 13 13

* Capacity based on velocity of 2 m/s

(g) D.V. Harris Water Treatment Plant

Raw water from Midmar Dam is conveyed under gravity to the D.V. Harris WTP (**Figure 7.35**, **Table 7.31**) via the 1500 mm diameter '51 Pipeline (**Table 7.33**). On route, the raw water passes through a raw water tunnel at Hilton (**Table 7.26**).

The WTP has a design capacity of 110 Mℓ/day, but Process Services and Operations have installed Activated Carbon filters to increase the capacity to 125 Mℓ/day. There is no need to expand the plant because it is able to accommodate the maximum raw water available from Midmar Dam. The yield at a 99% assurance of supply at Midmar Dam, with MMTS 1 and MMTS 2, is 476 Mℓ/day. Midmar WTP will treat 376 Mℓ/day and the balance of 100 Mℓ/day will be treated at D.V. Harris WTP.



Figure 7.35 D.V. Harris Water Treatment Plant.

There is the option for a potable water supply from Midmar WTP through the '251 Pipeline into the clearwells of the plant (**Figure 7.33**). This serves as an emergency supply should there be planned or unplanned downtime at the plant.

From the clearwells (**Table 7.32**) at the D.V. Harris WTP, potable water is supplied to the Clarendon, Belfort and Claridge Reservoirs, which feed the northern and eastern suburbs of The Msunduzi Municipality and Greater Wartburg and Table Mountain areas for uMgungundlovu District Municipality. The WTP also supplies potable water to the Umlaas Road Reservoir via the re-commissioned '53 Pipeline (**Table 7.27**) to feed areas within uMgungundlovu District Municipality and eThekweni Municipality.

Table 7.31 Characteristics of D.V. Harris WTP.

WTP Name:	D.V. Harris WTP
System:	Upper uMngeni System
Maximum Design Capacity:	125 Mℓ/day (100 Mℓ/day Main Plant and 25 Mℓ/day Dissolved Air Flotation)
Current Utilisation:	116.56 Mℓ/day
Raw Water Storage Capacity:	0 Mℓ
Raw Water Supply Capacity:	229 Mℓ/day
Pre-Oxidation Type:	Prechlorination
Primary Water Pre-Treatment Chemical:	Polymeric Coagulant
Total Coagulant Dosing Capacity:	
Rapid Mixing Method:	Hydraulic Jump
Clarifier Type:	Pulsator Clarifier
Number of Clarifiers:	4 (Main Plant)
Total Area of all Clarifiers:	1182 m ² (Main Plant)
Total Capacity of Clarifiers:	81.2 Mℓ/day (Main Plant)
Filter Type:	Slow Sand Filters
Number of Filters:	21 + 4 Dissolved Air Flotation
Filter Floor Type	
Total Filtration Area of all Filters	827.82 m ² Main Plant
Total Filtration Design Capacity of all Filters:	115 Mℓ/day Main Plant
Total Capacity of Backwash Water Tanks:	Backwash Water comes from Clearwell 1 – 1.38 Mℓ
Total Capacity of Sludge Treatment Plant:	
Capacity of Used Washwater System:	
Primary Post Disinfection Type:	Chloramination
Disinfection Dosing Capacity:	
Disinfectant Storage Capacity:	
Total Treated Water Storage Capacity:	5.52 Mℓ (Note there is no on-site reservoir, only clearwells)

Table 7.32 Details of the D.V. Harris clearwells.

System	Reservoir Site	Reservoir Name	Capacity (Mℓ)	Reservoir Function	TWL (mASL)	FL (mASL)
Upper uMngeni	D.V. Harris WTP	D.V. Harris Clearwells	5.52	Bulk	978.9	977.09

Table 7.33 Pipeline details: '51 Pipeline.

System	Pipeline Name	From	To	Length (km)	Nominal Diameter (mm)	Material	Capacity * (Mℓ/day)	Age (years)
Upper uMngeni	'51 Pipeline	Midmar Dam	D.V. Harris WTP	10.80	1 300	Concrete	229.68	65

* Based on a velocity of 2 m/s

(h) uMshwathi Sub-System

The D.V. Harris WTP supplies the uMshwathi BWSS (**Figure 7.36**). This includes supply to the Wartburg and Table Mountain areas for the uMgungundlovu District Municipality. Water is sold to The Msunduzi Municipality at the WTP and is then conveyed to the Belfort and Claridge Reservoirs. At this point, the water is “bought back” from Msunduzi Municipality to supply the Greater Wartburg area.

(i) Table Mountain Supply

Another “buy back” point further downstream of Msunduzi Municipality’s infrastructure is at Lower Glen Lyn, which supplies Table Mountain. uMngeni-uThukela Water purchases water from The Msunduzi Municipality at the municipality’s Lower Glen-Lyn Break-Pressure Tank. An off-take from the break-pressure tank supplies the Table Mountain Pipeline (**Table 7.34**), which feeds the Table Mountain Reservoir (**Table 7.36**). From the Table Mountain Reservoir, potable water is supplied to the rural communities in Table Mountain within the uMgungundlovu District Municipality.

(ii) ‘69 Pipeline (Claridge Reservoir to Wartburg Reservoir)

uMngeni-uThukela Water’s Wartburg Pipeline, also known as the ‘69 Pipeline, supplies potable water to the Albert Falls, Wartburg, Cool Air, New Hanover, Dalton and Swayimane areas (**Table 7.34**). Water is currently conveyed between D.V. Harris WTP and Claridge Reservoir along a 6.7 km long 1 000 mm diameter steel pipeline, which The Msunduzi Municipality owns. uMngeni-uThukela Water buys water back from The Msunduzi Municipality at Claridge Reservoir. Potable water from the Claridge Reservoir flows under gravity through the ‘69 Pipeline (see above) to the Wartburg Pump Station (**Table 7.35**). There are off-takes to Albert Falls, Mpolweni as well as private connections en-route. From the pump station, the ‘69 Pipeline continues as a rising main to the Wartburg Reservoir (**Table 7.36**).

Phases 1, 2 and 3 of the uMshwathi Regional Bulk Water Supply Scheme (BWSS) (**Section 7.5.2 (f)**) have been completed and fully commissioned. A new 800mm diameter pipeline has been constructed (Phase 1) in parallel to the existing 300 mm diameter pipeline from Claridge Reservoir to Wartburg. Similarly, a new pump station has been constructed to boost pressure in this line. The new pump station, named the Mpolweni Pump Station, was commissioned at the end of June 2019. The existing 300 mm diameter NB steel pipeline will be used as a back feed line from Wartburg Reservoir to supply the existing consumers along this line. Similarly, the existing 300 mm diameter NB steel section from Claridge Reservoir will be used to supply the existing consumers and the Albert Falls area.

(iii) Wartburg Reservoir to Bruyns Hill Reservoir

The 6 Mℓ Bruyns Hill Reservoir (**Table 7.36**) is supplied via a 250 mm diameter steel pipeline from the Wartburg Reservoir. The pipeline is initially a gravity line to the Bruyns Hill Pump Station (**Table 7.35**) and then a 250 mm diameter rising main to the Bruyns Hill Reservoir. A new pump station at Wartburg Reservoir and a 450 mm diameter steel rising main have been commissioned and will meet current and the projected demands of the Bruyns Hill Supply System.

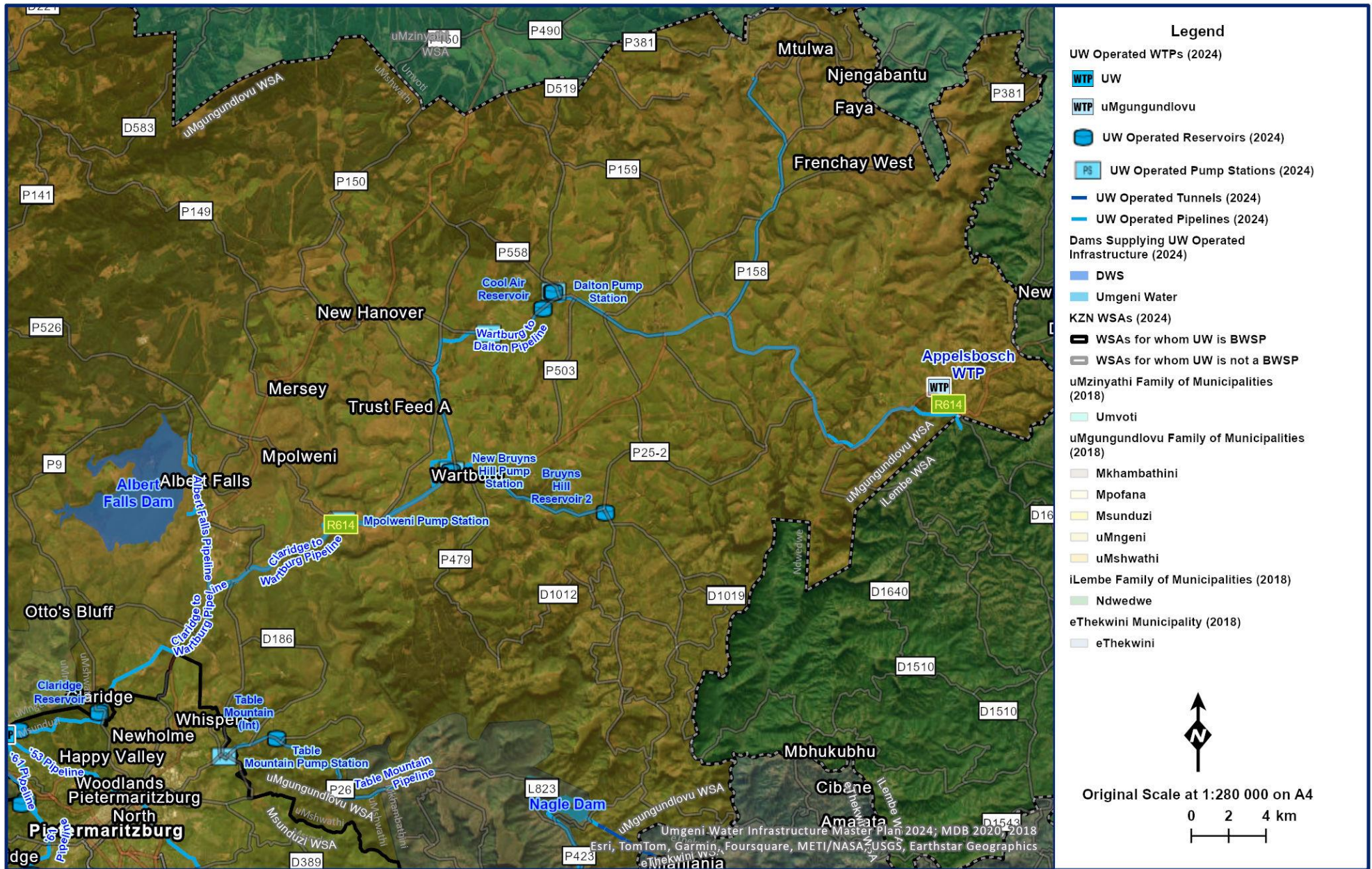

Figure 7.36 General layout of the uMshwathi Sub-System.

(iv) Wartburg to Dalton

Wartburg Reservoir supplies Cool Air Reservoir via the Dingle Pump Station (**Table 7.35**). En-route it supplies Trustfeeds and New Hanover. A further pump station at Cool Air Reservoir pumps water to Dalton Reservoir (**Table 7.36**).

Phase 2 of the uMshwati BWSS, which comprises the installation of a 700 mm diameter NB steel pipeline from Wartburg Reservoir to a newly constructed 10 Mℓ Dalton Reservoir and a new booster pump station has been completed and commissioned.

(v) Dalton to Ozwathini

Phase 3 of the uMshwati BWSS comprises the recently constructed 700 mm diameter NB steel pipeline from Dalton Reservoir to a 12 Mℓ Ozwathini Reservoir and a new booster pump station. The reservoir was completed at the end of August 2019.

There will be an off-take to the Efaye community and Montebello Hospital along this pipeline. The Ozwathini Reservoir supplies the Ozwathini and Appelsbosch supply zones. The Nondabulo reservoir supplies the iLembe Municipality.

Table 7.34 Pipeline details: Wartburg Sub-System.

System	Pipeline Name	From	To	Length (km)	Nominal Diameter (mm)	Material	Capacity (ME/day)	Age (years)
Upper uMngeni	Table Mountain Pipeline	Lower Glen Lyn BPT	Table Mountain Reservoir	14.80	125	uPVC	2.12*	65
Upper uMngeni	Wartburg Pipeline ('69 Pipeline)	Claridge Reservoir/Belfort Reservoir	Wartburg Break Pressure Tank and Pump Station	19.30	850	Steel	87**	7
Upper uMngeni	Wartburg Pipeline ('69 Pipeline)	Wartburg Break Pressure Tank and Pump Station	Wartburg Reservoir	6.80	850	Steel	87**	8
Upper uMngeni	Wartburg Pipeline	Wartburg Reservoir	Dingle Break Pressure Tank and Pump Station	9.50	250/200	FC	8.50/5.40*	33
Upper uMngeni	Wartburg Pipeline	Wartburg Reservoir	Dingle Break Pressure Tank and Pump Station	9.50	700	Steel	66	7
Upper uMngeni	Wartburg Pipeline	Dingle Break Pressure Tank and Pump Station	Cool Air Reservoir	13.90	160	FC	2.60***	33
Upper uMngeni	Wartburg Pipeline	Cool Air Reservoir	Dalton Pump Station and Reservoir	1.30	110	uPVC	1.64*	20
Upper uMngeni	Wartburg Pipeline	Dingle Break Pressure Tank and Pump Station	Cool Air Reservoir	13.90	700	Steel	66	7
Upper uMngeni	Wartburg Pipeline	Cool Air Reservoir	Dalton Pump Station and Reservoir	1.30	700	Steel	66	7
Upper uMngeni	Wartburg Pipeline	Dalton Reservoir	Nondabula Reservoir	20	700	Steel	66	7
Upper uMngeni	Bruyns Hill Pipeline	Wartburg Reservoir	Bruyns Hill Pump Station	9.50	250	mPVC	8.49*	27
Upper uMngeni	Bruyns Hill Pipeline	Bruyns Hill Pump Station	Bruyns Hill Reservoir (decommissioned in 2012)	3.69	250	uPVC	3.00***	
Upper uMngeni	Bruyns Hill Pipeline	Bruyns Hill Pump Station	Bruyns Hill Reservoir	3.69	250	Steel	8.50	13
Upper uMngeni	Wartburg Pipeline	Wartburg Break Pressure Tank	Mpolweni		160	uPVC	3.48*	26
Upper uMngeni	Albert Falls Pipeline	Wartburg Pipeline	Thokozani Reservoir	10.30	200	uPVC	5.44*	21

* Based on velocity of 2 m/s ** Restricted due to insufficient head *** Restricted due to pipe class

Table 7.35 Pump details: Wartburg Sub-System.

System	Pump Station Name	Pump Set	Pump Status		Pump Description	Supply From	Supply To	Static Head (m)	Duty Head (m)	Duty Capacity (Mℓ/day)
			Duty	Standby						
Upper uMngeni	Cool Air	Dalton Pump No 1	✓		KSB:ETA 40-250/5	Cool Air Reservoir	Dalton Reservoir	58.0	100.0	0.46
Upper uMngeni	Cool Air	Dalton Pump No 2		✓	KSB:ETA 40-250/5	Cool Air Reservoir	Dalton Reservoir	58.0	100.0	0.46
Upper uMngeni	Bruyns Hill	Pump No 1	✓		KSB:WKLN 80/2	Wartburg	Bruyns Hill	43.0	184	1.63
Upper uMngeni	Bruyns Hill	Pump No 2		✓	KSB:WKLN 80/2	Wartburg	Bruyns Hill	43.0	184	1.63
Upper uMngeni	Dingle	Pump No1	✓		KSB:WL 65/7	Wartburg	Cool-Air Reservoir	178	271	1.17
Upper uMngeni	Dingle	Pump no 2		✓	KSB:WL 65/7	Wartburg	Cool-Air Reservoir	178	271	1.17
Upper uMngeni	Table Mountain	Pump No 1	✓		KSB:ETA new 60-250	Lower Glen-Lyn	Table Mountain Reservoir	20.0	75.00	1.3
Upper uMngeni	Table Mountain	Pump No 2	✓		KSB:ETA new 50-250	Lower Glen-Lyn	Table Mountain Reservoir	20.0	75.00	1.3
Upper uMngeni	Table Mountain	Pump No 3		✓	KSB:F/A 50-250	Lower Glen-Lyn	Table Mountain Reservoir	20.0	75.00	1.3
Upper uMngeni	Old Wartburg	Pump No 1		✓	KSB:WKLn 5016 No	Wartburg Pipeline	Wartburg Reservoir	164.0	189.0	0.52
Upper uMngeni	Old Wartburg	Pump No 2		✓	KSB:WKLn 5016 No	Wartburg Pipeline	Wartburg Reservoir	164.0	189.0	0.52
Upper uMngeni	New Wartburg	Pump No 1	✓		KSB:WL -100/4	Wartburg Pipeline	Wartburg Reservoir	164.0	239.0	3.24
Upper uMngeni	New Wartburg	Pump No 2	✓		KSB:WL -100/4	Wartburg Pipeline	Wartburg Reservoir	164.0	239.0	3.24
Upper uMngeni	Mpolweni	Pump No 1	✓		Kiloskar SCT 300/77	Wartburg Pipeline	Wartburg Reservoir	23.5	123	39
Upper uMngeni	Mpolweni	Pump No 2	✓		Kiloskar SCT 300/77	Wartburg Pipeline	Wartburg Reservoir	23.5	123	39
Upper uMngeni	Mpolweni	Pump No 3		✓	Kiloskar SCT 300/77	Wartburg Pipeline	Wartburg Reservoir	23.5	123	39
Upper uMngeni	Dingle	Pump No 1	✓		KSB Omega 300-700B	Dalton Pipeline	Dalton Reservoir	178	271	22.89
Upper uMngeni	Dingle	Pump No 2		✓	KSB Omega 300-700B	Dalton Pipeline	Dalton Reservoir	178	271	22.89

Table 7.36 Reservoir details: Wartburg Sub-System.

System	Reservoir Site	Reservoir Name	Capacity (Mℓ)	Reservoir Function	TWL (mASL)	FL (mASL)
Upper uMngeni	Wartburg	Wartburg Reservoir 1	0.50	Distribution	963.5	958.4
Upper uMngeni	Wartburg	Wartburg Reservoir 2	1.50	Distribution	963.5	958.7
Upper uMngeni	Wartburg	Wartburg Reservoir 3	8.0	Distribution	963.5	956.2
Upper uMngeni	Belfort	Claridge Reservoir	50.00	Distribution	940.3	931.6
Upper uMngeni	Bruyns Hill	Bruyns Hill Reservoir 1	0.40	Distribution	1006.0	1002.0
Upper uMngeni	Bruyns Hill	Bruyns Hill Reservoir 2	6.00	Distribution	1006.0	1002.0
Upper uMngeni	Cool Air	Cool Air Reservoir	0.50	Distribution	1013.1	1008.3
Upper uMngeni	PMB East	Table Mountain (Int)	0.10	Distribution	909.0	907.0
Upper uMngeni	Dalton	Dalton	10	Distribution	1076.41	1067.01
Upper uMngeni	Ozwathini	Ozwathini	12	Distribution	1052.0	1045.0

(i) Lower uMngeni System

The Lower uMngeni System (**Figure 7.5** and **Figure 7.6**) serves the greater eThekweni Municipal area from lower Pinetown/KwaDabeka in the west, to Phoenix/Inanda/Verulam in the north, to the Durban seaboard in the east and to Amanzimtoti/KwaMakuta in the south. It also provides water to the northern coastal areas of Ugu District Municipality. The system derives its water resources from the uMngeni River, being fed from Nagle and Inanda Dams, which are supported by Albert Falls Dam, Midmar Dam and the MMTS.

Water is treated at uMngeni-uThukela Water's Durban Heights WTP (**Table 7.37**) located in Westville, Wiggins WTP (**Table 7.43**) located in Cato Manor and Maphephethwa WTP (**Table 7.48**) located in the Inanda Dam area. uMngeni-uThukela Water sells water to eThekweni Municipality "at the fence" of these WTPs and thus does not own nor operate the bulk distribution pipelines downstream of these WTPs. However, operational and infrastructure changes within the eThekweni Municipality's system, which is served by these WTPs, have a profound influence on the WTPs operational and infrastructure requirements.

Continuous effort (uMngeni-uThukela Water in collaboration with eThekweni Municipality) has gone into optimising the overall efficiency of the distribution system to share the load better between the two large WTPs. One example of these initiatives has involved the transfer of demand from areas previously supplied from Durban Heights WTP onto Wiggins WTP. This demand transfer commenced in January 2005 and involved the transfer of 40 - 60 Mℓ/day onto Wiggins WTP.

Durban Heights WTP has a rated capacity of 615 Mℓ/day. The primary raw water source for the WTP is Nagle Dam, which has limited storage and is in turn supplied from Albert Falls Dam located on the uMngeni River. Raw water is conveyed from Nagle Dam to Durban Heights WTP via two systems comprising a series of siphons and gravity tunnels. System 1, Nagle Aqueducts 1 and 2, comprises 11 tunnels (14.57 km) which are inter-connected by siphons (29.7 km) with a capacity of 260 Mℓ/day. System 2, Nagle Aqueducts 3 and 4 comprises 6 tunnels (21.3 km) which are inter-connected by siphons (15.4 km) with a capacity of 440 Mℓ/day.

Durban Heights WTP is primarily gravity-fed with raw water from Nagle Dam via Aqueducts 1 to 4 as shown in **Figure 7.37** and detailed in **Table 7.38**, **Table 7.39** and **Table 7.40**. Aqueducts 1 to 4 have a total design capacity of 700 Mℓ/day at a total head of 404 metres above sea level (mASL), which is the top water level (TWL) of Nagle Dam.

Table 7.37 Characteristics of the Durban Heights WTP.

WTP Name:	Durban Heights WTP
System:	Lower uMngeni System
Maximum Design Capacity:	615 Mℓ/day
Current Utilisation:	552 Mℓ/day
Raw Water Storage Capacity:	0 Mℓ
Raw Water Supply Capacity:	710 Mℓ/day
Pre-Oxidation Type:	Pre-chlorination
Primary Water Pre-Treatment Chemical:	Polymeric Coagulant
Total Coagulant Dosing Capacity:	Other
Rapid Mixing Method:	Hydraulic Jump
Clarifier Type:	Pulsator Clarifier
Number of Clarifiers:	18
Total Area of all Clarifiers:	6580 m ²
Total Capacity of Clarifiers:	611 Mℓ/day
Filter Type:	Constant Rate Rapid Gravity Filters
Number of Filters:	100
Filter Floor Type	Plate Design
Total Filtration Area of all Filters	6227 m ²
Total Filtration Design Capacity of all Filters:	615 Mℓ/day
Total Capacity of Backwash Water Tanks:	2326 m ³
Total Capacity of Sludge Treatment Plant:	30 000 kg/day of thin sludge
Capacity of Used Washwater System:	25.2 Mℓ/day
Primary Post Disinfection Type:	Chlorine gas
Disinfection Dosing Capacity:	
Disinfectant Storage Capacity:	24 ton
Total Treated Water Storage Capacity:	506 Mℓ

Raw water can be supplemented to Durban Heights WTP via the Inanda Pump Station through a 1 100 mm diameter NB steel pipeline connecting onto Aqueduct 1 and through the Durban Heights Shaft Pump Station which pumps water from the Wiggins Aqueduct (**Figure 7.37**).

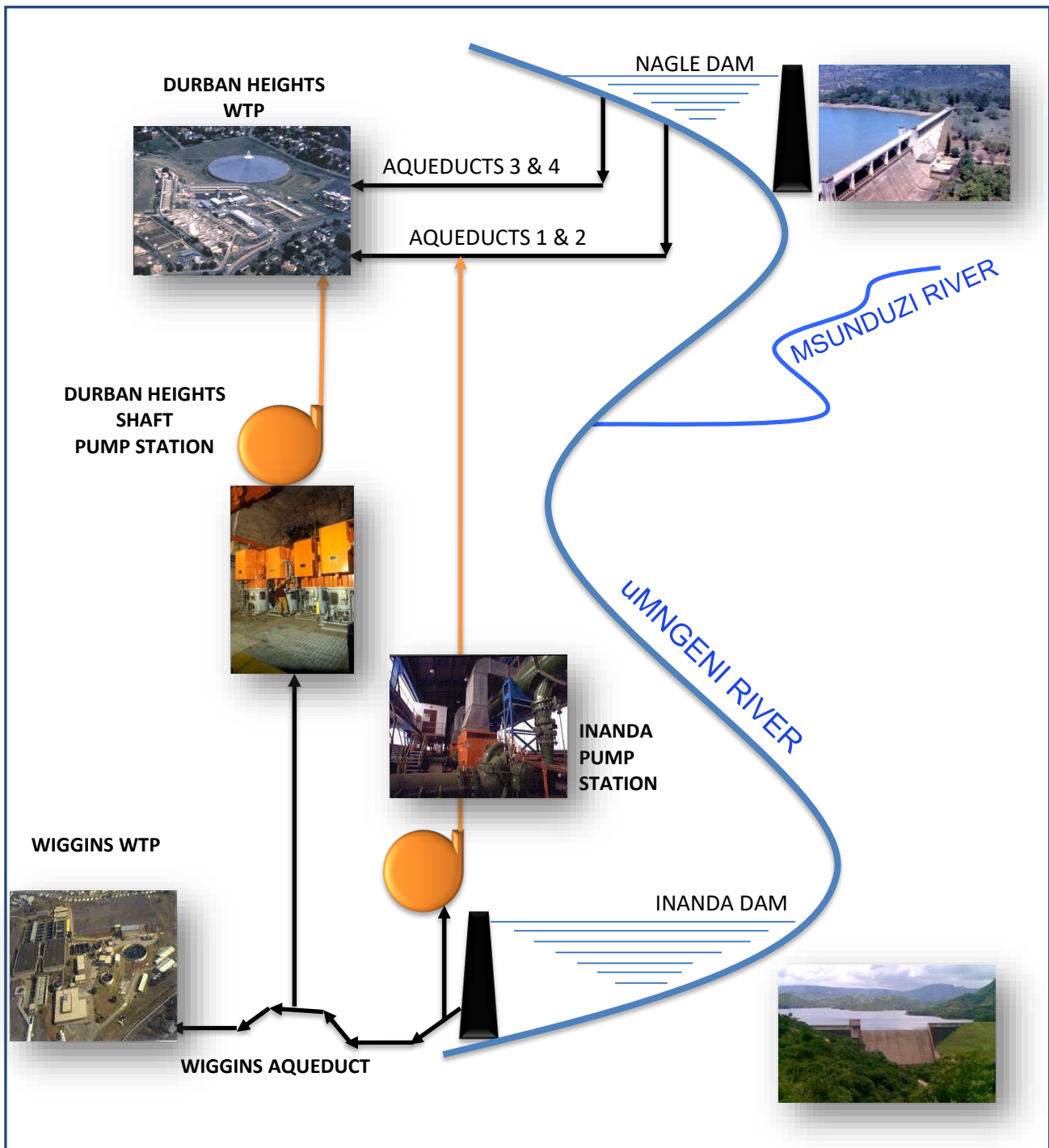

Figure 7.37 Layout of the Central Supply System.

Table 7.38 Tunnel details: Nagle Aqueduct System (Aqueduct 1 and 2).

System	Name	Total Length (m)	Height (m)	Radius (m)	Lining	Year Constructed	Transition	Semi-Arc
Lower uMngeni	Nagle Aqueduct 1 & 2 - Tunnel T1	533	1500	990	concrete lined	1949 & 1957		
	Nagle Aqueduct 1 & 2 - Tunnel T2	296	1500	990	concrete lined			
	Nagle Aqueduct 1 & 2 - Tunnel T3	861	1500	990	concrete lined			
	Nagle Aqueduct 1 & 2 - Tunnel T4	232	1500	990	concrete lined			
	Nagle Aqueduct 1 & 2 - Tunnel T5	3995	1500	990	concrete lined			
	Nagle Aqueduct 1 & 2 - Tunnel T6	2243	1500	990	concrete lined			
	Nagle Aqueduct 1 & 2 - Tunnel T7	1682	1500	990	concrete lined			
	Nagle Aqueduct 1 & 2 - Tunnel T8	996	1500	990	concrete lined			
	Nagle Aqueduct 1 & 2 - Tunnel T9	1246	1500	990	concrete lined			
	Nagle Aqueduct 1 & 2 - Tunnel T10	1751	1500	990	concrete lined			
	Nagle Aqueduct 1 & 2 - Tunnel T11	735	1500	990	concrete lined			

Table 7.39 Tunnel details: Nagle Aqueduct System (Aqueduct 3 and 4).

System	Name	Total Length (m)	Height (m)	Radius (m)	Lining	Year Constructed	Transition	Semi-Arc
Lower uMngeni	Nagle Aqueduct 3 & 4 - Umzwempi Tunnel T1	254	1505	1302	concrete lined - full	1967 & 1972		
		245			concrete lined - partial			
	Nagle Aqueduct 3 & 4 - Umbava Tunnel T2 Nagle Aqueduct 3 & 4 - Ngabayena Tunnel T2 Nagle Aqueduct 3 & 4 - Janokwe Tunnel T2 Nagle Aqueduct 3 & 4 - Shangase Tunnel T2 Nagle Aqueduct 3 & 4 - Ensutha Tunnel T2	1940	1505	1302	concrete lined - full			
		2866			concrete lined - partial			
					concrete lined - partial			
	Nagle Aqueduct 3 & 4 - Mkhizwane Tunnel T3 Nagle Aqueduct 3 & 4 - Nokwenzewa Tunnel T3	562	1746	978	concrete lined - full			
		3114			concrete lined - partial			
	Nagle Aqueduct 3 & 4 - Amabedhlana Tunnel T4 Nagle Aqueduct 3 & 4 - Showe Tunnel T4	1350	1505	1302	concrete lined - full			
		3281			concrete lined - partial			
	Nagle Aqueduct 3 & 4 - Langefontein Tunnel T5	1257	1505	1302	concrete lined			
3585		concrete lined - partial						
Nagle Aqueduct 3 & 4 - Kraanskloof Tunnel T6	1210	1505	1302	concrete lined				
	1677			concrete lined - partial				

Note: Tunnel 3 has a different cross section shape to tunnels 1, 2, 4, 5 and 6

Table 7.40 Siphon Pipeline details: Nagle Aqueducts.

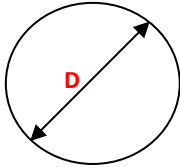
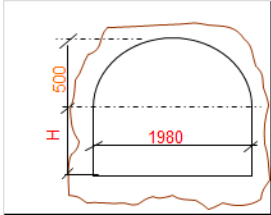
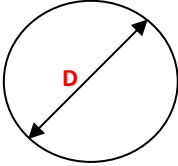
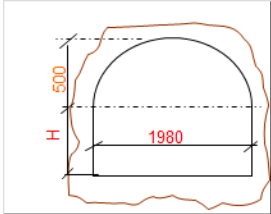
System	Pipeline Name	From	To	Length (km)	Nominal Diameter (mm)	Material	Capacity (Mℓ/day)	Age (years)
Lower uMngeni	Aqueduct 1	Nagle Dam	Durban Heights WTP	29.7	900	Steel	100	75
Lower uMngeni	Aqueduct 2	Nagle Dam	Durban Heights WTP	29.7	1 000	PCP and Steel	160	67
Lower uMngeni	Aqueduct 3	Nagle Dam	Durban Heights WTP	15.4	1 400	PCP	220	57
Lower uMngeni	Aqueduct 4	Nagle Dam	Durban Heights WTP	15.4	1 400	PCP	220	52

Table 7.41 Reservoir details: Durban Heights WTP.

System	Reservoir Site	Reservoir Name	Capacity (Mℓ)	Reservoir Function	TWL (mASL)	FL (mASL)
Lower uMngeni	Durban Heights	Reservoir 1	45	Bulk	264.84	259
Lower uMngeni	Durban Heights	Reservoir 2	100	Bulk	272	265
Lower uMngeni	Durban Heights	Reservoir 3	343	Bulk	272	247
Lower uMngeni	Durban Heights	Dunkeld Reservoir*	9	Bulk	264.84	259

* Owned by EWS

Table 7.42 Pump details: Durban Heights WTP.

System	Pump Station Name	Number of Pumps		Pump Description	Supply From	Supply To	Static Head (m)	Duty Head (m)	Duty Capacity (Mℓ/day)
		Number of Duty Pumps	Number of Standby Pumps						
Lower uMngeni	Durban Heights Booster Pump Station	4	1	KSB Omega 200-670	Durban Heights	eThekwini Northern Aqueduct	104	35	110
Lower uMngeni	Durban Heights Shaft Pump Station	3	1	Sulzer Bbk 620-022 4 stage	Wiggins Aqueduct	Durban Heights WTP	152	180	50
Lower uMngeni	Inanda Pump Station	3	1	Sulzer SM 303-800	Inanda Dam	Durban Heights WTP	140	200	50

Table 7.43 Characteristics of the Wiggins WTP.

WTP Name:	Wiggins WTP
System:	Lower uMngeni System
Maximum Design Capacity:	350 Mℓ/day
Current Utilisation:	319 Mℓ/day
Raw Water Storage Capacity:	0 Mℓ
Raw Water Supply Capacity:	350 Mℓ/day
Pre-Oxidation Type:	Ozone
Primary Water Pre-Treatment Chemical:	Polymeric Coagulant
Total Coagulant Dosing Capacity:	Polymeric Coagulant
Rapid Mixing Method:	Hydraulic Jump
Clarifier Type:	Pulsator Clarifier
Number of Clarifiers:	4
Total Area of all Clarifiers:	3980 m ²
Total Capacity of Clarifiers:	360 Mℓ/day
Filter Type:	Constant Rate Rapid Gravity Filters
Number of Filters:	24
Filter Floor Type	Monolithic
Total Filtration Area of all Filters	6688 m ²
Total Filtration Design Capacity of all Filters:	350.16 Mℓ/day
Total Capacity of Backwash Water Tanks:	
Total Capacity of Sludge Treatment Plant:	
Capacity of Used Washwater System:	2.78 Mℓ/day
Primary Post Disinfection Type:	Hypochlorite
Disinfection Dosing Capacity:	240 ℓ/hr
Disinfectant Storage Capacity:	
Total Treated Water Storage Capacity:	120 Mℓ

Wiggins WTP is primarily gravity-fed with raw water from Inanda Dam via the Wiggins Aqueduct (**Figure 7.37** and **Table 7.44** and **Table 7.45**). The Wiggins Aqueduct has a total design capacity of 350 Mℓ/day at a total head of 147 mASL, which is the top water level (TWL) of Inanda Dam.

Table 7.44 Tunnel details: Inanda-Wiggins Aqueduct System.

System	Name	Total Length (m)	Height (m)	Radius (m)	Lining	Year Constructed	Transition	Semi-Arc
Lower uMngeni	Inanda Wiggins Aqueduct - Emolweni Tunnel	5320	1350	1220	steel lined	1993		
Lower uMngeni	Inanda Wiggins Aqueduct - Clermont Tunnel	5400	1350	1220	steel lined	1993		
Lower uMngeni	Inanda Wiggins Aqueduct - Reservoir Tunnel	2560	1350	925	steel lined	1984		
Lower uMngeni	Inanda Wiggins Aqueduct - University Tunnel	1040	1350	925	steel lined	1984		
Lower uMngeni	Inanda Wiggins Aqueduct - Sherwood Tunnel	3350	1350	925	steel lined	1984		

Table 7.45 Pipeline details: Inanda-Wiggins Aqueduct.

System	Pipeline Name	From	To	Length (km)	Nominal Diameter (mm)	Material	Capacity (Mℓ/day)	Age (years)
Lower uMngeni	Inanda Wiggins Aqueduct	Inanda Dam	Durban Heights WTP	11.8	2620	Steel	550	31
Lower uMngeni	Inanda Wiggins Aqueduct	Durban Heights WTP	Wiggins WTP	5.9	2315	Steel	350	40

Table 7.46 Reservoir details: Wiggins WTP.

System	Reservoir Site	Reservoir Name	Capacity (Mℓ)	Reservoir Function	TWL (mASL)	FL (mASL)
Lower uMngeni	Wiggins	Reservoir 1	120	Bulk	103	96.6

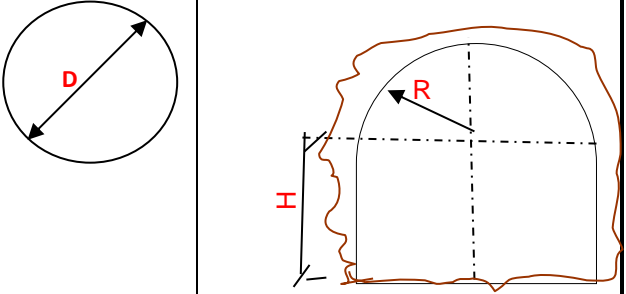
Table 7.47 Pump details: Wiggins WTP.

System	Pump Station Name	Number of Pumps		Pump Description	Supply From	Supply To	Static Head (m)	Duty Head (m)	Duty Capacity (Mℓ/day)
		Number of Duty Pumps	Number of Standby Pumps						
Lower uMngeni	Wiggins High Lift Pumps (small)	2	1	APE 300-300-370 HMNA	Wiggins WTP	Ridge Reservoir/Lamont Reservoir	31	130	28
Lower uMngeni	Wiggins High Lift Pumps (big)	1	1	APE Model 6920 5-stage	Wiggins WTP	Ridge Reservoir/Lamont Reservoir	31	130	108

Table 7.48 Characteristics of the Maphephethwa WTP.

WTP Name:	Maphephethwa WTP (upgrade commissioned in December 2015)
System:	Lower uMgeni System
Maximum Design Capacity:	5 Mℓ/day
Current Utilisation:	4.3 Mℓ/day
Raw Water Storage Capacity:	None
Raw Water Supply Capacity:	5.3 Mℓ/day
Pre-Oxidation Type:	Chlorine
Primary Water Pre-Treatment Chemical:	Aluminium Sulphate
Total Coagulant Dosing Capacity:	250 kg/day at 50 mg/ℓ (maximum)
Rapid Mixing Method:	Flow over weirs
Clarifier Type:	Circular clarifiers with mechanical sludge scrapers
Number of Clarifiers:	2
Total Area of all Clarifiers:	226 m ²
Total Capacity of Clarifiers:	5 Mℓ/day
Filter Type:	Rapid Gravity Filters
Number of Filters:	4
Filter Floor Type	Monolithic
Total Filtration Area of all Filters	50 m ²
Total Filtration Design Capacity of all Filters:	5 Mℓ/day
Total Capacity of Backwash Water Tanks:	195 m ³
Total Capacity of Sludge Treatment Plant:	5 Mℓ/day
Capacity of Used Washwater System:	11.7 m ³ /day
Primary Post Disinfection Type:	Gaseous Chlorine
Disinfection Dosing Capacity:	1.5 kg/hr
Disinfectant Storage Capacity:	70 kg cylinders with automatic changeover
Total Treated Water Storage Capacity:	2.5 Mℓ

7.3.2 Status Quo and Limitations of the uMngeni System

(a) Overview

The current demand off the Upper uMngeni System is approximately 389 Mℓ/day. **Figure 7.38** illustrates the distribution of this demand between the three WSAs.

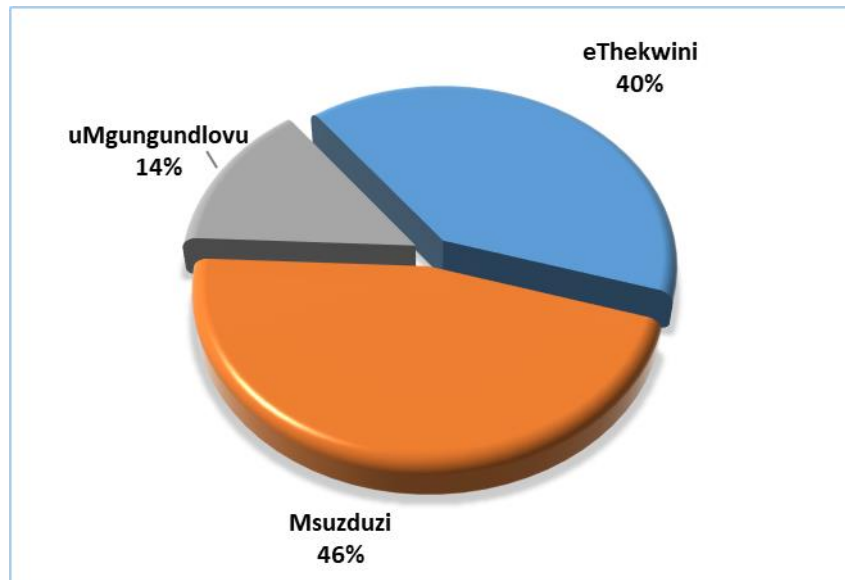

Figure 7.38 Distribution of Demands in Upper uMngeni per WSAs (October 2023).

Over recent years, eThekweni Municipality has made an effort into optimising the operation of its distribution systems that are served by the Lower uMngeni System. Amongst other things, this has led to them implementing new infrastructure in order to undertake a load shifting exercise.

eThekweni Municipality's Western Aqueduct project, which was fully commissioned in 2020, represents the most significant of these load-shifting operations. The intention is for those areas, currently being served under pumping from the Lower uMngeni System (viz. from Durban Heights WTP), to be transferred onto the Upper uMngeni System, and served under gravity from Midmar WTP via the Western Aqueduct (WA). These areas include Greater Inanda, KwaDabeka, Mt Moriah and Pinetown South. Further to this, eThekweni Municipality plans to link the WA into their Northern Aqueduct thereby extending this supply to the municipality's northern areas as far as the Dube TradePort Development Zone. Whilst this measure will free up additional capacity within the Lower uMngeni System, which can then be redirected elsewhere within eThekweni Municipality, it does place considerable additional load on much of uMngeni-uThukela Water's infrastructure in the Upper uMngeni System. This includes the '57, '61 and '251 Pipeline systems, Midmar WTP, and ultimately on the water resources available from Midmar Dam (**Section 7.2.3 (a)**). The augmentation of the '57 Pipeline (completed in 2011) and the '61 pipeline (commissioned in 2014) were undertaken in order to provide sufficient capacity in this portion of the supply network to meet the required demands of the WA.

With the completion of the second phase of the MMTS (**Section 7.2.3 (a)**), the 99% assured yield of the uMngeni System, at Midmar Dam, has increased from 322.5 Mℓ/day (117.7 million m³/annum) to 476.2 Mℓ/day (173.8 million m³/annum). However, even an increased yield at Midmar Dam will be

insufficient to support the proposed full Western Aqueduct load shift for any significant period of time, and further water resource developments will be required to serve the increasing demand of eThekweni Municipality. However, additional water resource developments within the Mooi-uMngeni system are not considered to be beneficial as this catchment is now considered fully utilised. An alternative water resource option that is currently being investigated is the uMkhomazi Water Project (uMWP) (**Section 7.5.2 (a)**) which would transfer raw water from the uMkhomazi River to a WTP near Baynesfield, with potable water then being supplied to the Umlaas Road area to feed into the '57 Pipeline and subsequently into the WA. A detailed feasibility study of the uMWP is now complete and an EIA is being undertaken for the project. The earliest that it is envisaged that the scheme could be completed and operational is 2035

Midmar Dam's yield has now been maximised following the completion of phase 2 of the MMTS. It is prudent that all future bulk distribution infrastructure upgrades within the Upper uMngeni System (Midmar WTP - Umlaas Road) be limited to the water resources capacity that Midmar Dam can support (bearing in mind that Midmar Dam must also contribute to the water resource requirements downstream of it).

An assessment was undertaken in 2014 to determine the "load shift potential from the Lower uMngeni System to the Upper uMngeni System" (**Section 7.2.2 (e)**). EWS have requested that uMngeni-uThukela Water provide additional water to Umbumbulu to satisfy future demand growth. EWS agreed that this additional demand would decrease the availability of water at Point 'M'. The total available for eThekweni Municipality along the WA, with the load shift to Umbumbulu Reservoir is an initial 173.57 Mℓ/day in 2019 decreasing to 70.38 Mℓ/day by 2030.

As mentioned in **Section 7.2.2 (e)**, only 330 Mℓ/day is available through the '61 System after the tunnel. Significant infrastructure costs would have to be incurred to overcome this hydraulic constraint, and taking into account, the water resource constraint mentioned above, this upgrade is not considered practical.

Hence, the water available to meet demands downstream of Umlaas Road Reservoir is limited until the uMWP is commissioned. Further to this, the available water for eThekweni Municipality will decrease over time as the demands upstream of the Umlaas Road Reservoir increase. The full WA load shift requirement will not be accommodated by the Upper uMngeni System until the uMWP is commissioned.

(b) Midmar Water Treatment Plant

The demand placed on the Midmar Water Treatment Plant, over the past few years, is presented in **Figure 7.39**. Forecast sales are shown on the same figure. The current average WTP production is approximately 389 Mℓ/day.

The steep increase in supply is due to Msunduzi Municipality's demand along the '61 Pipeline Supply System exceeding the projected demand. It is further strained due to an increase in supply to eThekweni Municipality's demand to point M. eThekweni Municipality commissioned the Western Aqueduct and have requested that uMngeni-uThukela Water supply the maximum of 200 Mℓ/day during commissioning and thereafter supply the demand as projected.

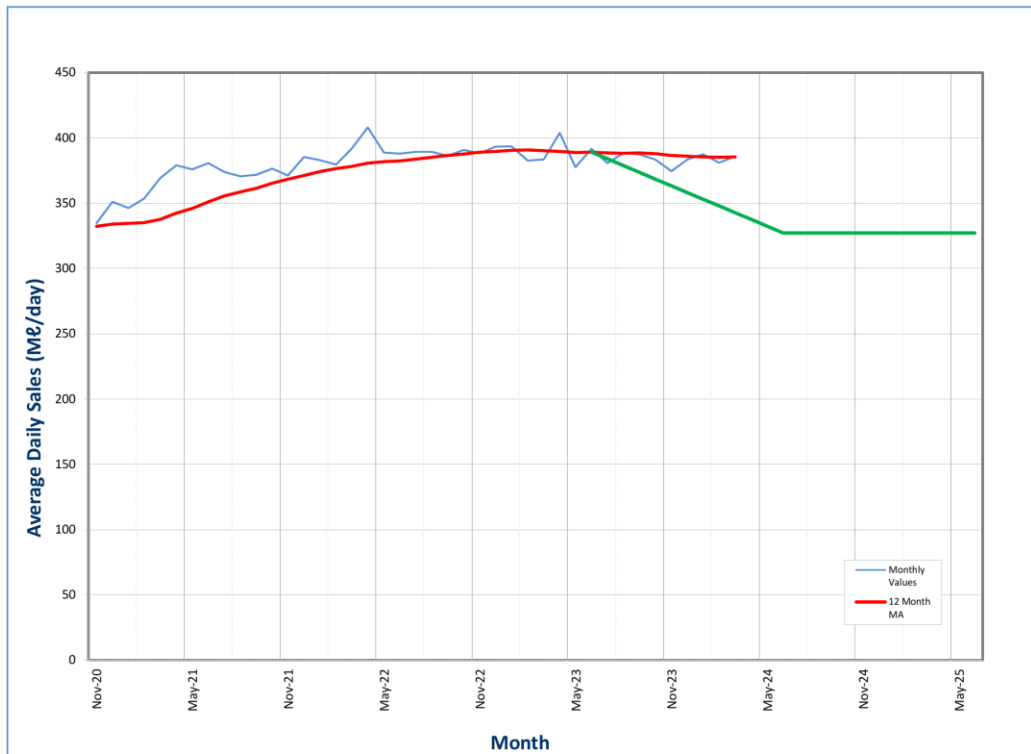

Figure 7.39 Water demand from Midmar WTP.

An analysis of daily historical production (November 2022 to October 2023) of the Midmar WTP is presented in **Figure 7.40**. It shows that for 98.09% of the time the WTP was being operated above the optimal operating capacity and 0% above its design capacity. This is an increase from the 97.82% above the optimal operating capacity of the previous reporting period. The result of this is that WSA's are going to be prohibited from implementing any new developments because UUW will not have the infrastructure capacity to meet the projected demand. The Department of Water and Sanitation (DWS) have issued a directive to UUW to observe the abstraction licence agreement along the uMngeni System. Discussions with UMDM, Msunduzi Municipality and eThekweni Metropolitan Municipality on demand projections, have proposed and agreed to reduce demand over the next four years if abstraction licence conditions are to be met.

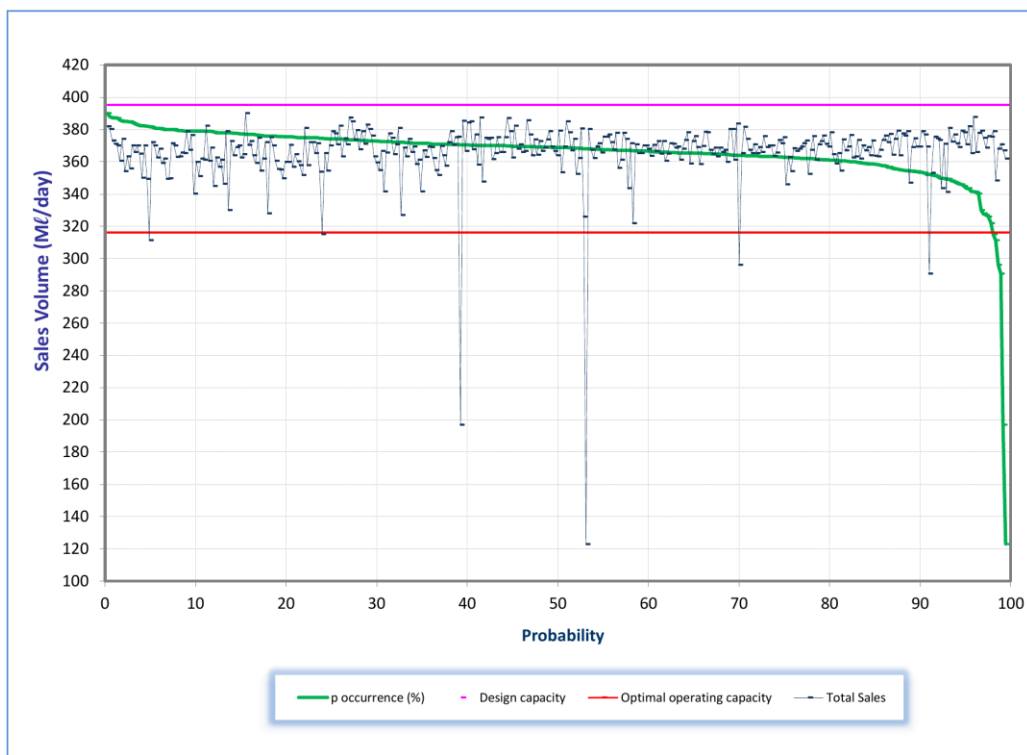

Figure 7.40 Analysis of historical production at Midmar WTP (November 2022 to October 2023).

(c) Howick-North Sub-System

(i) Mill Falls Pump Station to Howick-North Reservoirs

The Howick North Reservoir Complex (6.6 Mℓ) functions as a terminal reservoir under the current operating conditions. With the current average demand at 4.6 Mℓ/day, the reservoir does not have enough storage to meet its 48-hour storage requirement. A new reservoir, at a higher level, is proposed, to supply future developments. This reservoir, which needs to be constructed by uMgungundlovu District Municipality, will be supplied from the Howick-North Reservoir Complex. The Howick-North Reservoir Complex will thereafter become a distribution reservoir.

The pumps at Mill Falls and the pipeline to the reservoir were recently upgraded and hence there is sufficient capacity, when the additional resource becomes available from the Mkhomazi Water Project, in this infrastructure for the foreseeable future.

(d) Howick-West Sub-System

(i) Mill Falls Pump Station to Howick-West Reservoir

The pump station and pipeline to Howick-West Reservoir have adequate capacity to serve the short to medium-term demands of Howick-West, Mphomeni and Groenekloof demands. A review of this

system will have to be undertaken for the long-term demand when the upgraded Vulindlela phases 1 and 2 is commissioned.

(ii) Howick-West Reservoir to Groenekloof Reservoir

The Howick-West Reservoir (16.5 Mℓ) serves as a distribution reservoir with bulk supply lines to Groenekloof and Mpophomeni Reservoirs, and with direct supply into the Howick-West reticulation network. The current demand on this reservoir is approximately 48.9 Mℓ/day.

Water is pumped from the Howick-West Reservoir to Mpophomeni Reservoir (an uMgungundlovu District Municipality reservoir). Off-takes from this pumping main have the effect of continuously changing the system curve which affects the duty point of the pumps.

uMngeni Local Municipality planning includes a low cost housing development of 1500 units adjacent to Mpophomeni. This development will be phased with the first 500 units expected to be occupied in mid-2024. Phase 1 will result in a 300 kℓ/day increase in demand, which will cause the current demand to exceed the capacity of the Mpophomeni pipeline. New infrastructure will be required to meet the future demands.

(iii) Groenekloof Reservoir Supply

The 17.3 Mℓ Groenekloof Reservoir serves as a balancing reservoir for Vulindlela, Sweetwaters and Blackridge. The current demand out of Groenekloof Reservoir is 42.56 Mℓ/day. This demand is expected to increase to 45 Mℓ/day by 2030 when 24 Mℓ of storage will be required (**Section 7.4.2 (h)**). The high lift pumps to Vulindlela Reservoirs 2-5 have a capacity of approximately 22 Mℓ/day which meets the current demand of 22 Mℓ/day. Towards the end of 2025, Phase 1 of the Vulindlela BWSS will be implemented and Phase 2 by the end of 2027. This will result in the Vulindlela High-Lift pumps at Groenekloof to be decommissioned and the storage capacity at Groenekloof will be re-assessed.

The high lift pump impellers were upgraded and this has increased the pumping capacity to accommodate the current demand.

(iv) Blackridge Reservoir Supply

The current demand from the Blackridge Reservoir is approximately 1.47 Mℓ/day. The capacity of the reservoir is 2.2 Mℓ. The reservoir functions as a terminal reservoir that should ideally have 48 hours of storage (3.8Mℓ). This is a reticulation requirement and the responsibility for the upgrade, therefore lies with the Municipality.

(e) Midmar WTP to Umlaas Road Sub-System

(i) '251 Pipeline: Midmar WTP to D.V. Harris Off-Take

Due to limiting head conditions in the upper portion of the '251 Pipeline, the maximum flow obtainable through this pipeline is 330 Mℓ/day. Augmentation of all pipeline elements downstream of the '251 Pipeline should therefore be based on a maximum available flow of 330 Mℓ/day.

(ii) Clarendon Reservoir

The current demand from Clarendon Reservoir is approximately 23.9 Mℓ/day. The capacity of the reservoir is 25 Mℓ. The reservoir function is a terminal reservoir, which should have 48 hours of

storage. The Clarendon reservoir should therefore be upgraded to minimise risk. This is a reticulation requirement and the responsibility to provide this storage requirement lies with the Municipality. The Msunduzi Municipalities operational philosophy, includes the demands supply zones from Symons and Hathorns to be included off Clarendon Reservoir.

(iii) '61 Pipeline: D.V. Harris to World's View Reservoir

This section of pipeline has been augmented to accommodate the maximum flow of 330 Mℓ/day. The Worlds View reservoir has two 40 Mℓ compartments and the current throughput is approximately 334.4 Mℓ/day.

(iv) '61 Pipeline: World's View Reservoir to ED2

This dedicated pipeline serving The Msunduzi Municipality has sufficient capacity to satisfy the growing annual average daily demand (AADD). For a peak flow of 1.3 x AADD the pipeline could reach its capacity by 2030. However, with the proposed interlinking of the two '61 pipelines and the anticipated relief from the '61 Pipeline of the WA demand, once the uMWP is commissioned, the current pipeline capacity is considered adequate.

(v) '61 Pipeline: ED2 to Umlaas Road Reservoir

The Msunduzi Municipality plans to formalise the low-income housing in the Shenstone/Ambledon area. These developments will be supplied with potable water from the ED4 off-take. It is therefore expected that the increase in demand at this point will be in the region of 1.5% annually over the next 5 years. Further downstream of the ED4 off-take is the tie-in to the Richmond pipeline. This pipeline has an increased total demand of 16 Mℓ/day on this section due to the Shenstone and Ambledon demands.

A 1300 mm diameter pipeline was constructed, from ED2 to the Richmond off-take in 2012 to augment the 800 mm diameter pipeline. This will ensure adequate capacity for growth in demand towards 2030 when the uMWP is commissioned.

(vi) ED4 to Umlaas Road

The dual 61' Pipelines from ED4 to Umlaas Road have sufficient capacity to supply the current and future needs of the Umlaas Road Demand Zone. The demand at this zone will decrease once the uMWP is commissioned.

(vii) Ashburton Supply

The average flow in this pipeline is currently 1.20 Mℓ/day. This system has sufficient capacity for the short and medium term.

(viii) Thornville / Hopewell Supply

The average demand through this pipeline is currently 3.13 Mℓ/day. Thornville Reservoir is now supplied from the Richmond pipeline via the Lilliefontein Reservoir and the existing Thornville Pump Station only supplies the area of Thornville when the operational need exists. When the Thornville Pump Station is not operational then the rising main from the '61 Pipeline to Thornville operates as a back-feed gravity main.

(ix) '53 Pipeline: D. V. Harris WTP to Umlaas Road Reservoir

This pipeline currently supplies approximately 30.0 Mℓ/day to Umlaas Road Reservoirs. This ageing pipeline has an operational history of frequent bursts and caution has to be taken to not exceed the current “safe load carrying capacity” of 35 Mℓ/day.

(f) Umlaas Road Sub-System

The current demand at Umlaas Road Reservoir is 199.51 Mℓ/day with an increase of 24.51 Mℓ/day from 175 Mℓ/day last financial year. The reservoir serves primarily as a distribution reservoir, supplying reservoirs in Mkhambathini Municipality and eThekweni Municipality.

(i) '57 Pipeline

The existing 800 mm diameter pipeline serves a minimal demand in Camperdown. The combined capacity of the 1000mm diameter and the new 1600 mm diameter pipeline is 485 Mℓ/day, which is sufficient to satisfy the future demands of the WA.

(ii) Eston/Umbumbulu Pipeline

The capacity of this pipeline is restricted to 15 Mℓ/day due to the ground level profile along the pipeline route. The flow is restricted to ensure that the hydraulic grade line is at least 20 m above a high point at Stoney Ridge. The current flow in this pipeline is 18.37 Mℓ/day. uMgungundlovu District Municipality supplies the Greater Eston area with potable water from this pipeline.

EWS have requested that uMngeni-uThukela Water provide additional water to Umbumbulu to satisfy future demand growth in the area. This demand growth due to planned and unplanned commercial and residential developments in Umbumbulu as well as a load shed of a portion of Adams Mission onto the Umbumbulu Reservoir. This means that the capacity of this pipeline is insufficient to meet the current demands. uMngeni-uThukela Water has implemented the Umbumbulu Booster Pump Station as a short-term solution to meet the rapid growth in demand and a pipeline augmentation in the medium to long term.

(iii) Lion Park / Manyavu Pipeline

The current demand on this pipeline is approximately 5.03 Mℓ/day. uMngeni-uThukela Water constructed a pipeline from an off-take on the Lion Park Pipeline to serve the Manyavu community (circa 2007). The Manyavu demand was expected to grow to about 6 Mℓ/day by 2040. uMngeni-uThukela Water has recently augmented the Lion Park Pipeline by constructing a new 350 mm diameter steel pipeline to ensure the sustainability of the supply to this area.

(g) D.V. Harris Water Treatment Plant

The demand on the plant is made up of supply to the Msunduzi and uMshwathi Municipalities, as well as a supply to the Umlaas Road Reservoir via the '53 Pipeline. The supply through the '53 Pipeline varies between 25 to 35 Mℓ/day depending on the operational requirements at Umlaas Road Reservoir. While Clarendon can be supplied from the Midmar WTP, the current operating rule is to supply Clarendon Reservoir from D.V. Harris WTP to maximise the availability on the '251 pipeline to serve the Umlaas Road Sub-System.

Due to the configuration of the '61 Pipelines between D. V. Harris WTP and Clarendon Reservoir (**Figure 7.32**), it is expected that Clarendon Reservoir will have to be fed from Midmar WTP on a continuous basis going forward. The demand on the plant will be reduced if the '53 Pipeline is decommissioned when the uMWP is commissioned towards the year 2035. D.V. Harris WTP will therefore not have to be upgraded in the short to medium term.

The demand placed on the plant over the past few years is presented in **Figure 7.41**. Projected sales over the next year are also shown in the same figure. The current production at the plant is approximately 116.7 Mℓ/day.

The uMshwati BWSS has now been fully commissioned. The expected demand increased as potable water was supplied to the areas of Cool Air, Dalton, Ozwathini, eNadi, Efaye and Swayimana.

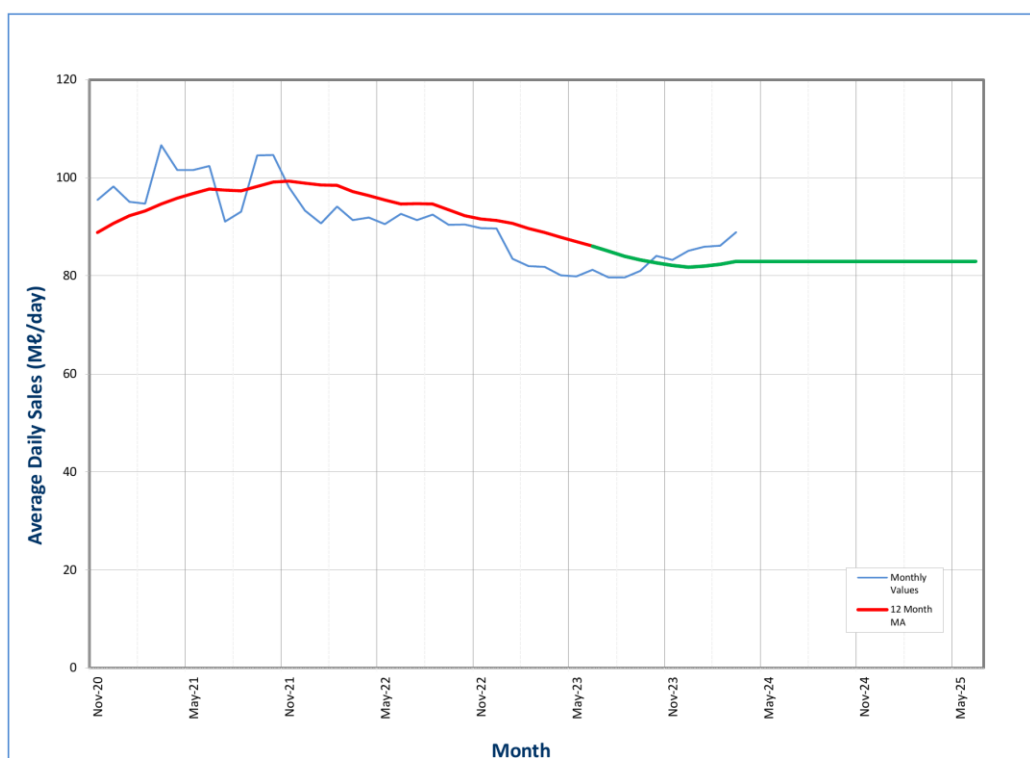

Figure 7.41 Water demand from D. V. Harris WTP.

An analysis of daily historical production (November 2022 to October 2023) of the D.V. Harris WTP is presented in **Figure 7.42**. It shows that for 93.7% of the time the WTP was being operated above the optimal operating capacity when compared to 97.8% over the previous year. The plant operated above design capacity for 2.7% of the time compared to 66.7% in the previous year. This is an alarming trend for both WTP's and discussions with the WSA's are ongoing to reduce the Non-Revenue Water component as this is the biggest contributor to the growing demand off the WTP's. The Department of Water and Sanitation (DWS) have issued a pre-directive to UJW to observe the abstraction license agreement along the uMngeni System. Discussions with UMDM and Msunduzi Municipality on

demand projections have proposed and agreed to reduce demand over the next two years for the abstraction licence conditions to be met.

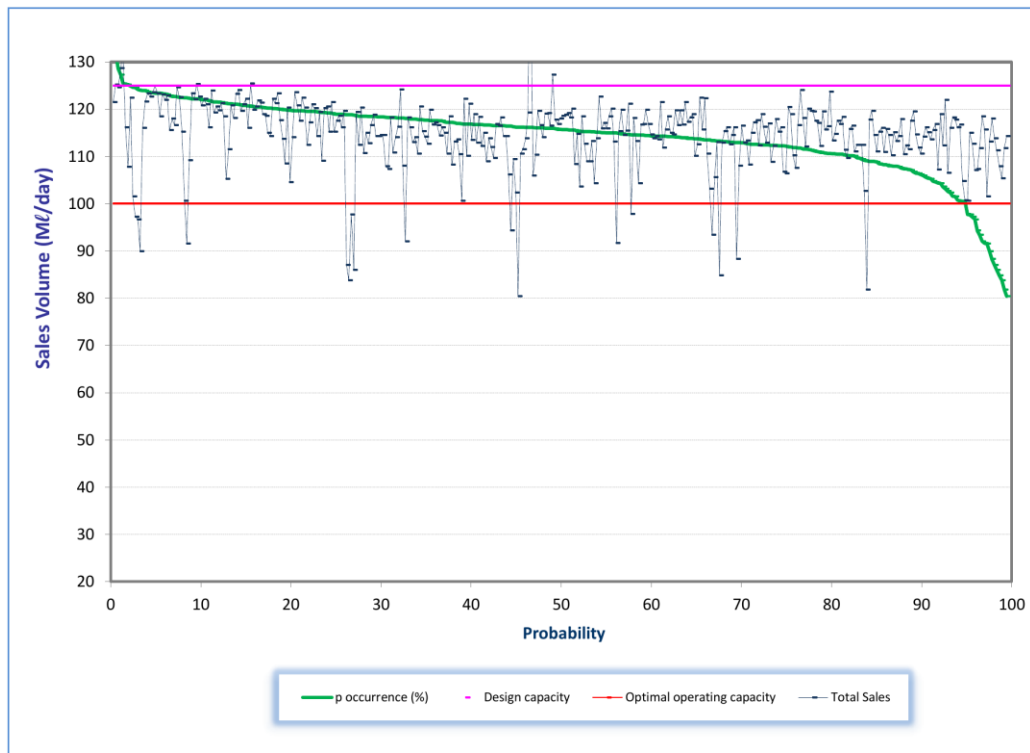

Figure 7.42 Analysis of historical production at D.V. Harris WTP (November 2022 to October 2023).

(h) uMshwathi Sub- System

(i) Msunduzi Supply

The current total supply to the Msunduzi pipeline (Belfort and Claridge reservoirs) from DV Harris WTW is 60.7 Mℓ/day. Apart from unplanned infill residential development, no major developments are planned that will impact substantially on the storage requirement at Claridge Reservoir.

(ii) '69 Pipeline: Claridge Reservoir to Wartburg Reservoir

The '69 Pipeline has recently been upgraded to supply the uMshwathi Municipality and the western areas of iLembe District Municipality. This pipeline has been fully commissioned and the “old” pipeline is systematically being decommissioned. The total demand through the system at present is approximately 19.1 Mℓ/day.

(iii) Wartburg Reservoir to Bruyns Hill Reservoir

The Wartburg Reservoir functions primarily as a bulk reservoir for the Bruyns Hill and Cool Air Reservoirs. To function as a bulk reservoir, it should have 15 hours of the AADD supply to Cool Air and Bruyns Hill Reservoirs.

Water demands from the Swayimane area have consistently increased over the years. This growth is expected to continue with the planning of further low cost housing in the area. iLembe District Municipality has also requested a supply to its Southern Ndwedwe region from Bruyns Hill.

The pipeline from Bruyns Hill Pump Station to Bruyns Hill Reservoir has been upgraded to a 250 mm diameter steel pipe, which has a capacity of 8.5 Mℓ/day. The supply from Wartburg Reservoir to Bruyns Hill Pump Station has been completed and can now support this new demand node, relieving the hydraulic constraint between Wartburg Reservoir and Bruyns Hill Pump Station. The storage capacity at Bruyns Hill Reservoir has been increased and should be adequate for the next 20 years.

(iv) Wartburg Reservoir to Dalton Reservoir

The supply pipelines from Wartburg Reservoir to the 10 Mℓ Dalton are adequate for the current demand. Phases 2 and 3 of the uMshwathi BWSS are complete and commissioned.

(i) Durban Heights Water Treatment Plant

Construction of the 400 Mℓ/day Western Aqueduct (WA) has now been commissioned by eThekweni Municipality (excluding Contract 5, which has been postponed to 2025). Sub-systems supplied from Durban Heights WTP and which are planned to be transferred to the WA include: Outer and Inner West, Tshelimnyama, Pinetown, Kwadabeka, Ntuzuma and Mzinyathi. Water currently available from Point M to the WA, based on the 1:100 year yield from the uMngeni system, is approximately 200 Mℓ/day until the proposed uMkhomazi Water Project (uMWP) is commissioned (**Section 7.4.2 (a)**).

eThekweni Municipality plan to transfer the demands off Durban Heights WTP and onto the Western Aqueduct. However, until the uMWP has been commissioned, Durban Heights WTP will need to continue to supply Pinetown with 50 Mℓ/day and a minimum pumping of 30 Mℓ/day to Ntuzuma. No significant reduction in sales has occurred since the Western Aqueduct was commissioned in 2019. The estimated reduction in demand on Durban Heights was forecast to be approximately 20 Mℓ/day.

The approximate 20 Mℓ/day that was to be freed up would have been utilised to meet the increasing demands of other nodes along the extension of the Northern Aqueduct. These include the demands of new housing developments in the Verulam/Tonga area, Grange and that of the proposed Dube TradePort.

An analysis of historical production for the Durban Heights WTP (November 2022 to October 2023) is presented in **Figure 7.43**, and shows that for 97.8% of the time the WTP was being operated above the optimal operating capacity (80% of design capacity) and 0.8% of the time the WTP was operated at above design capacity. The previous year Durban Heights WTP was operating above the optimal operating capacity for 83.2% of the time. This indicates an increase in demand from the WTP over the last year and may be attributed to the recommissioning of Aqueducts 1 and 2 that were damaged during the April 2022 floods, as well as the completion of Reservoir 3 refurbishment during December 2022.

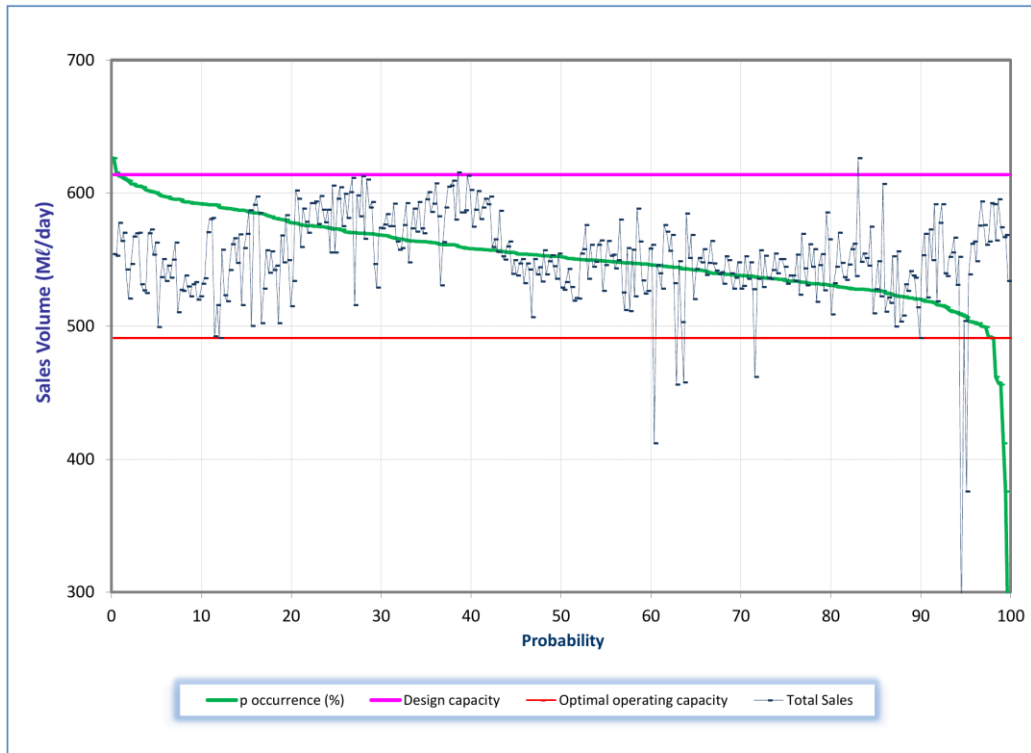

Figure 7.43 Analysis of historical production at Durban Heights WTP from November 2022 to October 2023.

Current raw water abstractions from the uMngeni System exceed the Water Use Licence, which is potentially a criminal offense; in this regard a Notice of Intent to issue a Directive was received from DWS, dated 18 July 2023 for contravening the conditions of the Water Use Licence (WUL). In light of the DWS intent to issue a Directive, the proposed developments and associated demand within the EWS area of supply were **not** discussed with the municipality during August 2023. EWS therefore **did not** present their anticipated total demand scenarios. Rather, and to ensure abstractions are equal to or less than the WUL amount, a decrease in sales forecast for the ensuing years were mutually agreed. A year-on-year decrease in demand of 10.2% is anticipated. Thereafter, a 0.0% increase per annum is estimated for the following years and this will give the Municipality the time needed to plan and implement WC/WDM initiatives, which will then reduce the demand in the system. The WC/WDM initiatives explain forecast levelling off trend of the 12-month moving average as illustrated in **Figure 7.44**.

Demand for the 2022/2023 financial year was 550.0 Mℓ/day. An increase of 27.7 Mℓ/day or 5.3% was recorded over the year.

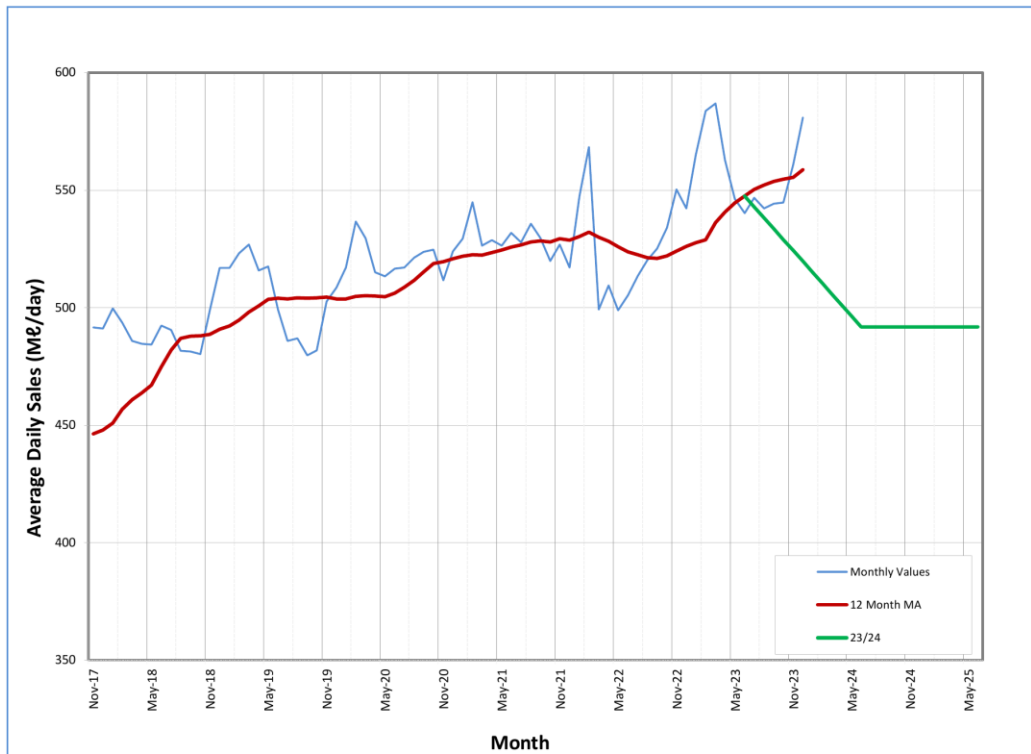

Figure 7.44 Historical demand curve for Durban Heights WTP.

(j) Wiggins Water Treatment Plant

Wiggins WTP supplies the Amanzimtoti/KwaMakuta areas located in the southern portion of eThekweni Municipality. Due to water resource constraints at Nungwane Dam (**Section 11.2.3 (a)**) and the limited capacity of Amanzimtoti WTP, it is necessary to augment the supply to areas downstream of the Amanzimtoti WTP with flows from Wiggins WTP via the South Coast Augmentation (SCA) Pipeline. This will be required until such time as a new regional bulk water supply system is developed on the lower reaches of the uMkhomazi River (**Section 11.7.3 (d)**). In the interim, the Wiggins WTP sub-system should have sufficient treatment and distribution capacity to meet the short and medium-term demands of Amanzimtoti and the South Coast Pipeline (SCP).

Figure 7.45 shows the current configuration of the existing SCA pumped supply infrastructure linking the Wiggins WTP sub-system to Amanzimtoti WTP. This system has certain operational capacity constraints that still have to be rectified to ensure that the Wiggins WTP system continues as the point of supply for Amanzimtoti and the SCP in the future.

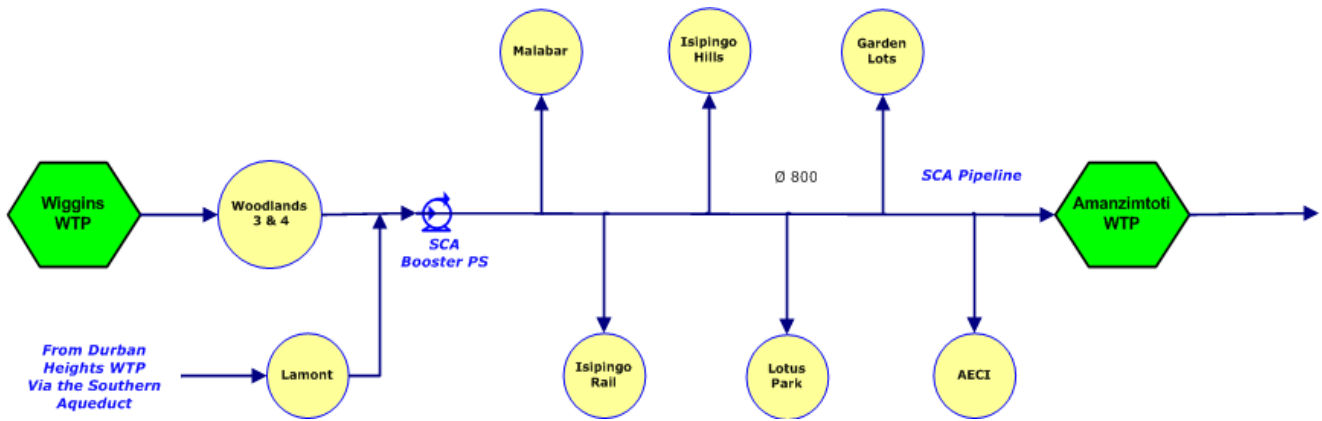

Figure 7.45 Extent of the South Coast Augmentation Scheme.

The South Coast Augmentation Booster Pump Station was commissioned in December 2013 and serves as a medium-term infrastructure development strategy to meet current and projected demands off the SCA Pipeline up to the year 2020.

An analysis of historical production at the Wiggins WTP (November 2022 to October 2023) is presented in **Figure 7.46** and shows that for 95.7% of the time the WTP was being operated above the optimal operating capacity (80% of design capacity) and 3.0% of the time the WTP was operated at above design capacity.

Demands from Wiggins WTP over the 2022/2023 financial year remained ‘constant’, the marginal increase in sales to eThekweni Municipality may be attributed to challenges in the SCA Pipeline supply to Amanzimtoti WTP, with load-shedding having an effect on the municipality water supply systems. A slight increase in demand of 3.1 Mℓ/day (1.0%) when compared with the prior year demand growth (**Figure 7.49**). The previous year Wiggins WTP was operating above the optimal operating capacity for 83.1% of the time.

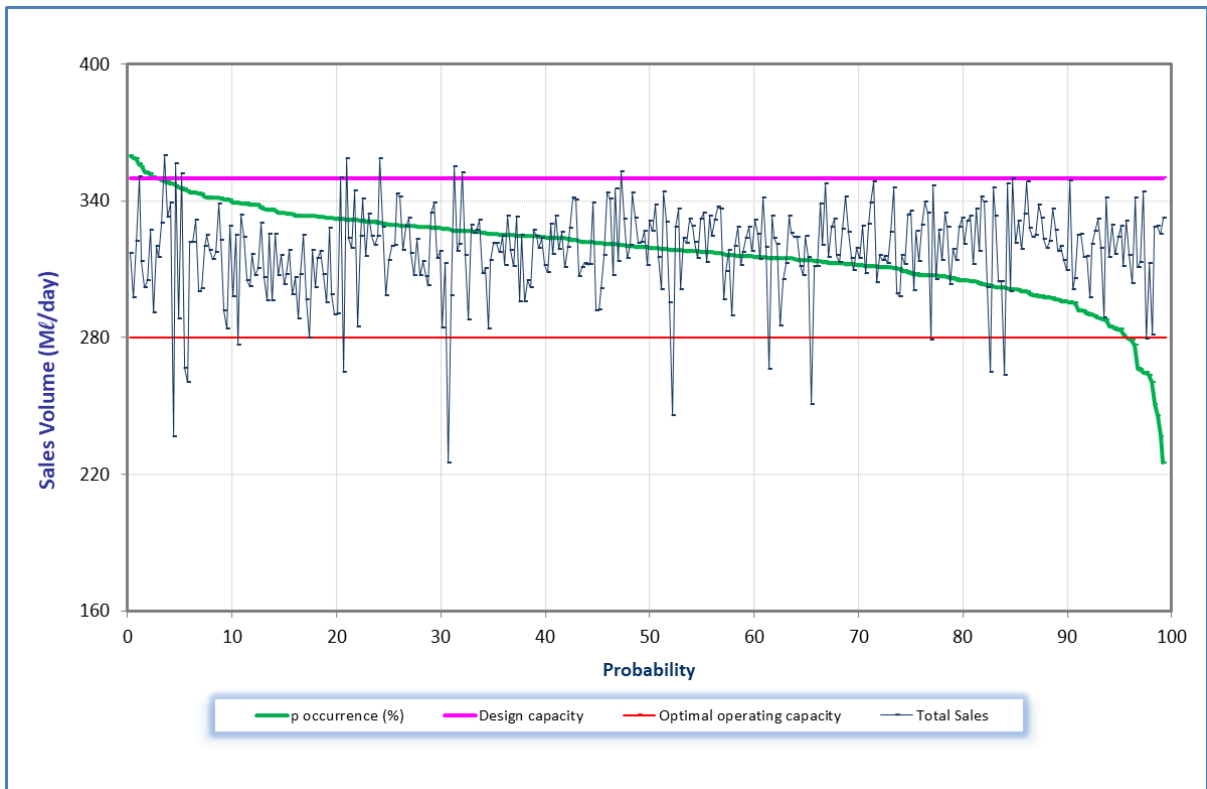

Figure 7.46 Analysis of historical production at Wiggins WTP from November 2022 to October 2023.

The historical and projected water demand from the Wiggins WTP is presented in **Figure 7.47**.

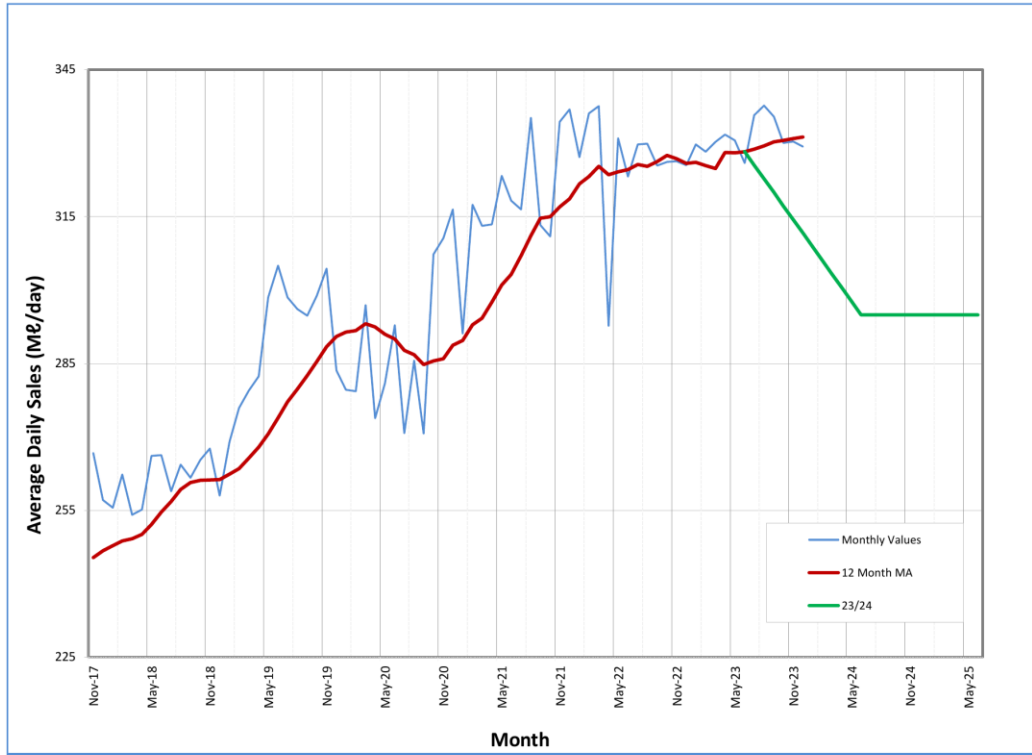

Figure 7.47 Historical demand curve for Wiggins WTP.

(k) Maphephethwa Water Treatment Plant

Maphephethwa WTP (**Figure 7.48**) was originally commissioned as a rural scheme under a turnkey contract. The works is located in the Inanda Dam area and draws water off one of the Nagle Dam raw water aqueducts supplying Durban Heights WTP. The raw water is filtered through a set of four slow sand filters. The filtered water is chlorinated and supplied into a 1 Mℓ on-site storage/distribution reservoir. The original works had slow sand filters with a treatment capacity of 0.75 Mℓ/day.

The works was upgraded to a design capacity of 5 Mℓ/day in 2014. The WTP is currently operated at 4.3 Mℓ/day. Raw water to the works is drawn from Nagle Aqueduct No. 2, which delivers water to Durban Heights WTP, via a 160 mm internal diameter PVC pipeline. The off-take point of the Aqueduct is located 260 m from the works. The raw water supply pipeline to the WTP is fitted with a pre-chlorination unit, flow meter and a flow control valve.

An analysis of historical production at the Maphephethwa WTP (November 2022 to October 2023) is presented in **Figure 7.49**. It shows that for 73.9% of the time, the WTP was being operated above the optimal operating capacity (80% of design capacity) and 1.7% of the time the WTP was operated at above design capacity (based on the upgraded capacity of the plant).

Figure 7.50 shows that the demand on this WTP remained 'constant' during 2022/2023. The works currently produces an average of 4.1 Mℓ/day (as at the end of October 2023). It is envisaged that the demand will decrease to conform with the DWS Notice and ensure that water abstractions adhere to the WUL conditions during 2024 (**Figure 7.50**).

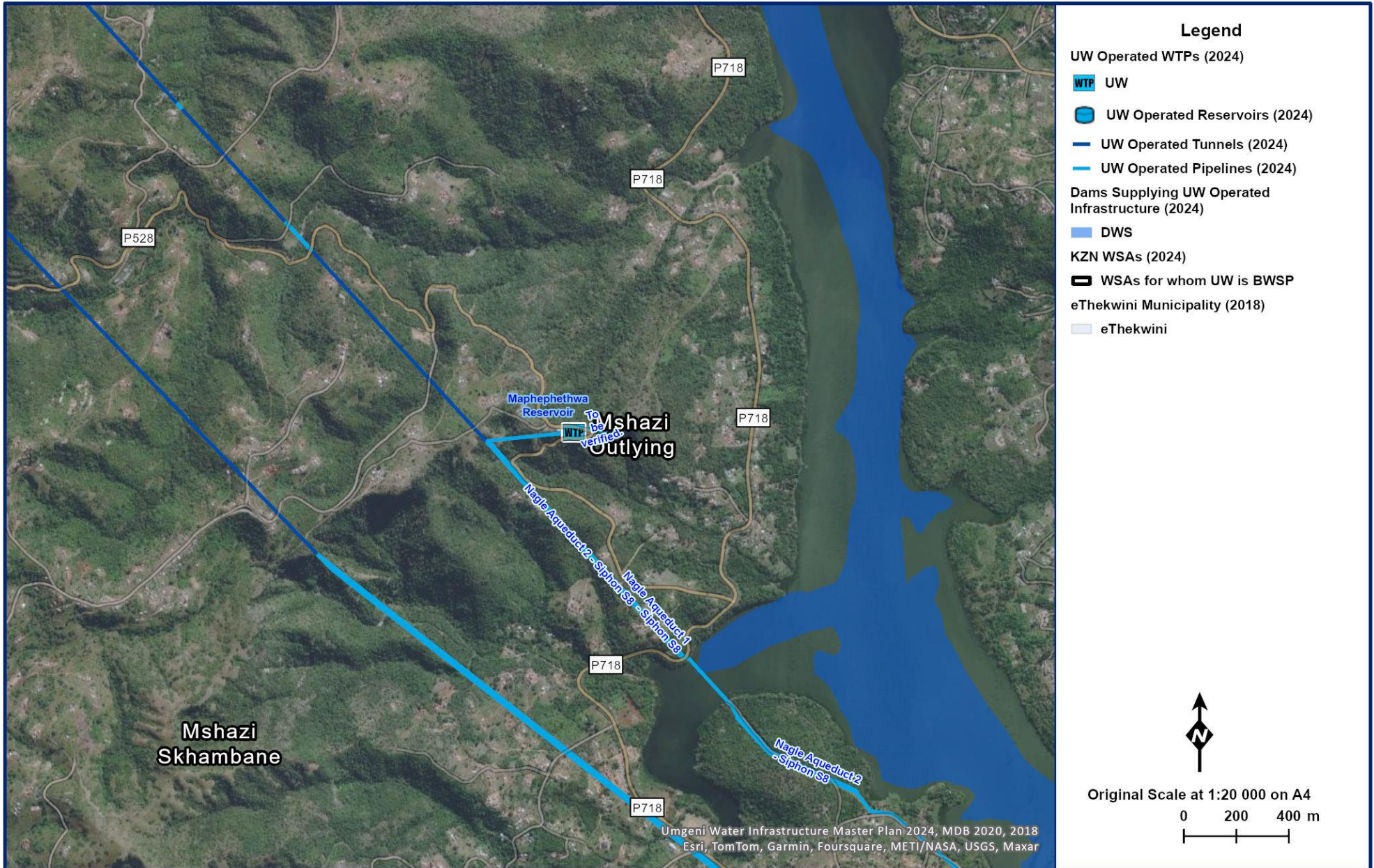

Figure 7.48 Maphephethwa Water Treatment Plant.

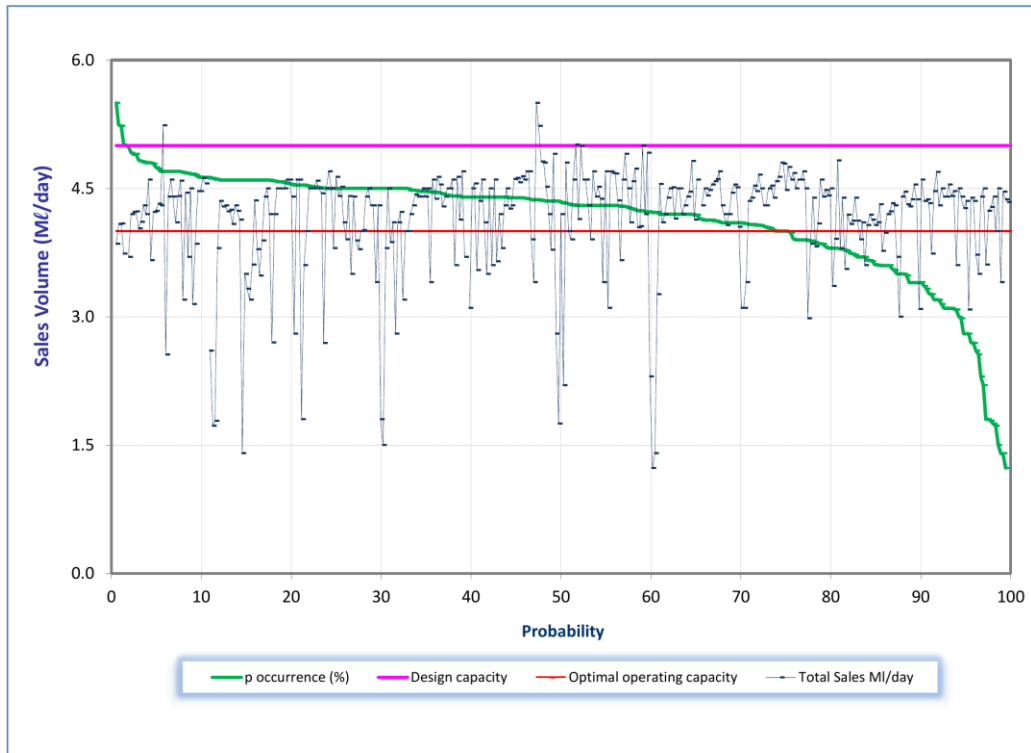

Figure 7.49 Analysis of historical production at Maphephethwa WTP from November 2022 to October 2023.

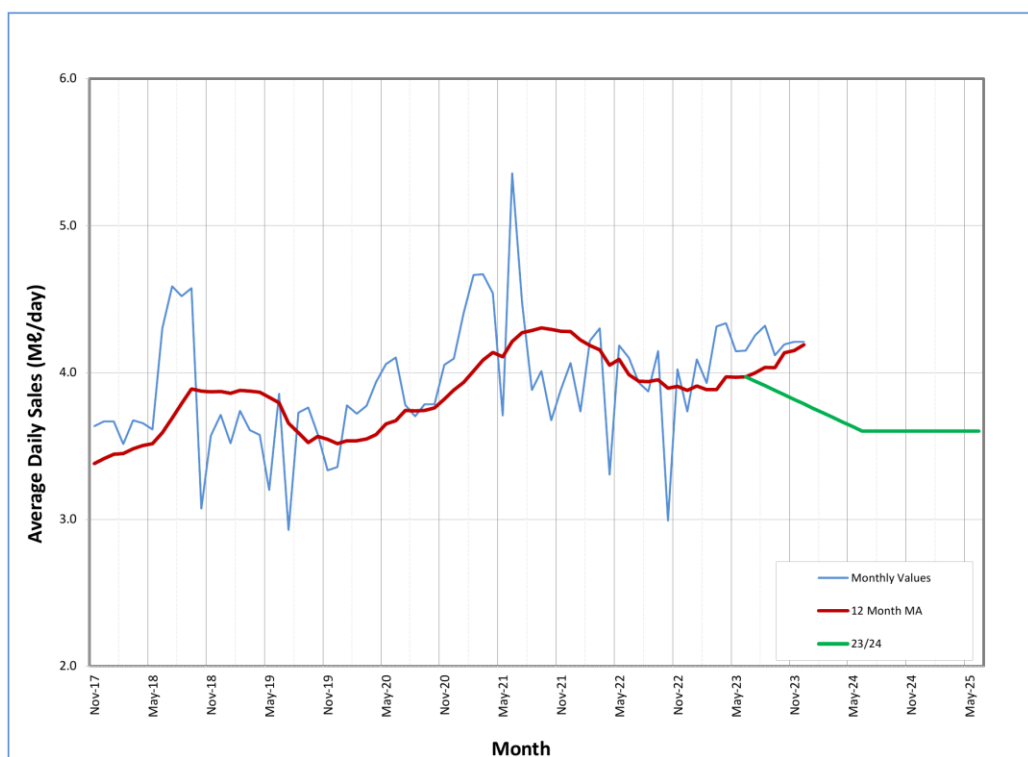

Figure 7.50 Historical demand curve and projections for Maphephethwa WTP.

7.4 Water Balance/Availability

The current uMngeni System can be considered as a “stressed” catchment and **Table 7.49** indicates yields for the levels of assurance that are below levels that EWS require.

Table 7.49 Yield Information for uMngeni System.

Stochastic Yield (1 in 5 years risk of failure)		Stochastic Yield (1 in 10 years risk of failure)		Stochastic Yield (1 in 20 years' risk of failure)	
million m ³ /annum	Mℓ/day	million m ³ /annum	Mℓ/day	million m ³ /annum	Mℓ/day
510.0	1397.3	497.0	1361.6	470.0	1287.7

A graphical representation of the 1:100-year yield information (worst drought in 100 years) for the uMngeni System is presented in Figure 7.54. The graph also shows the yield of the proposed Smithfield Dam on the Mkhomazi River, which is 220 million m³/a. The projected water demand line for the uMngeni System is shown on the graph and these demands are based on 0 % growth until the next augmentation, i.e., Smithfield Dam.

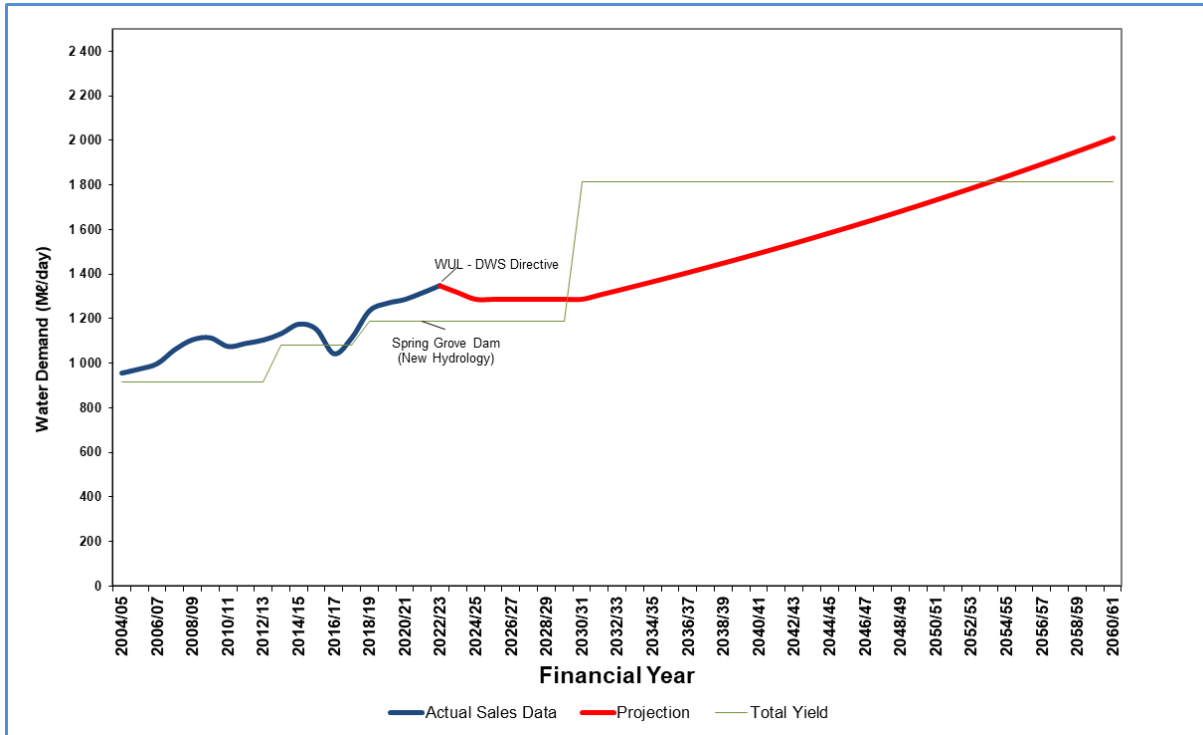

Figure 7.54 uMngeni System balance.

7.5 Recommendations for the uMngeni System

7.5.1 System Components

(a) Mooi/uMngeni Water Resource Region

In evaluating the long-term water security of the uMngeni system, water resources analyses were undertaken by the DWS Reconciliation Strategy Study (DWA 2009). Analyses indicate that further augmentation of the system is required. In this regard, options being considered currently include the uMkhomazi-uMngeni Transfer Scheme (known as the uMkhomazi Water Project; **Section 7.5.2 (a)**), the reuse of treated effluent, and seawater desalination. Yields of the proposed infrastructure (uMkhomazi Water Project) are listed in **Table 7.51**.

(b) uMkhomazi Water Resource Region

The current water resources of the uMngeni System are insufficient to meet the long-term water demands of its own system. Past investigations have indicated that, possibly, the most suitable long-term solution would be to develop a scheme that transfers raw water from the still undeveloped uMkhomazi River to the uMngeni Catchment. Water resources development options on the uMkhomazi River (**Figure 7.51**) have been investigated with a number of potential sites and transfer options being considered. The recommended scheme, known as the uMkhomazi Water Project (uMWP) (**Section 7.5.2 (a)**) will comprise of two phases.

The first phase (uMWP-1) will consist of the once-off constructed 251 million m³, 58 m high Smithfield Dam (**Table 7.50** and **Figure 7.52**) on the uMkhomazi River near Richmond from where water would gravity feed through a 32 km, 3.5 m diameter transfer tunnel. Treated water would be transferred from a 600 Mℓ/day WTP, near the outlet of the tunnel, through potable water pipelines to an appropriate delivery node within the uMngeni catchment (**Section 7.5.2 (a)**). DWS anticipates that the uMWP-1 will be implemented in 2028. The yields of the proposed water resource infrastructure for the uMkhomazi Region are listed in **Table 7.50** and **Table 7.51**.

The second phase (uMWP-2) will comprise the construction of a large dam at Impendle further upstream on the uMkhomazi River. Once in place, water would be released from the Impendle Dam down the uMkhomazi River for abstraction and transfer at Smithfield Dam (**Table 7.50**). The Impendle Dam could be built either in two phases or as a once-off constructed scheme component. The uMWP-2 would only be implemented at a future date when needed.

The Greater Bulwer-Donnybrook Regional Water Supply Scheme is currently in construction and is due to be completed in 2021. This scheme intends using both the proposed Stephen Dlamini and existing Comrie dams as water sources. The Stephen Dlamini Dam, situated on the Luhane River will yield 8 Mℓ/day and Comrie Dam 3.7 Mℓ/day. The combination of these two dams is unlikely to be sufficient for the current scheme footprint. It is recommended that a raw water transfer scheme from the Pholela River be investigated in detail to augment this scheme.

Figure 7.51 Proposed water resource infrastructure in the Mkhomazi Region (KZN DoT 2011; MDB 2016; UMngeni-uThukela Water 2017; WR2012).



Figure 7.52 Artistic impression of Smithfield Dam.

Table 7.50 Proposed water resource infrastructure for the Mkhomazi Region.

Impoundment	River	Capacity (million m ³)	Yield (million m ³ /year)	Stochastic Yield (million m ³ /year)
			Historical	1:100
Smithfield Dam	uMkhomazi	226	172 (471 Mℓ/day)	220 (602 Mℓ/day)
Impendle Dam	uMkhomazi	270	204 (559 Mℓ/day)	228 (625 Mℓ/day)
Ngwadini Dam	uMkhomazi (Off-channel)	10	Not Available	34 (93 Mℓ/day)
Stephen Dlamini Dam	Luhane	9.8	Not Available	3.4* (9.3 Mℓ/day)

excl. Ecological reserve

Previous studies were reviewed regarding the Lower uMkhomazi Off-Channel Storage Dam (Ngwadini Dam) option to provide a reliable water supply to the South Coast area. The construction of Phase 1 – Ngwadini Off Channel Storage Dam is currently in progress. This phase comprises of Ngwadini Abstraction Works, Goodenough Weir and Abstraction Works, Desilting structures, Raw water storage reservoir, 1km Rising main and 7 km raw water gravity main. Phase 2 will comprise of the Water Treatment Works; Gravity Bulk Potable water main; and Command Reservoir.

The current total demand for the South Coast is 88 Mℓ/day with Ugu District Municipality’s current demand being approximately 20 Mℓ/day and eThekweni Municipality’s demand being approximately 68 Mℓ/day. The yield of the uMkhomazi River, with Sappi’s allocation and the Reserve supplied, is 93 Mℓ/day. Raw water from the Ngwadini Off Channel Storage Dam will be transferred via a bulk pipeline to a new Water Treatment Plant, a storage reservoir and finally to the South Coast Pipeline (SCP).

DWA (2013) undertook a detailed hydrological assessment on the uMkhomazi and Upper uMlaza River Catchments with the purpose of updating and extend the simulations for the area. The results from the hydrology assessment were used in a number of yield assessment scenarios to determine the impact of releasing water from Smithfield Dam to augment Ngwadini Dam. The scenarios and impacts on yield are shown in **Table 7.51** .

Table 7.51 Yields for proposed water resource infrastructure for Mkhomazi Region (DWA 2013).

Scenario	Time Slice	Support Releases	Ngwadini Dam Yield/Target (1:100)		Smithfield Dam Yield (1:100)	
		(Smithfield to Ngwadini)	Mℓ/day	Million m ³ /annum	Mℓ/day	Million m ³ /annum
Ngwadini Dam	2012	None	93	34	-	-
Ngwadini & Smithfield	2050	None	66	24	602	220
Ngwadini & Smithfield	2050	Yes	70	26	600	219
Ngwadini & Smithfield	2050	Yes	95	35	586	214
Ngwadini & Smithfield	2050	Yes	150	55	537	196

(c) Overview of Recommendations for the Upper uMngeni System

Figure 7.53, Figure 7.54, Figure 7.55, Figure 7.56 and Figure 7.57 illustrate schematically the Upper uMngeni System in its current configuration and how it will need to be upgraded over the next 30 years to accommodate the future growth in water demands. This Section should be read in conjunction with these Figures.

- Construction of Phase 1 of the uMkhomazi Water Project; and
- Decommissioning of the '53 Pipeline.

Other infrastructure upgrades and additions that will be required over the next 30 years include:

- Increase the capacity of the Mills Falls to Howick West Supply System

- Augmentation of the Vulindlela BWSS;
- Whilst the Clarendon and Blackridge Reservoirs should be upgraded, it is recommended that this requirement be transferred to The Msunduzi Municipality as the additional 48-hour emergency storage requirement is a WSA responsibility.
- Augmentation of the Umbumbulu system, construction of a new pump station and pipeline.

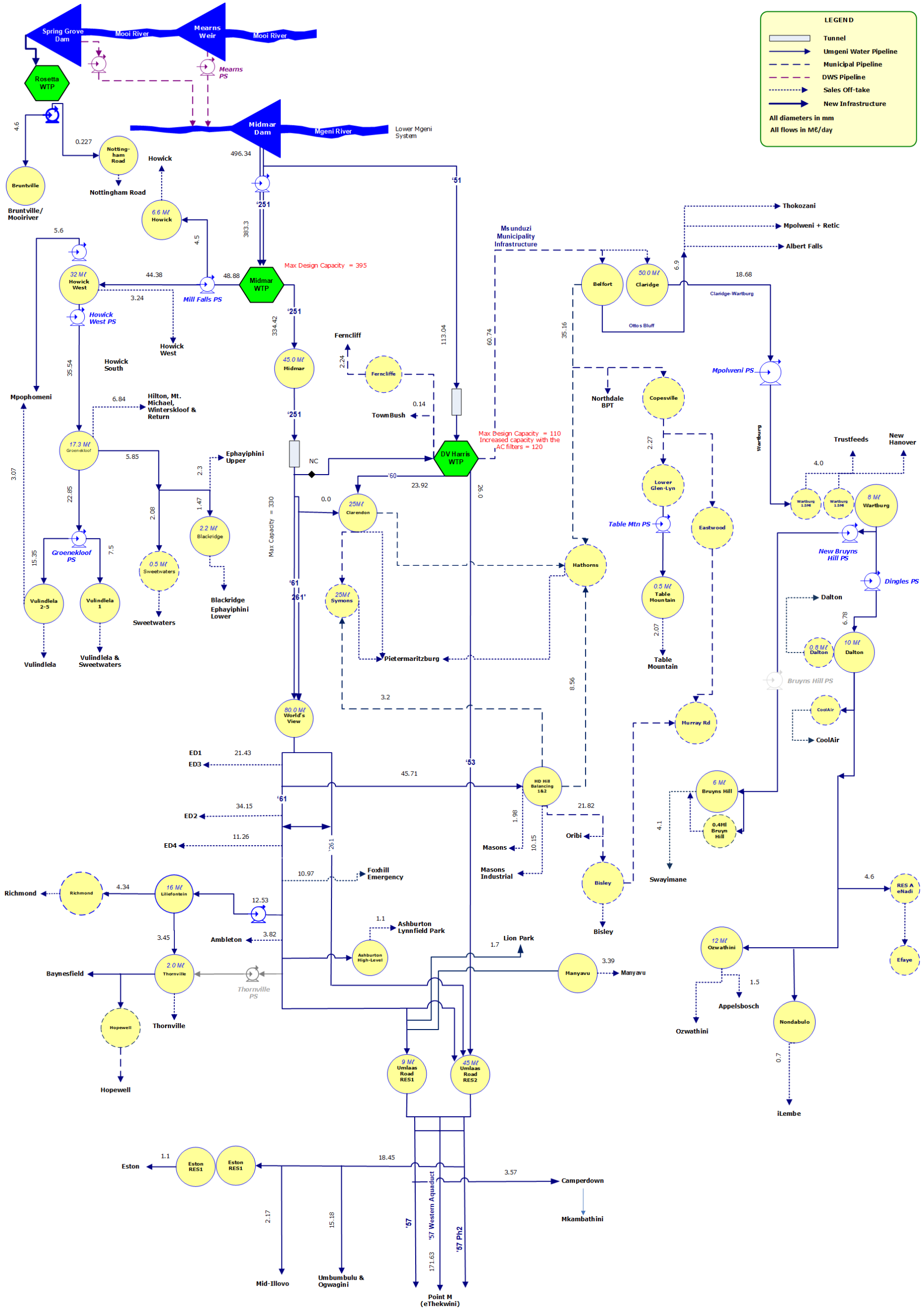

Figure 7.53 Demand on the Upper uMgeni System as at October 2023.

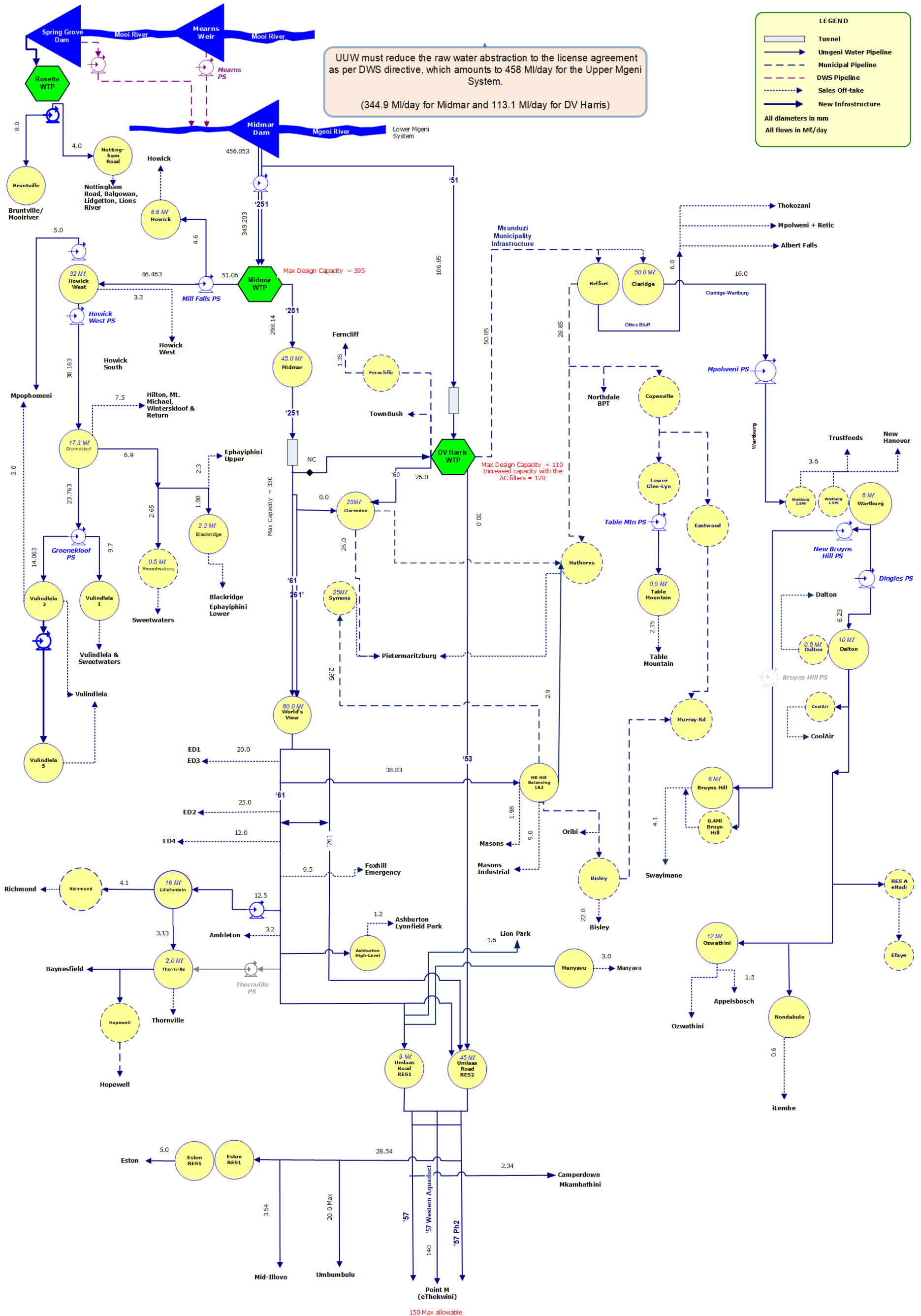

Figure 7.54 Five year demand projection for the Upper uMgeni System.

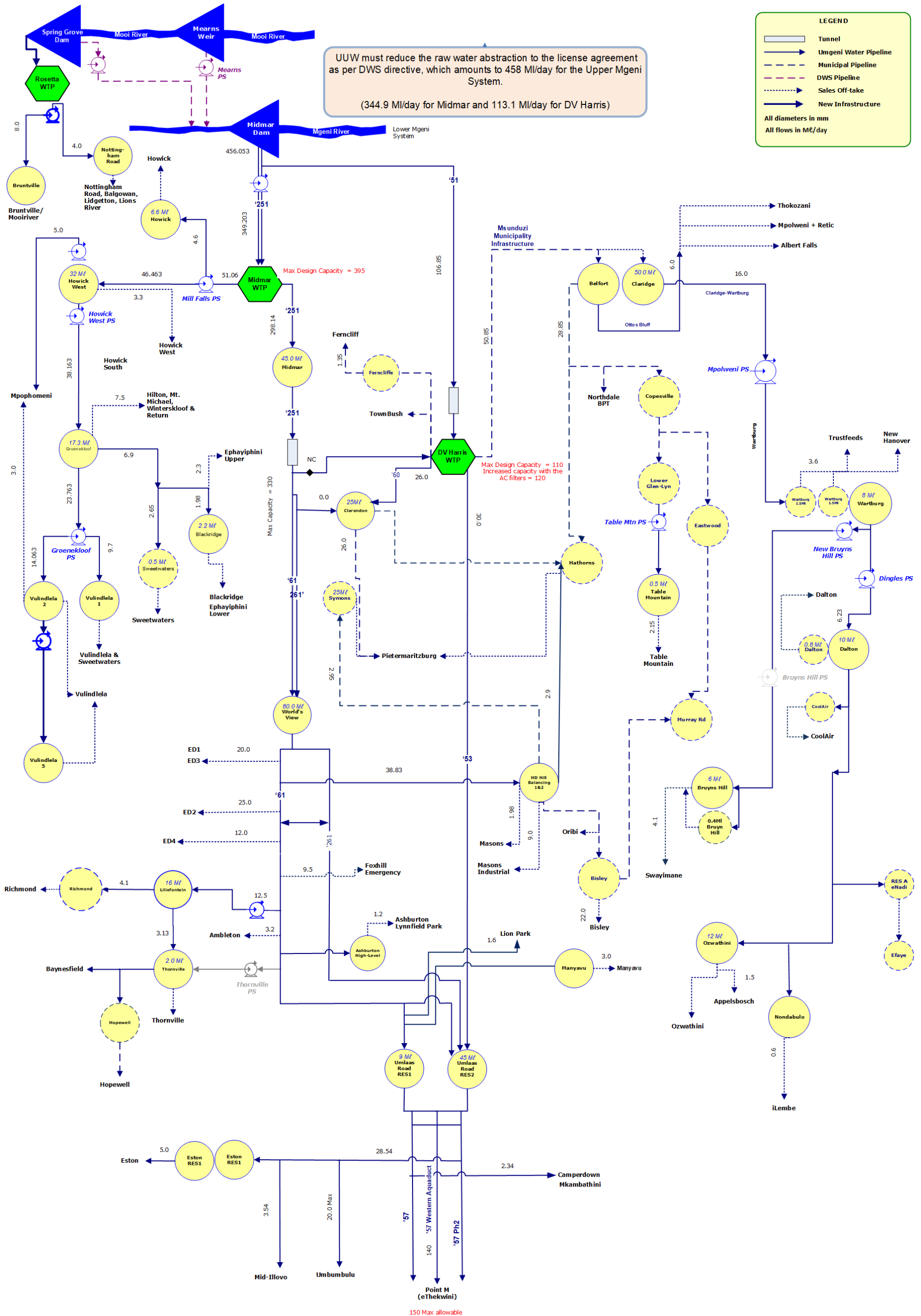

Figure 7.55 Ten year demand projection for the Upper uMgeni System.

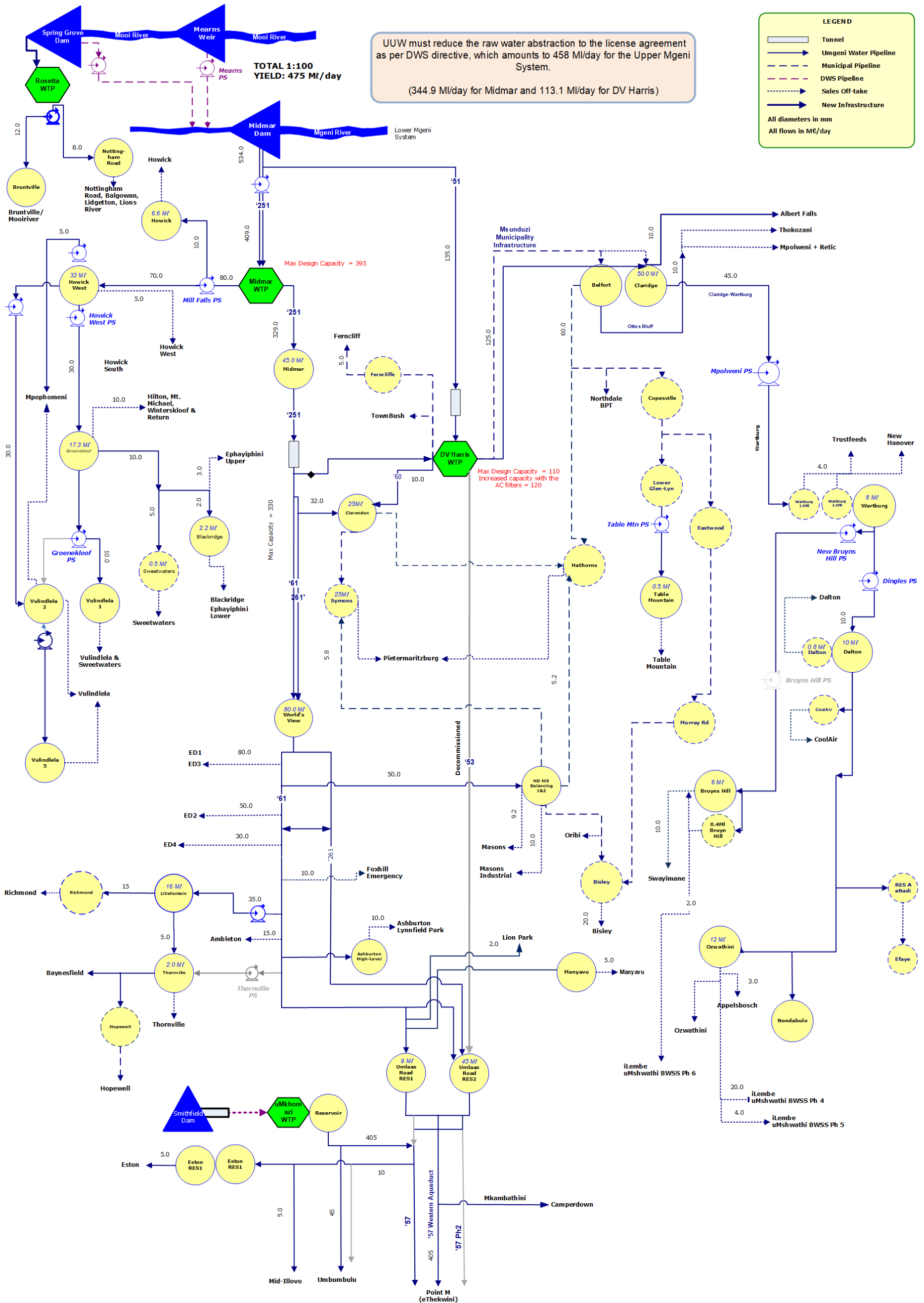

Figure 7.57 Thirty year demand projection for the Upper uMgeni System.

(d) Midmar Water Treatment Plant

The Western Aqueduct was commissioned in 2020/2021. The Midmar WTP has been upgraded from its treatment capacity of 250 Mℓ/day to 375 Mℓ/day (2018) to accommodate the new demand on the Western Aqueduct. Midmar WTP and D.V. Harris WTP, combined, can now supply 485 Mℓ/day. This is slightly above the 99% assured yield of Midmar Dam of 475 Mℓ/day (173.7 million m³/annum) when supported by the MMTS.

(e) Howick-North Sub-System

The Howick Reservoir Complex will have to supply newly developed areas to the north of Howick. This high-level reservoir serves as a distribution reservoir that should have 48 hours of storage. The total storage is currently 6.6 Mℓ/day following the addition of a 6.5 Mℓ reservoir in October 2014 and the total current demand is 4.6 Mℓ/day.

(f) Howick-West Sub-System

(i) Mills Falls to Howick - West Reservoir

The rapid growth in demand of the Vulindlela Supply System impacts on the capacity of the upstream supply systems, especially the Mills Falls to Howick West Supply System. This system must be augmented to meet the 20-year demand of 85 Mℓ/day, starting in 2025.

(ii) Howick - West Reservoir to Groenekloof Reservoir

Storage at Howick-West Reservoir was increased by 16 Mℓ (16 Mℓ reservoir currently being commissioned) to bring the total storage to 32.5 Mℓ (**Section 7.5.2 (d)**). This would then adequately serve as a distribution reservoir until 2030. A new 400 mm diameter pipeline, dedicated to serve the Mpophomeni area, will be required by UMDM once the new Khayalisha housing development is constructed. The existing 250 mm diameter pipeline will then become a backfeed from the Mpophomeni Reservoir.

(iii) Vulindlela BWSS

The current demand on the Vulindlela BWSS is approximately 22.2 Mℓ/day and the projected demand is 63.1 Mℓ/day in 2050.

The existing capacity of the system is capable of serving the current demand; although, future growth will exceed the system capacity.

Extensive hydraulic analyses were conducted to optimise the hydraulic efficiency of the Vulindlela BWSS. The results of the hydraulic analyses indicated that the following infrastructure requirements, which are currently in detailed design stage (**Section 7.5.2 (h)**), are needed:

- Construct a new pump station at Howick West Reservoir Complex by installing 3 x 22 Mℓ/day pump sets (2 x operating and 1 x standby).
- Construct an 800 mm diameter pipeline of 11 km in length from Howick West Pump Station to Reservoir 2.
- Construct a Pump Station at Reservoir 2 consisting of 2 x 18 Mℓ/day pump sets (1 x operating and 1 x standby).

- Construct one 15 Mℓ Reservoir (25 Mℓ required in total) at the Reservoir 2 site as additional storage to the existing 10 Mℓ reservoir.
- Construct a back-feed pipeline of 200mm diameter with a length of 6 km, from Reservoir 5 to supply Reservoir 3 and Reservoir 4.

(g) Midmar WTP to Umlaas Road Sub-System

(i) '61 Pipeline: World's View Reservoir to ED4

This section of infrastructure allows for the maximum of 330 Ml/day that the tunnels can deliver. No further infrastructure is required.

(ii) Thornville/Hopewell Supply

Thornville Reservoir can be supplied from both the Richmond pipeline and the existing Thornville Pump Station. The rising main from the '61 Pipeline to Thornville, operated as a back-feed gravity main when the Richmond BWSS was commissioned in 2015, supplying water to Thornville from the Richmond Pipeline. It was required to revert to the old operational philosophy of pumping from the Thornville pumpstation to serve the Thornville, Hopewell and Baynesfield areas due to the increase in demand of the Richmond BWSS.

(iii) '53 Pipeline: D. V. Harris WTP to Umlaas Road Reservoir

This pipeline needs to remain operational until such time as the uMWP is commissioned. Thereafter it is recommended that it be decommissioned. In the interim, caution should be taken not to exceed the "safe load carrying capacity" of 35 Mℓ/day. The operational philosophy for the '53 pipeline, allows a maximum of 30 Mℓ/day.

(h) Umlaas Road Sub-System

An analysis of the Umlaas Road Reservoir Complex showed that the augmentation to the '61 Pipeline system resulted in little or no stress on the reservoirs. This coupled with the fact that eThekweni Municipality have indicated that they have sufficient storage in their system, and that they do not wish uMngeni-uThukela Water to augment the Umlaas Road storage, means that there is no planned augmentation of storage at Umlaas Road. Additional storage will be constructed as part of the uMWP.

(i) Eston/Umbumbulu Pipeline

The capacity of this pipeline is restricted to 15 Mℓ/day due to the ground level profile along the pipeline route. The flow is restricted to ensure that the hydraulic grade line is at least 20 m above a high point at Stoney Ridge. A booster pump station and a 900 mm diameter steel pipeline has been constructed to increase the flow through this pipeline to a maximum 22 Mℓ/day (**Section 8.5.2 (e)**). The projected growth in demand is envisaged to peak at 50 Mℓ/day by the year 2047. To ensure the sustainability of supply, uMngeni-uThukelaWater will initiate a feasibility study to augment the existing supply system with a new pipeline.

(i) Wartburg Sub-System

New bulk supply infrastructure has been constructed to meet the projected demands of both existing consumers as well as the areas of greater Efaye, Ozwathini and Southern Ndwedwe (**Section 7.5.2 (f)** and **Section 12.5.2 (a)**).

The infrastructure is as follows:

- 26 km, 850 mm diameter pipeline from Claridge to Wartburg (construction completed in November 2015) including a 1.25 MW booster pump station (March 2018) and 8 Mℓ Reservoir at Wartburg (construction completed in July 2017).
- 15.5 km 700 mm diameter pipeline from Wartburg to Dalton including a 1.35 MW booster pump station and 10 Mℓ Reservoir at Dalton (November 2017).
- 10.7 km 750 mm diameter pipeline from Dalton to Fawn Leas (April 2018).
- 21.7 km long 700 mm diameter pipeline (June 2017) from Fawn Leas to a new 7 Mℓ reservoir (December 2018) at Ozwathini including a 0.5 MW booster pump station at Dalton (June 2017).
- 14.5 km long, 350 mm diameter pipeline from Fawn Leas to an existing reservoir at Nadi Mvoti (in Efaye) (June 2017).

(ii) Wartburg Reservoir to Bruyns Hill Reservoir

The 260 mm diameter Bruyns Hill pipeline between Bruyns Hill Pump Station and Bruyns Hill Reservoir was commissioned in 2012. The pipeline between Wartburg Reservoir and the existing Bruyns Hill pump station has been upgraded (**Section 7.5.2 (g)**). The existing pipeline system can only supply, under ideal conditions, a maximum of 6.4 Mℓ/day at a velocity of 1.5 m/s. This will not meet the ultimate demand of the area of supply. The Wartburg to Bruyns Hill Pipeline project will provide adequate supply to current and future supply areas and will eliminate non-supply issues at Swayimane. The project, which is complete, consists of two components:

- Construction of a pipeline from Wartburg Reservoir to Bruyns Hill Pump Station; and
- A pump station near the Wartburg Reservoir site.

(j) Recommendations for Lower uMngeni System

Figure 7.63 illustrates, schematically, the demands on the Lower uMngeni System in its current configuration. Future demands in this area will be supplied by the Lower uMngeni System Water Treatment Plants and through the Western Aqueduct. As such, there are no new infrastructure projects planned for this area at this time. The following project has, however, been recommended to address operational challenges:

- Replacement of the existing pump sets at the Wiggins High Lift Pump Station (HLPS). There is a short-term risk of pump failure (non-supply) as the existing pumps are not appropriate for the current application. The project, currently on hold at completion of Detailed Design Stage, will not alter the capacity of the pump station but aims to satisfy the duty envelope more efficiently from both an energy and maintenance perspective. The HLPS was originally (1996) used as an emergency back-up supply to Durban Heights but has more recently become a permanent supply. In the long term, there is a need to consider system optimisation of the municipality's distribution network considering future demands and reliance on the HLPS.

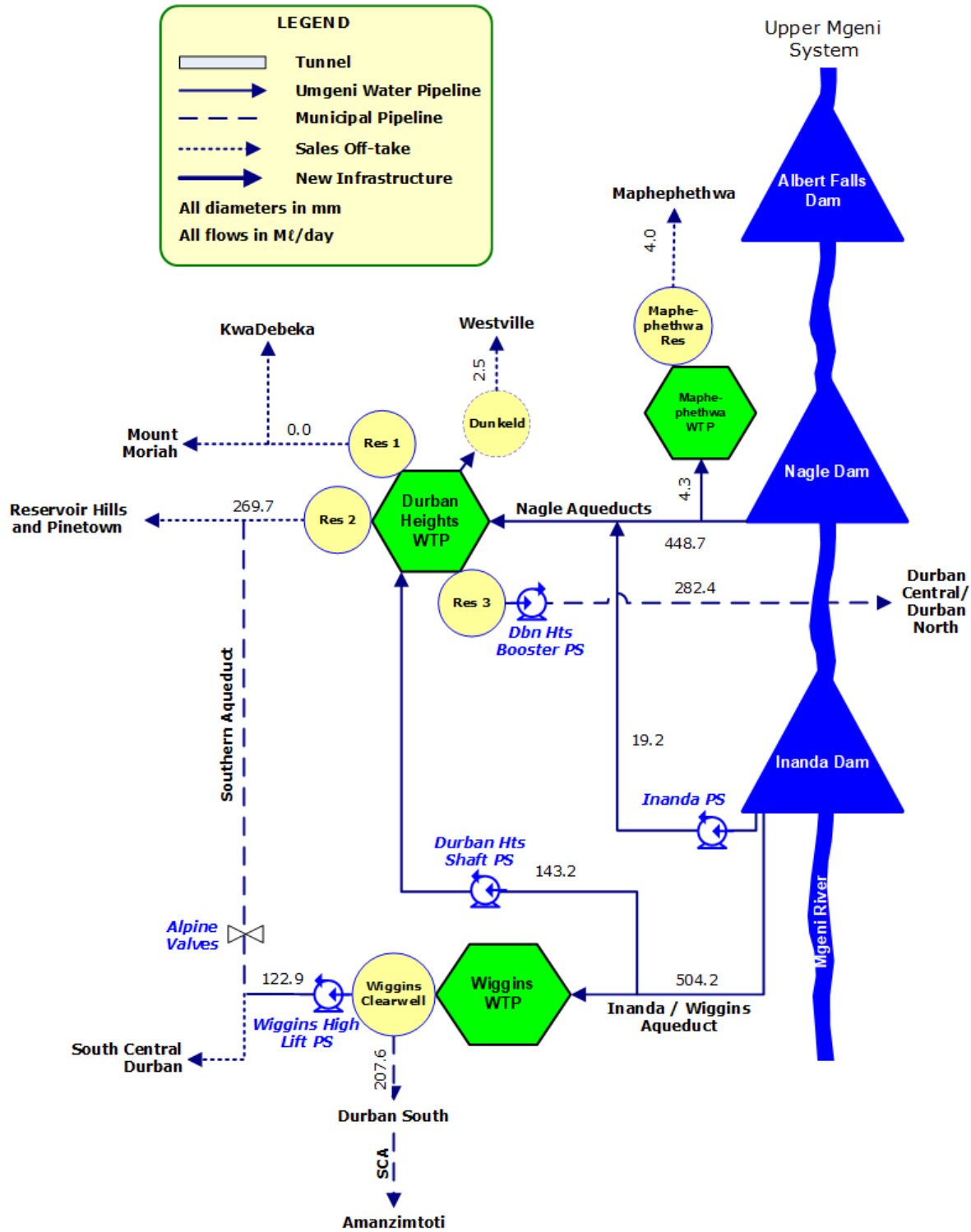

Figure 7.63 Schematic of the Lower uMgeni System.

7.5.2 Projects

(a) uMkhomazi Water Project

Planning No.	114.0
Project No.	UI0530
Project Status	Detailed Feasibility complete.

(i) Project Description

With the commissioning of Phase 2B of the Mooi-uMngeni Transfer Scheme (MMTS-2), the water resources available in the Mooi and uMngeni catchments, to augment the uMngeni System, are now fully utilised (Section 7.2.3 (a)). The MMTS-2 increased the safe assured yield of the uMngeni System to 400 million m³/annum.

Over recent years, eThekweni Municipality has put considerable effort into optimising the operation of its distribution systems that are served by the Lower uMngeni System. Amongst other things, this has led to them implementing new infrastructure in order to undertake a significant load shifting exercise.

eThekweni Municipality's Western Aqueduct project was fully commissioned in 2020/2021, will represent the most significant of these load-shifting operations. The intention is for those areas currently being served under pumping from the Lower uMngeni System (viz. from Durban Heights WTP) to be transferred onto the Upper uMngeni System, and served under gravity from Midmar WTP via the Western Aqueduct (WA). This will result in the full utilisation of the Upper uMngeni resource by 2020. After the implementation of MMTS-2, further water resource developments within the Mooi-uMngeni system are not considered to be beneficial. Further augmentation of the uMngeni System will then be required.

Water resource development on the uMkhomazi River has been identified as the next major project to secure long-term water resources for eThekweni's Western Aqueduct supply zone. During the late 1990's, the then DWAF (now DWS) and uMngeni-uThukela Water jointly commissioned a pre-feasibility study to investigate various options for developing the uMkhomazi River's water resources, such that they could be utilised to augment those of the uMngeni River System.

A two-phased scheme was proposed, and the overall project area is shown in **Figure 7.58**. Phase 1 of the proposed uMkhomazi Water Project (uMWP-1) will involve the construction of Smithfield Dam, located along the central reaches of the uMkhomazi River midway between Lundy's Hill Bridge and Deepdale. Smithfield Dam will be the primary impoundment, whilst for Phase 2, a second dam (Impendle Dam) will be constructed upstream of the Smithfield site (just downstream of the uMkhomazi River/Nzinga River confluence). Phase 2 would only be implemented once the yield of Phase 1 (Smithfield Dam) has been fully utilised.

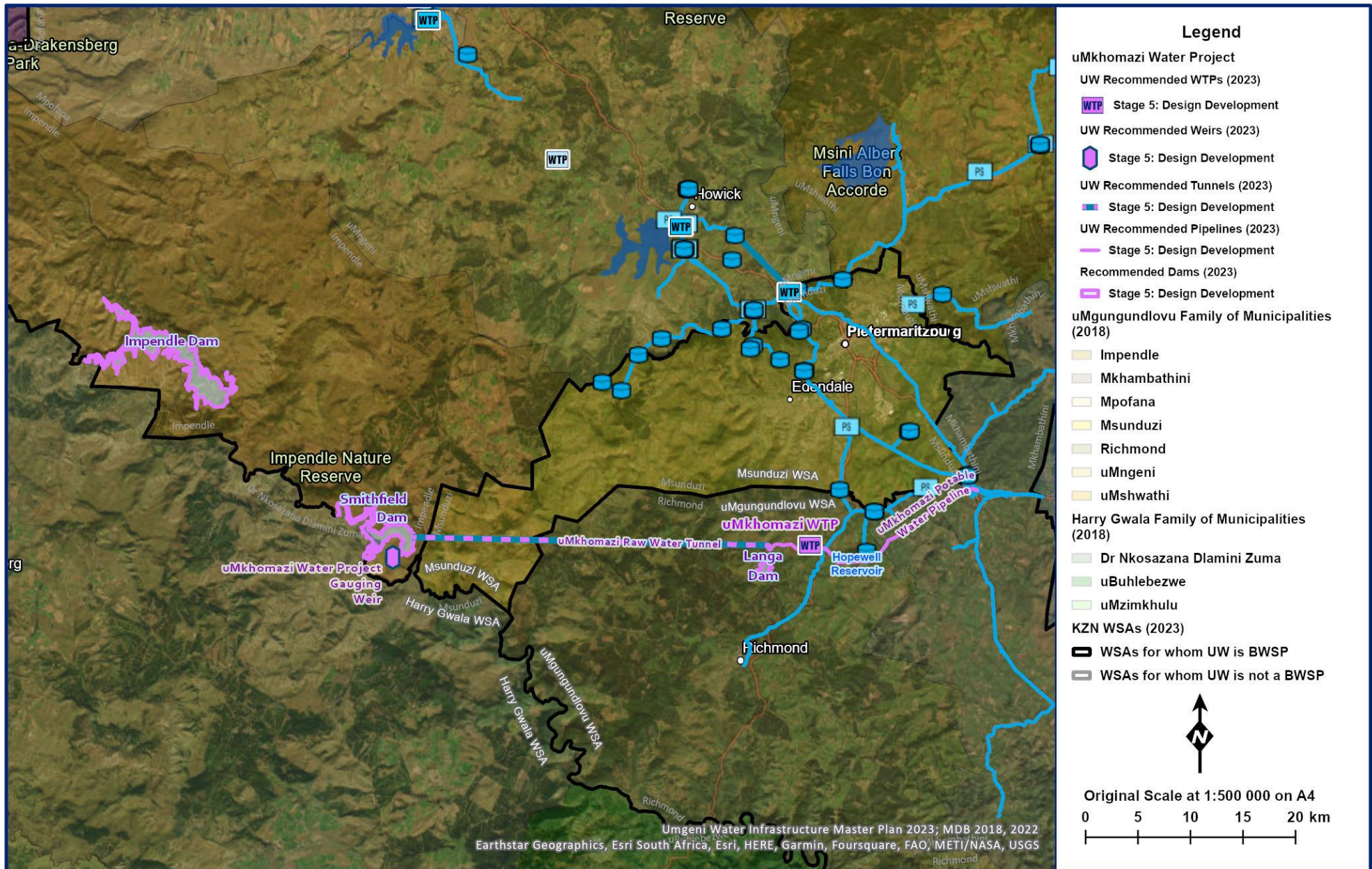

Figure 7.58 uMkhomazi Water Project.

Succinct details of the proposed potable water infrastructure are as follows:

Water treatment plant design: In order to meet the proposed phased increases in demand as well as a requirement to provide support to the uMngeni System, the capacity of the uMWP-1 WTP is proposed to be 500 Ml/day. A further 125 Ml/day phase would be required in 2044. The proposed WTP layout (Figure 7.65) was constrained by the requirement for gravity supply in the overall system between Smithfield Dam and the Umlaas Road tie-in, as well as a requirement to keep the WTP footprint to a minimum. The proposed plant layout combines features of accessible and compact unit process configuration, minimum lengths of interconnecting pipework, minimum volume of excavation and ease of future extension. The recommended WTP processes are pre-chlorination, coagulation/flocculation, high-rate clarifiers, rapid gravity filtration, granular activated carbon (GAC) filtration, final chlorination and sludge treatment.

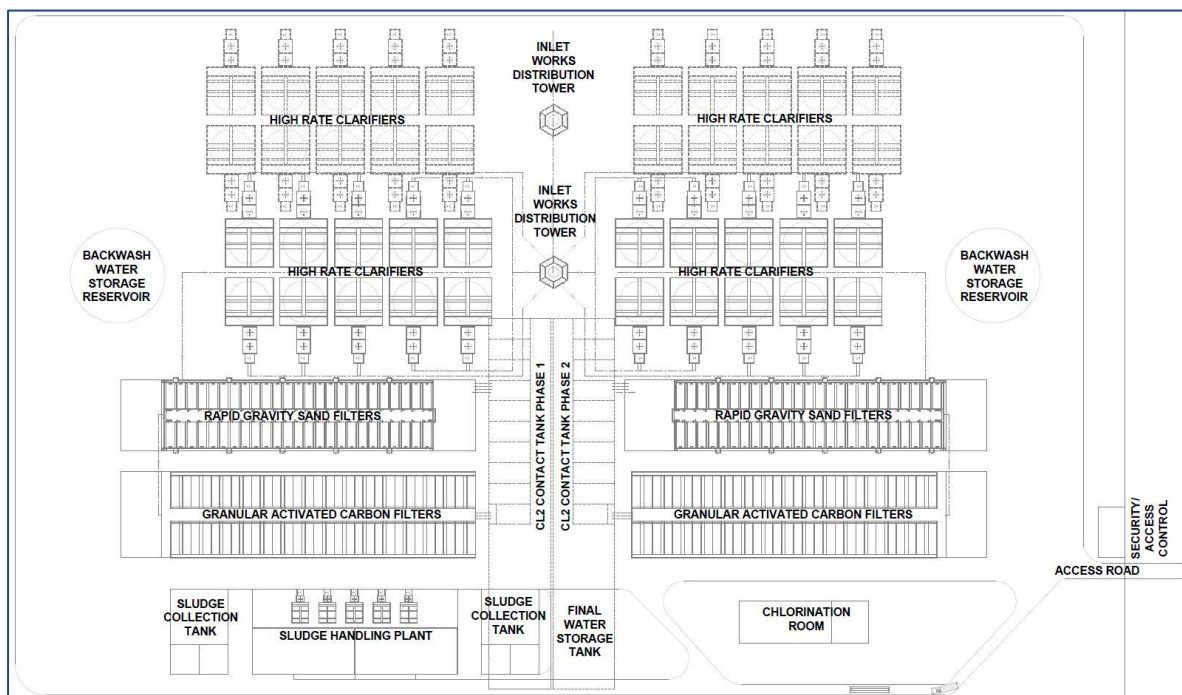

Figure 7.59 Layout of Water Treatment Plant.

Potable water reservoir: The potable water reservoir was sized to accommodate a minimum of six hours of the daily WTP capacity. Based on the WTP phasing discussed above the first 500 Ml/day WTP phase would require 125 Ml of storage, with a further 31.25 Ml/day required when the next 125 Ml/day WTP phase is constructed in 2044, i.e. a total of 156.25 Ml of storage for the uMWP-1. The reservoir for the uMWP-1 would require a footprint of 2.2 hectares. In light of a requirement to keep the WTP footprint to a minimum, it was proposed that potable water storage be constructed beneath various WTW structures.

Potable water pipeline: The potable water pipeline (Figure 7.60) was designed to accommodate an average annual daily demand of 602 Ml/day; equivalent to the 1:100 year yield of the Smithfield. The peak design capacity was 753 Ml/day. Pipelines ranging from 2 820 mm diameter (15.1 km) to 2 540 mm diameter is proposed to convey the peak demand of 753 Ml/day.

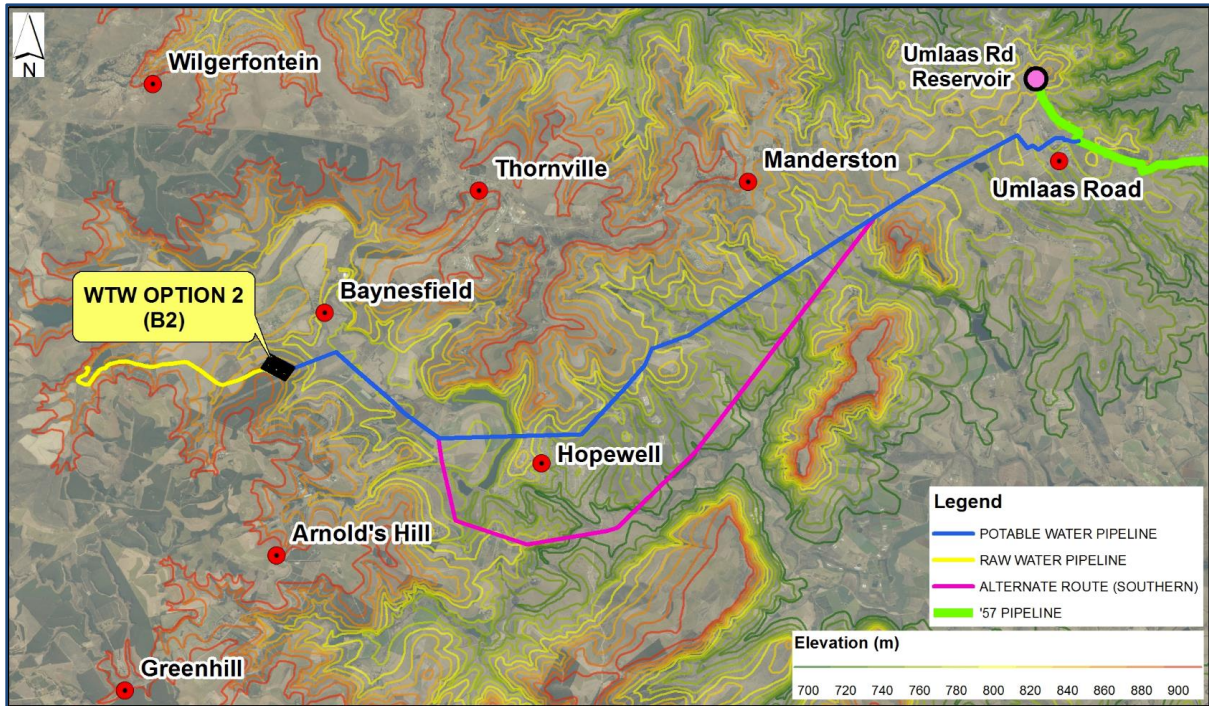

Figure 7.60 Layout of pipeline.

Key information on this project is summarised in **Table 7.52**.

Table 7.52 Project description: uMkhomazi Water Project.

Project Components	<p>Water Resource Components (to be developed by DWS): Smithfield Dam – having a storage capacity 251 million m³ (31% of MAR), earth core rockfill dam. A Transfer Tunnel – 3.5 m bored diameter (3.0 m lined diameter), concrete-lined (where necessary), overall length of 32 km. 3km of 3 000 mm Raw Water Pipeline.</p> <p>Potable Water Supply Components (to be developed by uMngeni-uThukela Water): Water Treatment Plant (WTP) – to be located near Baynesfield Estate with an initial capacity of 500 Ml/day and allowance for further module to increase capacity to 625 Ml/day. 156.25 Ml potable water storage reservoir at WTP. Bulk Potable Water Pipelines –2 820mm diameter (15.1 km) and 2 540 mm diameter (4.6 km) gravity mains from the WTP to '57 pipeline.</p>
Capacity	625 Ml/day

(ii) Institutional Arrangements

DWS will plan, develop and own the water resource and raw water infrastructure up to the WTP. The operation and management component of this infrastructure will be decided at the time of commissioning. uMngeni-uThukela Water will design, build, own, operate and maintain all water supply infrastructure from (and including) the WTP. uMngeni-uThukela Water will purchase raw water from DWS as per a revised raw water agreement and sell potable water from this system to eThekweni, the Msunduzi and uMgungundlovu municipalities, as per the existing bulk water supply agreements.

(iii) Beneficiaries

The scheme will primarily serve the eThekweni Municipal area and to a lesser extent portions of uMgungundlovu District Municipality. Assuming 200 ℓ/person/day, the estimated number of beneficiaries from the anticipated capacity of 625 Mℓ/day may be 3 125 000 people.

(iv) Implementation

The project is divided into three components:

- Module 1: Technical Feasibility Study: Raw Water (Appointment by Department of Water and Sanitation). The study was completed in 2015;
- Module 2: Environmental Impact Assessment (Joint appointment by Department of Water Affairs and uMngeni-uThukela Water). EIA was awarded;
- Module 3: Technical Feasibility Study: Potable Water (Appointment of PSP by uMngeni-uThukela Water). The study was completed in 2015.

The project should have been implemented by 2020 in order to achieve a 99% level of assurance of supply to the uMngeni System. However, the earliest probable commissioning of this scheme is 2030.

The estimated cost of the entire project (raw and potable components) is approximately R 33 billion at 2020 prices. This is made up of R 24.5 billion for the raw water component to be implemented by DWS and R 8 billion for the potable component to be implemented by uMngeni-uThukela Water.

(b) Impendle BWSS

Planning No.	105.44
Project No.	UI0544A
Project Status	Detailed design

(i) Project Description

The area of Impendle has unreliable sources of water and many small run-off-river abstraction and borehole schemes. This project will increase the level of assurance of supply to the community of Impendle as requested by uMgungundlovu District Municipality. The water schemes are part of the Impendle bulk water supply project for the Impendle Local Municipality.

The Impendle Municipality's topography predominantly comprises rolling hills, mountains and scattered settlements covering an area of 948 km². Due to the nature of the area's topography and extended scattered settlements, two separate bulk water supply schemes are proposed.

One bulk scheme will serve the north western part of the Municipality that includes communities from Stepmore to the Lotheni area. The second bulk scheme will provide water to the communities on the east (**Figure 7.61**).

• Stepmore

The proposed source for the scheme is a new river intake to be constructed on the uMkhomazi River. Raw water from this intake will be delivered to a proposed Stepmore Water Treatment Plant (WTP), where the water will be purified. The WTP is situated on a greenfield site and will have a initial capacity of 1.6 Mℓ/day upgradable to 3.0 Mℓ/day when required. From a high-lift pump station within the WTP site, purified water will be delivered through a clear water rising main to Lotheni 1 Reservoir with a capacity of 1Mℓ. From Lotheni 1 Reservoir a gravity main will convey water to Lotheni 2 Reservoir. From the Lotheni 1 and 2 Reservoirs, distribution mains will convey the water by gravity to existing distribution networks in the areas of Stepmore, Inkangala and Lotheni.

uMngeni-uThukela Water will be responsible for the implementation of the Bulk Works from the Abstraction and Water Treatment Plant to the Lotheni 2 Reservoir. Detailed design for the Stepmore area is complete.

• Nzinga

The proposed source for the scheme is a new river intake to be constructed on the uMkhomazi River. Raw water from this intake will be pumped to the proposed Nzinga Raw Water Pump Station (NRWPS) located approximately 190 metres from the intake structure. From the NRWPS, raw water will be delivered through a 325/355 mm diameter x 7.6 km long rising main to the Nzinga WTP located on the same site as the existing WTP. The pipeline is designed to supply 275 kℓ/hr of raw water. The BWSS will be operated and maintained by uMngeni-uThukela Water. Detailed design for the Nzinga area is 25% completed.

Key information on this project is summarised in **Table 7.53**.

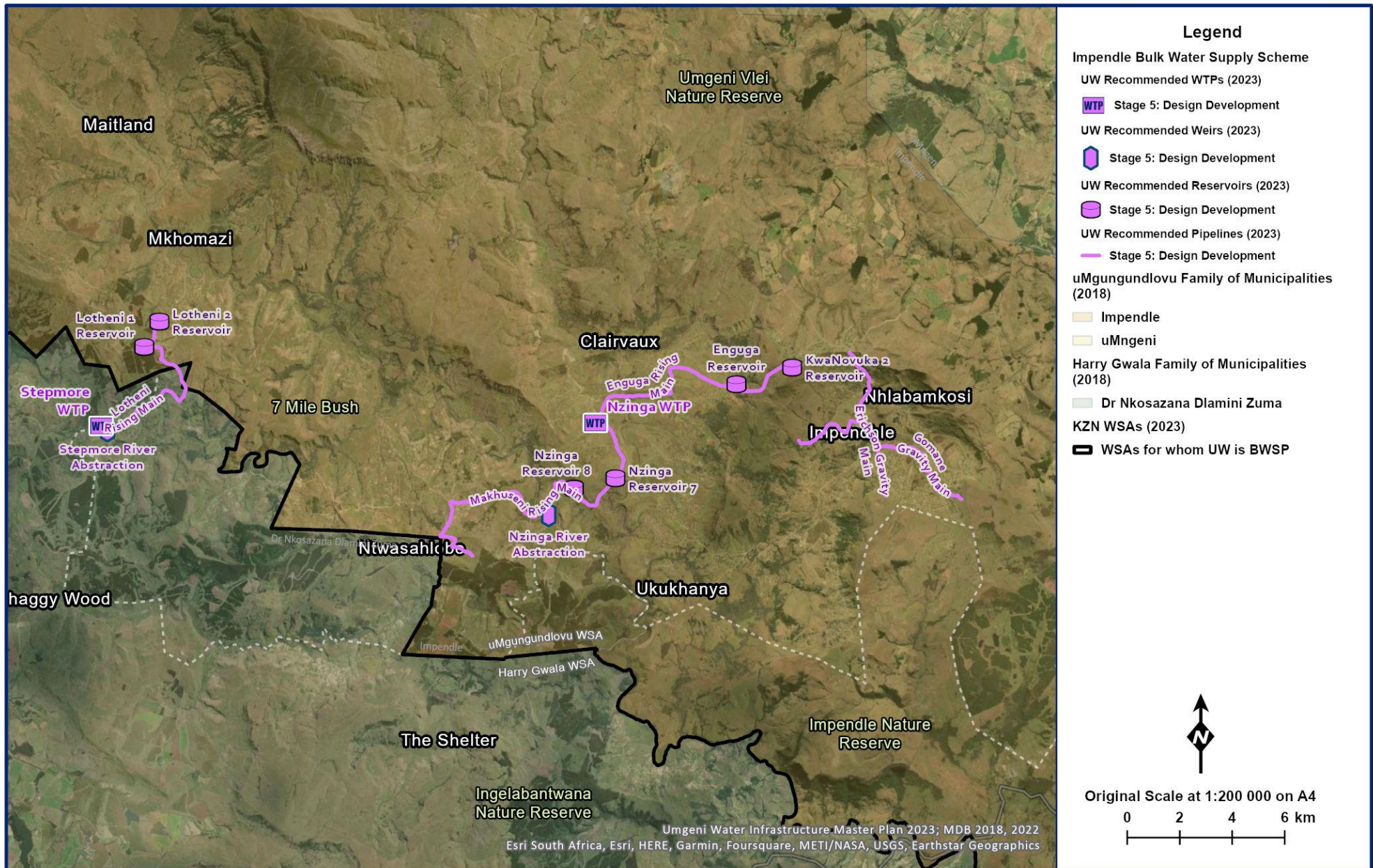

Figure 7.61 General layout of the Impendle Project Areas.

Table 7.53 Project information: Impendle BWSS.

<p>Project Components:</p>	<p>Nzinga Waterworks</p> <ul style="list-style-type: none"> • The proposed plant has a capacity of 13 Mℓ/day with an abstraction capacity of 18 Mℓ/day. • 355 mm diameter x 7.6 km long rising main. • 1 Mℓ Nzinga Reservoir. <p>Stepmore Waterworks</p> <ul style="list-style-type: none"> • The proposed plant has a capacity of 1.6 Mℓ/day upgradable to 3.0 Mℓ/day with an abstraction capacity of 4.0 Mℓ/day • 1 Mℓ Lotheni 1 Reservoir. • 650 kℓ Lotheni 2 Reservoir. • Construction of approximately 11,5 km of 100 mm diameter to 200 mm diameter uPVC and steel pipelines.
<p>Capacity:</p>	<p>15 Mℓ.</p>

(ii) Beneficiaries

The upgrade to the BWSS will benefit consumers within the Impendle Local Municipality with an estimated population of 37 000.

(iii) Implementation

The detail design and construction monitoring of the Nzinga Project is based on a fee-based contract and at the time of tender the value of construction was estimated at R172 million. The construction duration of this project is anticipated to be six years. The total cost is estimated to be R386 million at 2021 prices.

(c) Greater Mpofana Bulk Water Supply Scheme

Planning No.	105.24
Project No.	UI220A
Project Status	Phase 1: Commissioned Phase 2 – Detailed Design

(i) Project Description

Sustained housing development and tourism related activities are increasing the water demand at several nodes along Main Road R103 between Lions River (uMngeni Local Municipality) and Mooi River (Mpofana Local Municipality). This growth is beginning to stress local water resources and water supply infrastructure in the area. The Greater Mpofana Region (described in this report as the area from Mooi River to Lidgetton) does not have a reliable water supply. Much of the area relies on boreholes and run of river abstraction. With increasing demands, the future supply is not considered sustainable.

A regional bulk water supply scheme referred to as the Greater Mpofana Bulk Water Supply Scheme (GMBWSS) is being implemented to ensure that the area has a reliable water supply that will sustain this growth into the future.

Phase 1 of the project has been commissioned and handed over to operations but is now fully operational. This project provides a sustainable bulk water supply to the towns of Mooi River, Rosetta and Nottingham Road.

Phase 2 is currently in the detailed design stage of the project and will provide a sustainable bulk water supply to the towns of Lidgetton and Lions River including the rural hinterland surrounding the abovementioned towns in KwaZulu-Natal.

The GMBWSS (**Figure 7.62**) obtains raw water from Spring Grove Dam on the Mooi River to the Rosetta WTP (Spring Grove WTP) situated adjacent to the dam. From here, potable water is pumped to two command reservoirs. The first reservoir is located at Bruntville in Mooi River. This reservoir serves the greater Mooi River area and will have the potential to supply the Mudén/Rocky Drift area. The Mpofana WTP and Rosetta WTP can then be decommissioned. The second reservoir is at Nottingham Road, which will then supply Balgowan, Lidgetton, Nottingham Road, Gowrie Estates and Lions River. There is also a link pipeline to Mount West. The scheme is to be built in phases to gradually increase the supply area (**Figure 7.63**)

Key information on this project is summarised in **Table 7.54**.

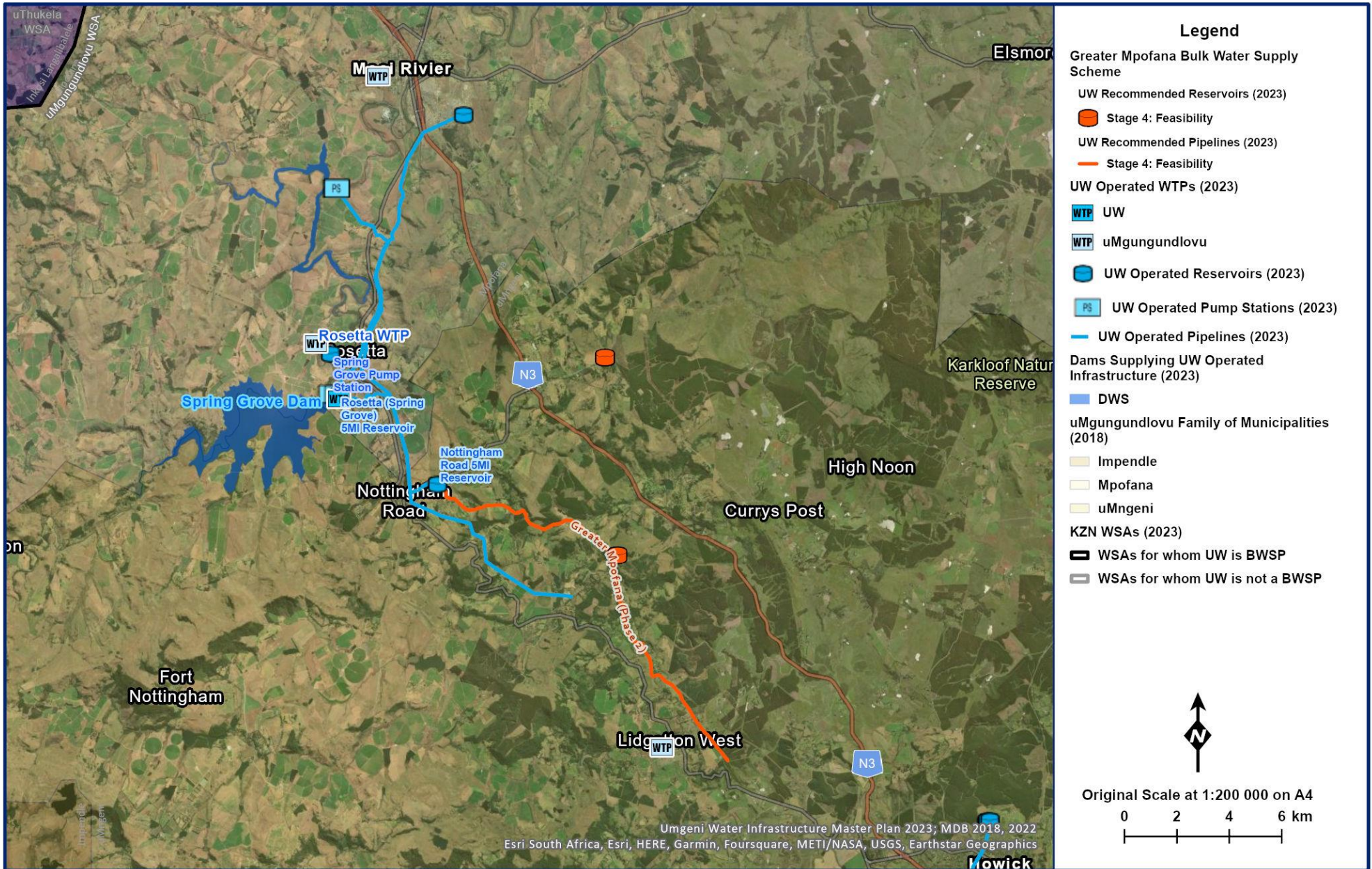

Legend

Greater Mpofana Bulk Water Supply Scheme

- UW Recommended Reservoirs (2023)
 - Stage 4: Feasibility
- UW Recommended Pipelines (2023)
 - Stage 4: Feasibility
- UW Operated WTPs (2023)
 - WTP UW
 - WTP uMgungundlovu
- UW Operated Reservoirs (2023)
 - PS UW Operated Pump Stations (2023)
- UW Operated Pipelines (2023)
 - DWS
- Dams Supplying UW Operated Infrastructure (2023)
 - DWS
- uMgungundlovu Family of Municipalities (2018)
 - Impendle
 - Mpofana
 - uMngeni
- KZN WSAs (2023)
 - WSAs for whom UW is BWSP
 - WSAs for whom UW is not a BWSP

Original Scale at 1:200 000 on A4

0 2 4 6 km

Figure 7.62 Greater Mpofana Bulk Water Supply Scheme.

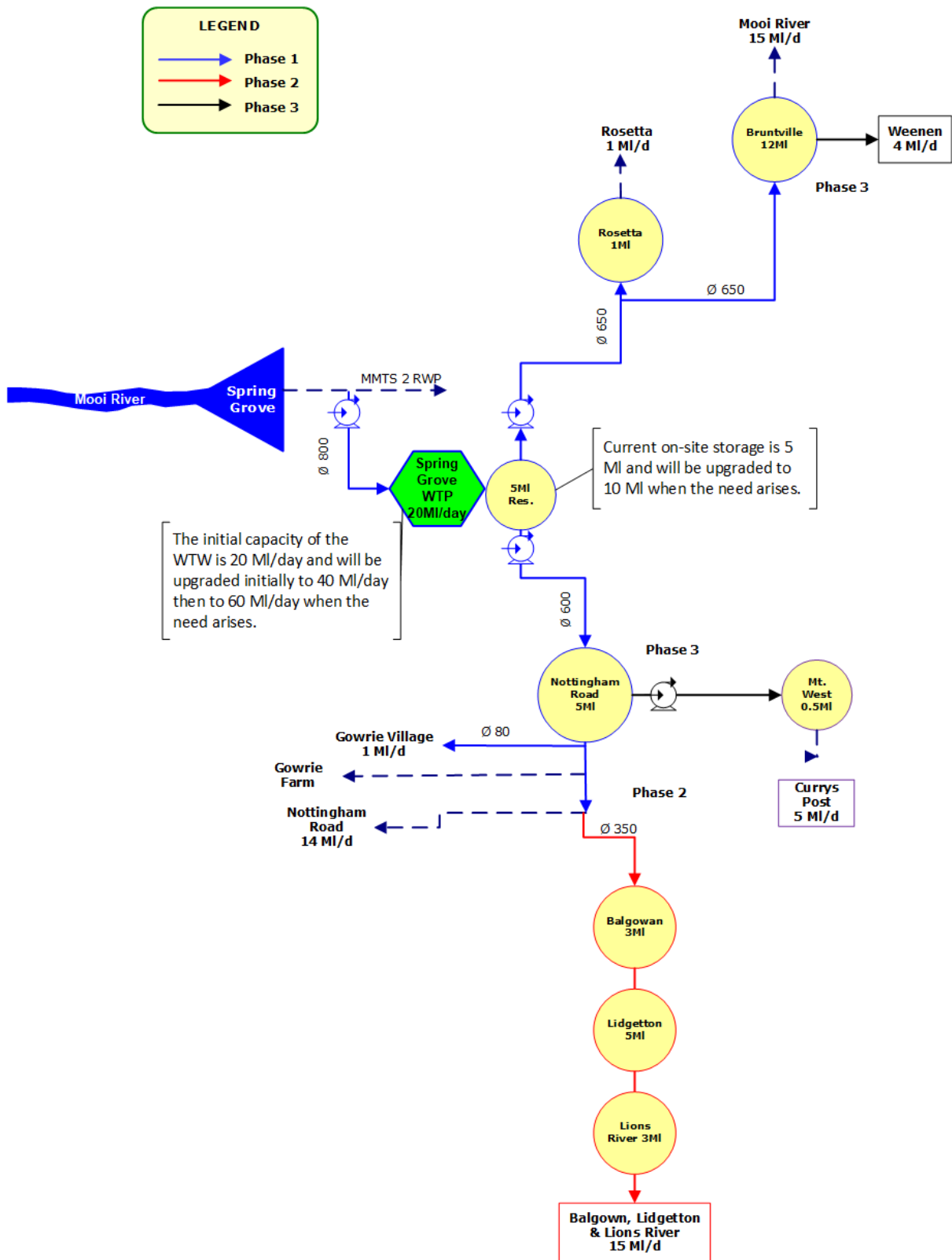

Figure 7.63 Schematic of Greater Mpofana BWSS.

Table 7.54 Project information: Greater Mpofana Bulk Water Supply Scheme.

Project Components:	<p>Phase 1: 20 Mℓ/day Water Treatment Works, associated pump stations, 600 mm diameter pipeline to Nottingham Road and 5 Mℓ reservoir, and 650 mm diameter pipeline to Rosetta and Bruntville in Mooi River with 12 Mℓ reservoir at Bruntville. (Complete)</p> <p>Phase 2: Pipeline from Nottingham Road Reservoir to Balgowan and then Lidgetton and Lions River including three Reservoirs.</p>
Capacity (WTP):	20 Mℓ/day; a further upgrade to be undertaken to 40 Mℓ/day when required and reaching an ultimate capacity of 60 Mℓ/day.

(ii) Institutional Arrangements

uMngeni-uThukela Water will own, operate and maintain this bulk scheme and will sell potable water to the uMgungundlovu District Municipality as per the Bulk Water Supply Agreement. The uMgungundlovu District Municipality will then reticulate to the end consumers through existing and new supply infrastructure.

(iii) Beneficiaries

The scheme will serve residential and tourist establishments in the Mpofana Municipality and uMngeni Municipality within the uMgungundlovu District Municipality. It will also be a source of potable water for low-cost housing in Bruntville and Lions River in the Mpofana and uMngeni municipalities respectively. The forecasted water demand for the Greater Mpofana BWSS is shown in **Table 7.55**.

Assuming 100 ℓ/person/day, the estimated number of beneficiaries from the anticipated initial capacity was 20 Mℓ/day. The current supply to the area is 12 Mℓ/day.

Table 7.55 Water forecasts for the Greater Mpofana BWSS.

Mpofana Municipality	2013	2043
Mooi River	7.3	15.24
Weenen & Msinga	0.00	8.00
Rosetta	0.4	0.85
Mpofana Total	7.7	24.10
Mngeni Municipality	2013	2043
Nottingham Road	1.50	13.6
Mount West & Currys Post	0.0	5.1
Balgowan & Lions River	0.0	14.8
Mngeni Total	1.5	33.5
Total Volume - Expected	9.2	57.6

(iv) Implementation

The project is phased with the first phase consisting of a 20 Mℓ/day WTP at Spring Grove Dam and separate pumping mains to new reservoirs at Bruntville (12 Mℓ) and Nottingham Road (5 Mℓ). The total cost for Phase 1 was R 849 million as at November 2021. Construction has been completed and the project has been commissioned.

Phase 2 is currently at Detailed Design stage. The estimated cost for Phase 2 is R 270 million as at November 2023.

(d) Umbumbulu Pipeline

Planning No.	105.a
Project No.	
Project Status	Detailed Feasibility

(i) Project Description

The capacity of the current pipeline is restricted to 15 Mℓ/day due to the ground level profile along the pipeline route. The flow is restricted to ensure that the hydraulic grade line is at least 20 m above a high point at Stoney Ridge. The current flow in this pipeline is 11 Mℓ/day. The hydraulic analysis has indicated that a new 900mm NB steel pipeline would adequately meet the future 50 Mℓ/day (2045) demand (**Figure 7.65**). This supply could be from the '57 Pipeline or could ultimately be supplied directly from the uMkhomazi Water Project Pipeline. The existing pipeline will be decommissioned once this pipeline is constructed.

Table 7.56 Project information: Umbumbulu.

Project Components:	Designed to deliver approximately 50 Mℓ/day at 2045 demand projections.
Capacity:	50 Mℓ/day ultimate.

(ii) Institutional Arrangements

uMngeni-uThukela Water will own, operate and maintain the pipeline and will sell potable water from this system to uMgungundlovu District Municipality and eThekweni Municipality as per existing bulk water supply agreements.

(iii) Beneficiaries

The beneficiaries will be the Greater Eston region, including the Umbumbulu and the Adams Mission communities. Assuming 100 ℓ/person/day, the estimated number of beneficiaries from the anticipated capacity of 23 Mℓ/day may be 230 000 people.

(iv) Implementation

The construction duration of this project is anticipated to be 5 years and can only be implemented when the uMkhomazi BWSS is implemented.. The total cost is anticipated to be R 983 million as at September 2023.

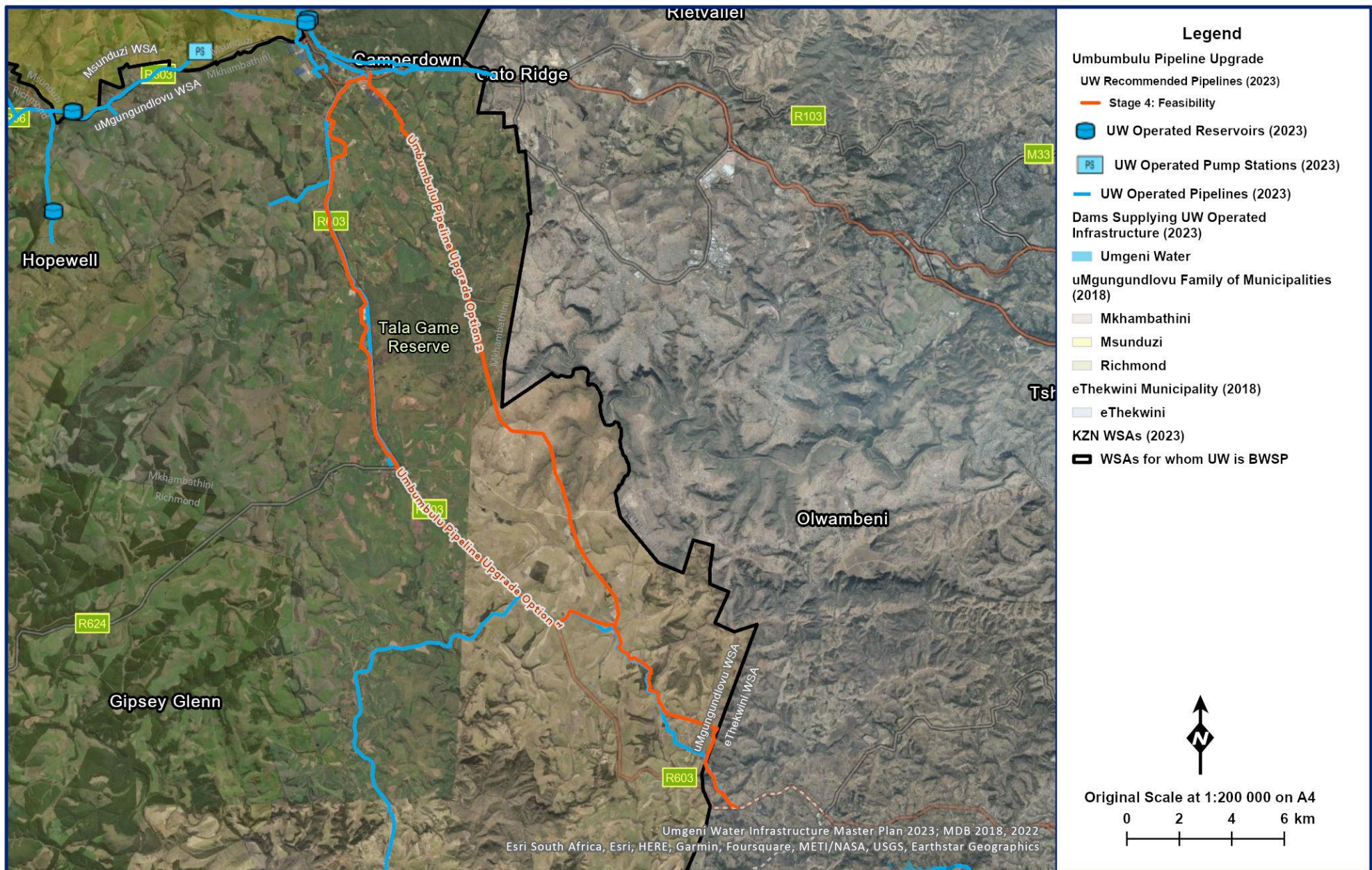

Figure 7.65 General layout of the Umbumbulu Pipeline Upgrade.

(e) Vulindlela Upgrade

Planning No.	105.42
Project No.	UI0901A
Project Status	Phase 1: Construction Phase 2 ; Detailed Design

(i) Project Description

The Vulindlela Bulk Water Supply Scheme (BWSS) was handed over to the Msunduzi Municipality (MM) in 2013 as part of uMngeni-uThukela Water's rationalization strategy. uMngeni-uThukela Water's responsibility ends at the sales meters downstream of the Vulindlela Pump Station. The Vulindlela area has suffered from an insufficient and interrupted water supply. The Msunduzi Local Municipality requested uMngeni-uThukela Water look at a more optimal bulk supply option for the Vulindlela BWSS to ensure an improved supply.

The Vulindlela system (**Figure 7.66**) receives potable water from the Groenekloof Reservoir Complex (TWL of 1210.6 mASL) through two pumping systems via two bulk supply systems. The high-level pumping system feeds two command reservoirs, namely, Reservoir 2 (TWL of 1410.2mASL) and Reservoir 5 (TWL of 1493.93mASL) and two additional reservoirs, Reservoir 3 and Reservoir 4. The low level pumping system only feeds command Reservoir 1. Potable water is then gravity fed from Reservoir 1 to Reservoirs 13 to 19, whilst potable water is gravity fed from Reservoir 2 to Reservoirs 6 to 12.

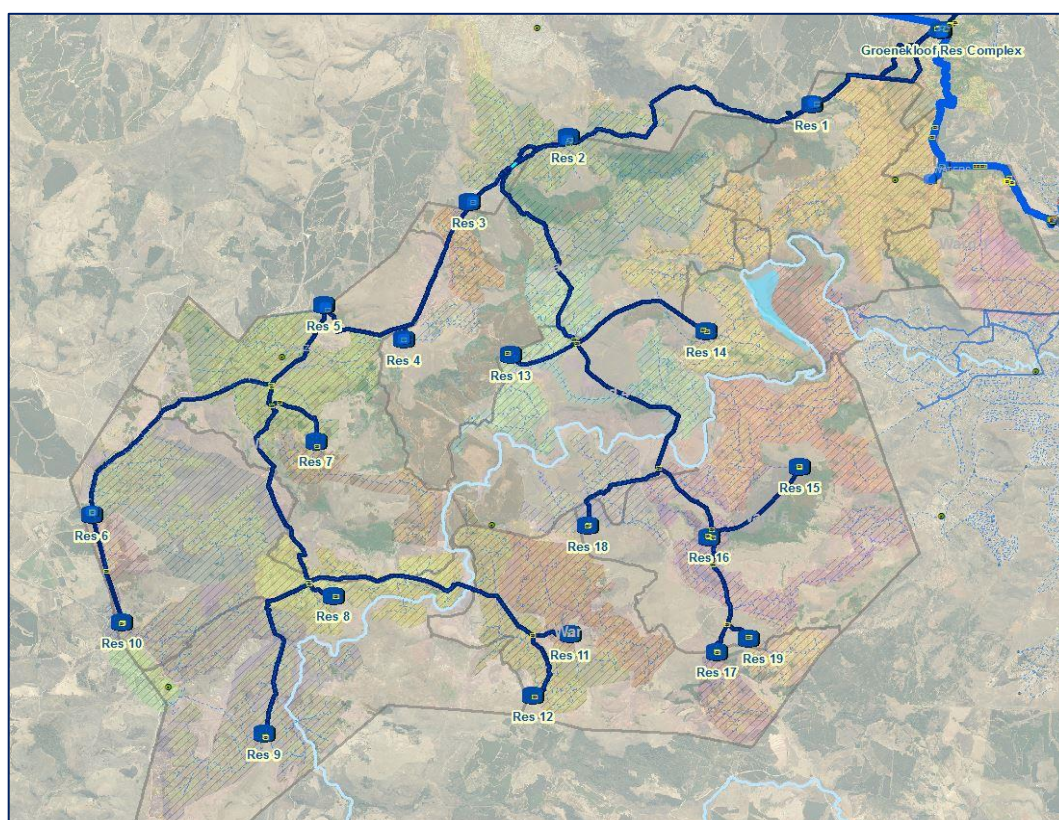

Figure 7.66 General layout of the Vulindlela System.

The Groenekloof High Lift Pump Station consists of three pumps, each with a design duty of 8.64 Mℓ/day at a generated head of 300 m. The current operating philosophy is for two pumps as duty and one as standby, thus having a total duty capacity (theoretical) of 17.28 Mℓ/day. The pumps “hunt” on their curves due to the fact that they have to pump against two different system resistance curves along the same pipeline in their supply of water to Reservoir 2 and Reservoir 5.

The Groenekloof Reservoir serves as a balancing reservoir for Vulindlela, Sweetwaters and Blackridge (**Figure 7.67**). The current demand out of Groenekloof Reservoir is 23 Mℓ/day. An alternative configuration to supply the Vulindlela Reservoir 2 from the existing Howick West Reservoir Complex has been identified and adopted. This configuration will be more efficient and eliminate the need to augment the Groenekloof supply network.

Key information on this project is summarised in **Table 7.57** and illustrated in **Figure 7.67**

Table 7.57 Project information: Vulindlela Upgrade.

Project Components:	<ul style="list-style-type: none"> • Construct a new pump station at Howick West Reservoir Complex to supply Vulindlela Reservoir 2 by installing 3 x 22 Mℓ/day pump sets (2 x operating and 1 x standby). • Construct an 800mm diameter pipeline of 11 km in length from Howick West Pump Station to Reservoir 2. • Construct the Pump Station at Reservoir 2 consisting of 2 x 18 Mℓ/day pump sets (1 x operating and 1 x standby). • Construct one 15 Mℓ Reservoir (25 Mℓ required in total) at Reservoir 2 site as additional storage to the existing 10 Mℓ reservoir. • Construct a back-feed pipeline of 300mm diameter with a length of 6 km, from Reservoir 5 to supply Reservoir 3 and Reservoir 4.
Capacity:	45 Mℓ/day.

(ii) Institutional Arrangements

The Vulindlela BWSS will be operated and maintained by uMngeni-uThukela Water.

(iii) Beneficiaries

The upgrade to the BWSS will benefit consumers within the Msunduzi Municipality and UMDM. Assuming 100 ℓ/person/day, the estimated number of beneficiaries from the anticipated capacity of 45 Mℓ/day may be 50 000 people.

(iv) Implementation

The construction duration of this project is anticipated to be four years. The construction of Phase 1 has commenced and the phase 2 will lag by 6 months. The total cost is estimated at R519 million as at 2023 prices.

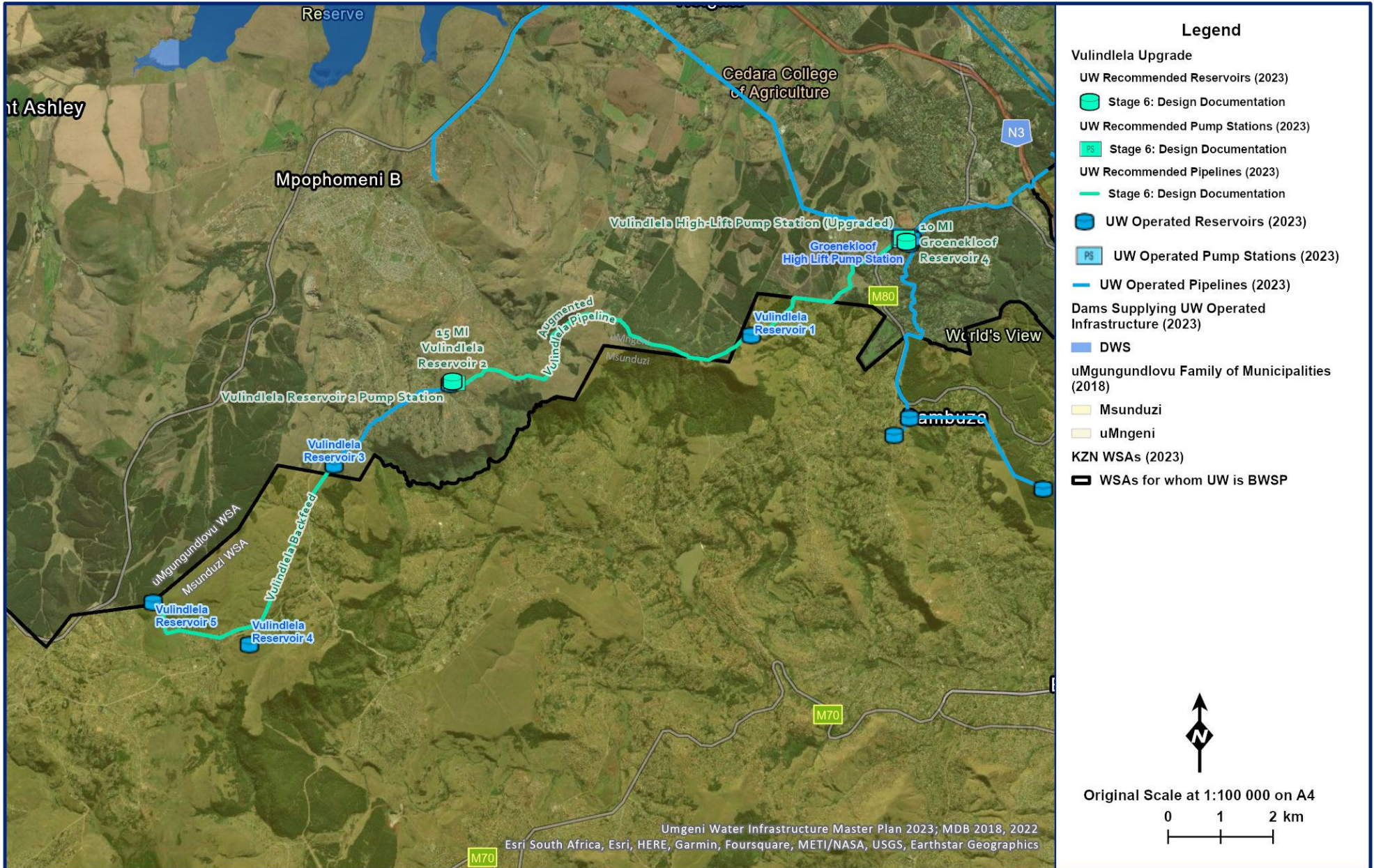

Figure 7.67 Vulindlela Upgrade.

(f) Table Mountain Upgrade

Planning No.	105.41
Project No.	
Project Status	Feasibility Study

(i) Project Description

uMgungundlovu District Municipality requested uMngeni-uThukela Water to consider the augmentation of the existing Table Mountain supply infrastructure to meet current and future demand. The initial assessment indicated that the current infrastructure is inadequate to sustain current demand.

The hydraulic analysis indicated that significant augmentation is required to meet current and future demands. Complete upgrade of the pump station, the bulk supply pipeline and a 4 Mℓ/day reservoir is required to ensure an improved supply and greater assurance of supply over the next 20 years.

A pre-feasibility study identified two possible scenarios to augment the supply to the Greater Table Mountain area. Scenario 1 entails the upgrade of the Lower Glen Lyn Break Pressure Tank to a 2 Mℓ storage facility, replacing the existing Table Mountain pump sets with three new pump sets to meet the current and projected demand and construct a new 4 Mℓ Reservoir at Table Mountain.

Scenario 2 entails a direct feed off a proposed new 23 Mℓ Msunduzi Municipality Whispers Reservoir thus eliminating the need of augmenting the Glen Lyn Break Pressure Tank. The other components, i.e., the pump station and Table Mountain Reservoir would be as per Scenario 1.

Msunduzi Municipality in February 2017 informed uMngeni-uThukela Water that they are revising their Water Master Plan due to the changes in the demarcation of boundaries. The site for the proposed 23 MI Whispers Reservoir now falls within uMshwati Local Municipality. Msunduzi Municipality is negotiating with uMshwati Local Municipality to purchase the land for the construction of the proposed reservoir. The timing is uncertain.

uMgungundlovu District Municipality requested that uMngeni-uThukela Water meet the 3 MI/day demand over the next 5 years. uMngeni-uThukela Water together with uMgungundlovu District Municipality and Msunduzi Municipality agreed to implement some of the recommendations as per Option 1 for the upgrade of the Table Mountain Bulk Water Supply Scheme (BWSS) to meet a demand of 3.0 MI/day. This entails the construction of a 300 mm NB, 500 m long suction pipeline, the installation of 2 x 3.2 MI/day pump sets and the upgrade of the existing switchgear. The cost for the partial upgrade will be attached to the asset management maintenance budget. This project is complete. However, due to the integrity of the rising main to the Table Mountain Intermediate Reservoir, the supply is limited to 2.8 MI/day.

Key information on this project is summarised in **Table 7.58** and **Figure 7.68**.

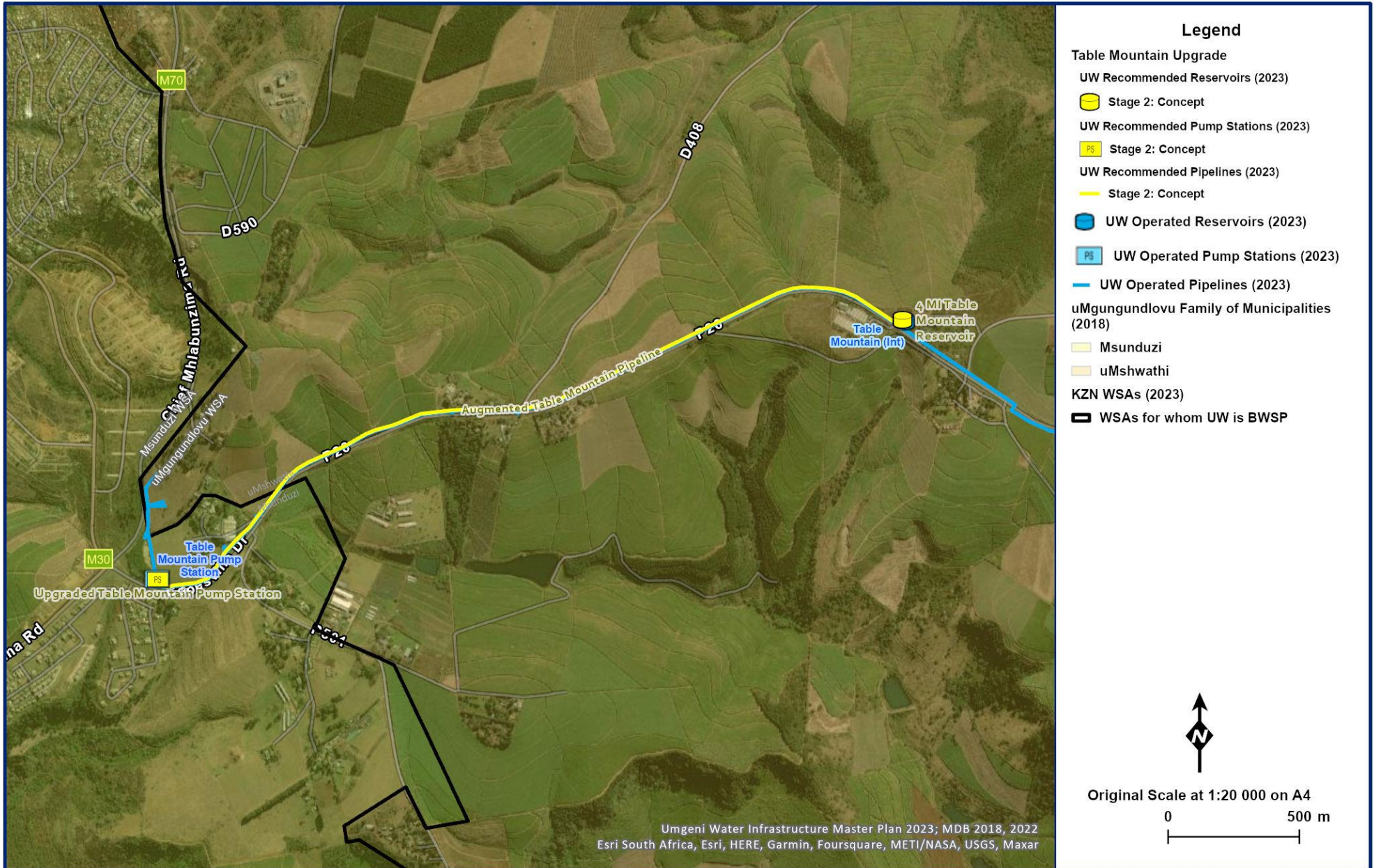

Figure 7.68 Table Mountain Upgrade.

Table 7.58 Project information: Table Mountain Upgrade.

Project Components:	<ul style="list-style-type: none">• 350 mm diameter pipeline, 4.4 km in length.• 4 Mℓ Reservoir.
Capacity:	4 Mℓ.

(ii) Institutional Arrangements

The infrastructure from the buy-back meter will be owned, operated and maintained by uMngeni-uThukela Water.

(iii) Beneficiaries

The upgrade to the BWSS will benefit consumers within the Greater Table Mountain area with estimated population of 13 500.

(iv) Implementation

The implementation of this project is dependent on the augmentation of the Msunduzi Municipality Supply network. Msunduzi Municipality estimate that the augmentation of their water supply system will be implemented by 2027. This project is on hold until such time as a definite directive is obtained for the implementation of the Msunduzi Municipality Supply Network.

(g) Hydropower Unit at the Mpofana Outfall

Planning No.	609.2
Project No.	CI.00003
Project Status	Detailed Design

(i) Project Description

A Detailed Feasibility Study (DFS) to assess the viability of a Hydropower Unit on the Mooi-uMngeni Transfer Scheme (MMTS) was initiated in 2013. A cost benefit model was developed to investigate the benefit of installing larger pipe sizes under the second phase of the MMTS in the gravity section of the pipe from the Gowrie Break Pressure Tank to the Mpofana Outfall Site (Figure 7.76). It was identified that a 914 mm diameter steel pipe had the highest Internal Rate of Return (IRR), and therefore is the optimal size for installation. The residual head available for power generation at the outfall site under full flow conditions for a new pipe scenario is 148 m, and under aged pipe conditions is 128 m.

The DFS has shown that a dual turbine powerhouse at the Mpofana Outfall Site, with twin turbo type turbines, each capable of discharging 2.25 m³/s at 148 m head, can produce 2.698 MW each (5.396 MW total).

Electrical transmission of the power generated will be fed back into the National Grid at the Gowrie Substation in Nottingham Road. The recoupment of costs will be offset against the power generated and billed to uMngeni-uThukela Water, for the MMTS, by Eskom.

A hydropower unit on the MMTS will recover between 19.7 and 16.8 GW.hr/annum of power, based on MMTS operation for 6 months of the year at 83% efficiency, and depending on the age of the supply pipelines.

(ii) Institutional Arrangements

The new infrastructure will be owned, operated and maintained by uMngeni-uThukela Water.

(iii) Beneficiaries

The MMTS Hydropower Project is economically feasible with an expected payback period of 5 years. Thereafter the project will save uMngeni-uThukela Water and hence consumers an estimated R14 million per annum at the current electricity tariff.

This saving in the operating costs can be offset in the tariff, which will benefit all consumers within uMngeni-uThukela Water's area of jurisdiction.

(iv) Implementation

The total cost is estimated to be approximately R 350 million as at 2023 prices. uMngeni-uThukela Water obtained permission from the Department of Water and Sanitation for access to their infrastructure and is now at the Detailed Design phase of the hydropower unit.

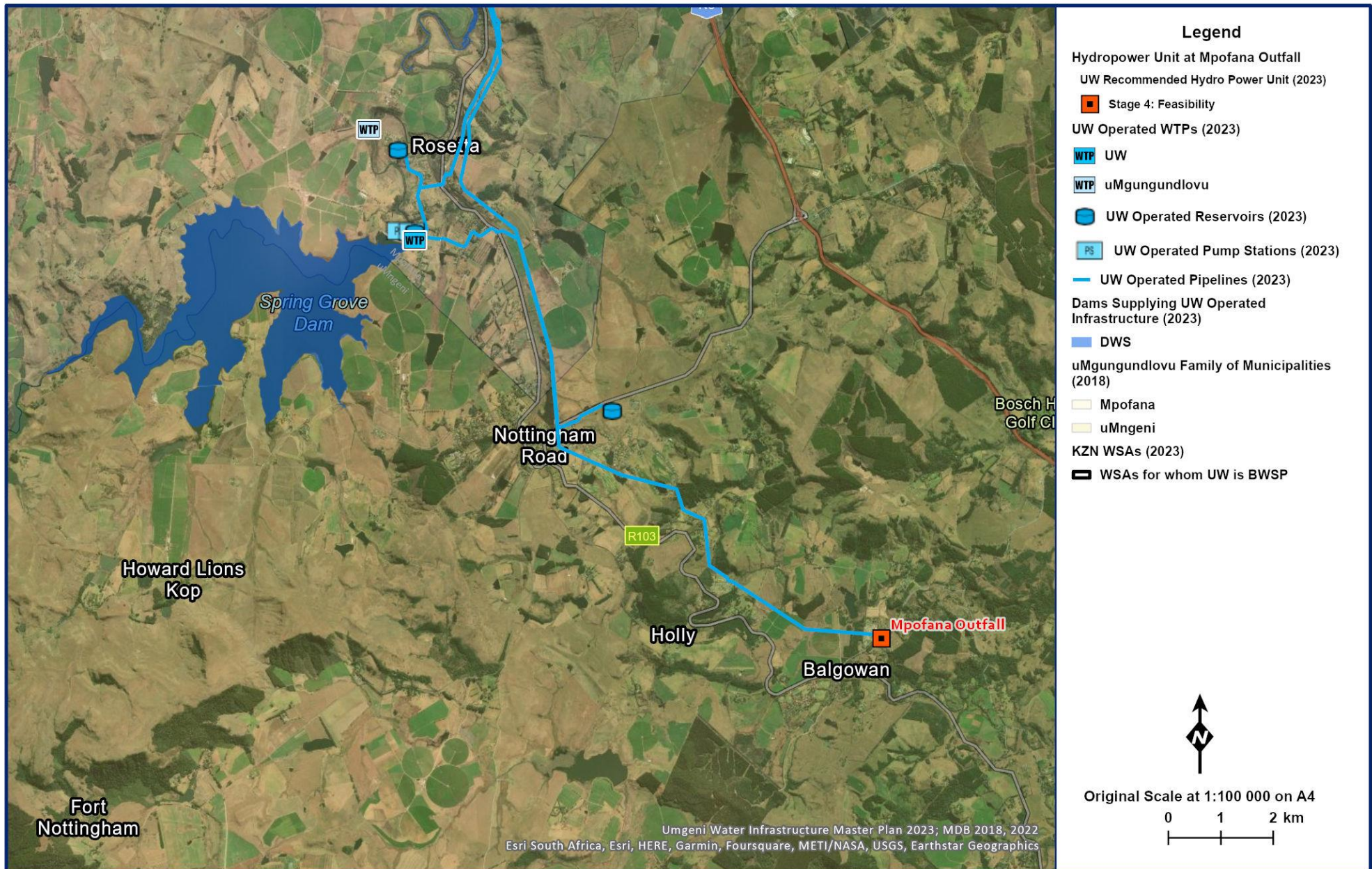

Figure 7.69 Layout of the proposed hydropower unit at the Mpofana Outfall.

7.6 Management and Operation of uMgungundlovu Water Treatment Plants (WTPs)

In 2016, uMgungundlovu District Municipality requested that uMngeni-uThukela Water manage and operate four WTPs under their jurisdiction. uMngeni-uThukela Water agreed to the request under a Memorandum of Understanding (MOU).

The four WTP's (**Figure 7.70**) are:

- Appelsbosch WTP (Decomissioned)
- Lidgetton WTP;
- Mpofana WTP; and
- Rosetta WTP;

Figure 7.70 General layout of the four uMgungundlovu WTPs being operated and managed by UMngeni-uThukela Water.

7.6.1 Lidgetton WTP

The Lidgetton WTP (Table 7.59; Figure 7.71) is located in uMngeni Municipality and supplies the village of Lidgetton from the Lions River (Figure 7.72).

Plans are in place to implement the Mpofana BWSS Phase 2, which is the supply to Lidgetton from the Mpofana BWS, as there is an increase in demand in this area. In the interim, the capacity of the existing plant has been “upgraded” (Figure 7.73), by the addition of package clarifiers and filters as shown in Table 7.59.

Table 7.59 Characteristics of the Lidgetton WTP.

	Current	Package Plant 2019/2020
WTP Name:	Lidgetton WTP	Lidgetton WTP
System:	UMDM	UMDM
Maximum Design Capacity:	0.5 MLD	1 MLD
Current Utilisation:	0.448 MLD	N/A
Raw Water Storage Capacity:	-	-
Raw Water Supply Capacity:	2.3 MLD @ 22.5 m	1.2 MLD @ new system head
Pre-Oxidation Type:	N/A	N/A
Primary Water Pre-Treatment Chemical:	N/A	Polymeric Coagulant
Total Coagulant Dosing Capacity:	N/A	2 x 6 l/h
Rapid Mixing Method:	N/A	Static mixer
Clarifier Type:	N/A	Package Lamella clarifiers
Number of Clarifiers:	N/A	2
Total Area of all Clarifiers:	N/A	38 m ²
Total Capacity of Clarifiers:	N/A	2.4 MLD
Filter Type:	Slow sand filtration	Pressure filters
Number of Filters:	3	4
Filter Floor Type	-	-
Total Filtration Area of all Filters	75 m ²	14 m ²
Total Filtration Design Capacity of all Filters:	0.5 MLD	2.4 MLD
Total Capacity of Backwash Water Tanks:	N/A	To be determined
Total Capacity of Sludge Treatment Plant:	N/A	To be determined
Capacity of Used Washwater System:	N/A	To be determined
Primary Post Disinfection Type:	Calcium hypochlorite granules	Sodium hypochlorite
Disinfection Dosing Capacity:	2 x 6 l/h	2 x 6 l/h
Disinfectant Storage Capacity:	20L drums; stored in the chemical room	To be stored in 25 L drums ,in the chemical room
Total Treated Water Storage Capacity:	Onsite sump: Estimated to be 80 m ³	Onsite sump: Estimated to be 80 m ³

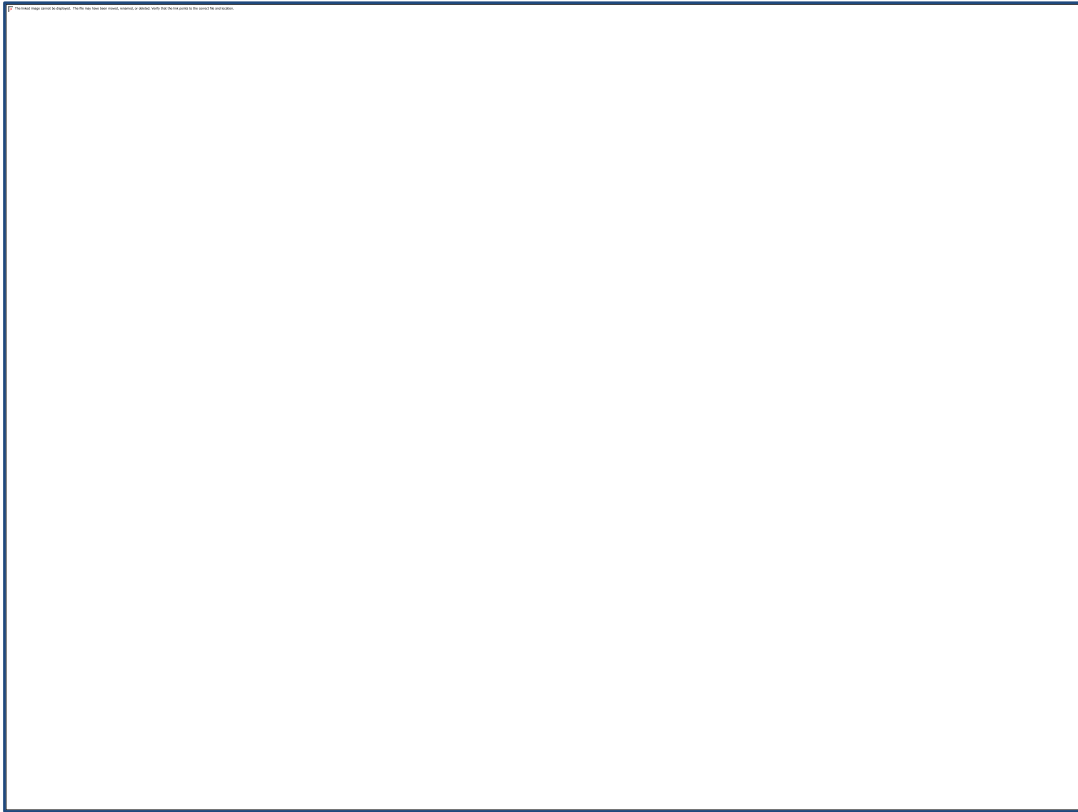

Figure 7.71 Lidgetton WTP sand wash bays with old dosing system (uMgungundlovu District Municipality 2010)

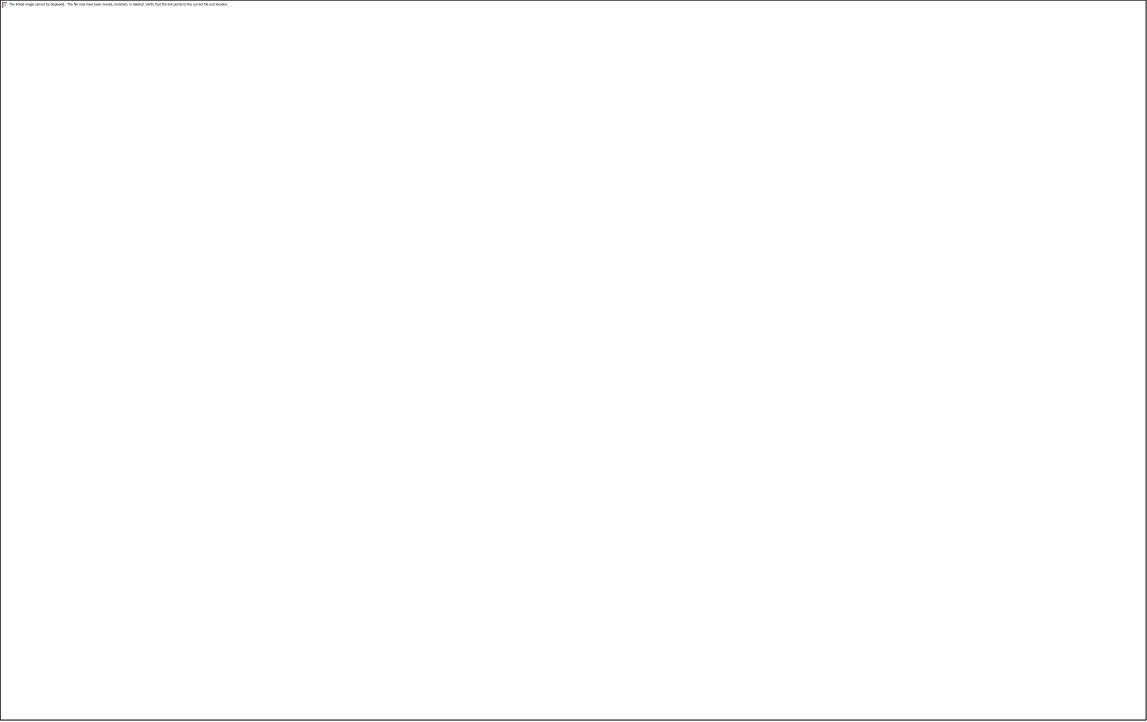

Figure 7.72 Schematic of the Lidgetton System (subject to verification).



Figure 7.73 1 MI/day being constructed at the Lidgetton System.

An analysis of daily historical production (November 2022 to October 2023) of the Lidgetton WTP is presented in **Figure 7.74**. It shows that for 28.88% of the time the WTP was being operated above the optimal operating capacity for the period as stipulated and 17.98 % above the upgraded design capacity.

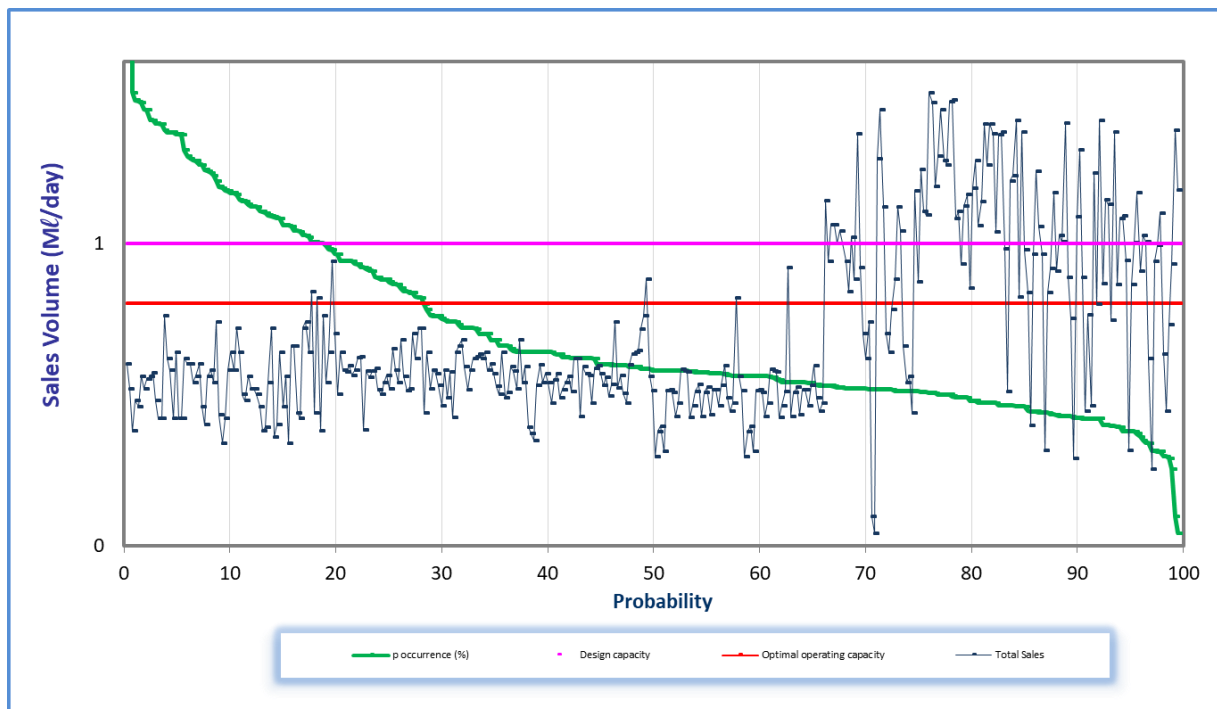

Figure 7.74 Analysis of historical production at Lidgetton WTP (November 2022 to October 2023).

The growth in demand is estimated at 1.5 % per annum over the next two years (**Figure 7.75**). It is envisaged that the 1 Mℓ/day package plant will, thereafter, be fully operational.

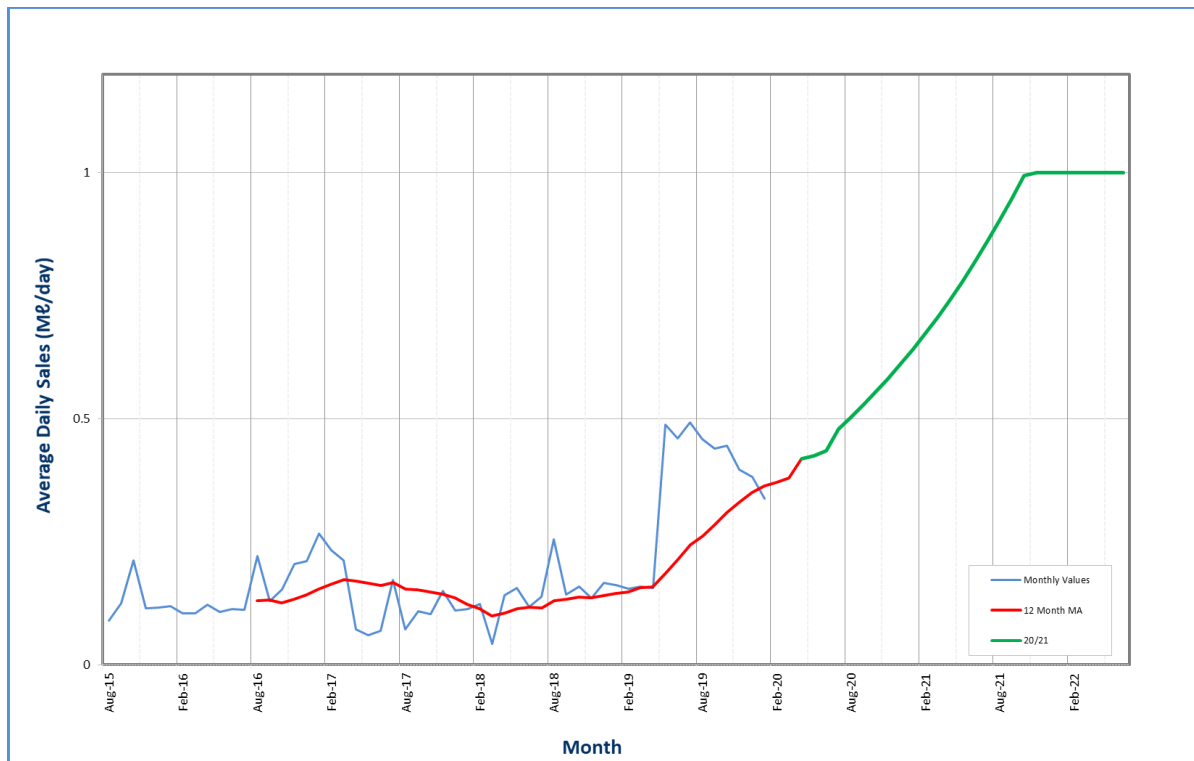

Figure 7.75 Water demand from Lidgetton WTP.

This plant will be decommissioned when the Mpopana BWSS Phase 2 Supply System is implemented by the year 2027.

7.6.2 Mpofana WTP

The Mpofana WTP (Table 7.60) abstracts water from the Mooi River to supply the town of Mooi River and Bruntville, located in Mpofana Local Municipality (Figure 7.76; Figure 7.77).

Table 7.60 Characteristics of Mpofana WTP.

WTP Name:	Mpofana WTP Main Plant	Package Plant
System:	Mpofana System	Mpofana System
Maximum Design Capacity:	6 ML/d	2ML/d
Current Utilisation:	5.2ML/d	1 ML/d
Raw Water Storage Capacity:	327 m ³	Pumps from main raw water holding tank
Raw Water Supply Capacity:	-	2 X 84 m ³ /hr
Pre-Oxidation Type:	-	-
Primary Water Pre-Treatment Chemical:	Rheofloc 5113 XI	Rheofloc 5113 XI
Total Coagulant Dosing Capacity:	10 ℓ/hr	7.5 ℓ/hr
Rapid Mixing Method:	Inline static mixer	Mechanical Stirrer
Clarifier Type:	Dortmund Type Clarifier	Lamella plate clarifier
Number of Clarifiers:	4	2
Total Area of all Clarifiers:	256 m ²	42 m ²
Total Capacity of Clarifiers:	9.2 ML/d	2 ML/d
Filter Type:	Rapid Gravity Sand Filters	Pressure Filters
Number of Filters:	4	3
Filter Floor Type	-	-
Total Filtration Area of all Filters	48 m ²	16.7 m ²
Total Filtration Design Capacity of all Filters:	6.0 ML/d	2 ML/d
Total Capacity of Backwash Water Tanks:	1 x 10 m ³	2 x 20 m ³
Total Capacity of Sludge Treatment Plant:	-	-
Capacity of Used Washwater System:	-	Recycled to raw water holding tank
Primary Post Disinfection Type:	Chlorine gas	Sodium Hypochlorite (12.5%v/v)
Disinfection Dosing Capacity:	600 g/h	20 l/h
Disinfectant Storage Capacity:	4 x 70kg cylinders	200 ℓ
Total Treated Water Storage Capacity:	5 x 1 ML Reservoirs	Feed to Reservoir No.04 & No.05

The existing Mpofana WTP experiences operational difficulty during high rainfall periods as it does not have the capacity to treat high turbidity raw water. The new Rosetta WTP is commissioned as part of the Mpofana BWSS and currently supplies the Bruntville supply area. The Mpofana WTP is still operational albeit only to supply the Mooiriver supply node. Plans are in place to backfeed along the existing rising main from the new 12 ML Bruntville Reservoir to the existing Mpofana WTP and on supply to the Mooiriver supply node. The anticipated commissioning of this proposal is towards the end of 2026. Then the Mpofana WTP will be fully decommissioned.



Figure 7.76 Schematic of the Mpofana System (subject to verification).



Figure 7.77 Mpofana WTP (uMgungundlovu District Municipality 2010).

An analysis of daily historical production (November 2022 to October 2023) of the Mpofana WTP is presented in **Figure 7.78**. It shows that for 26.5% of the time the WTP was being operated above the optimal operating capacity and 0% above the current design capacity (based on the “upgraded capacity” of 8 Mℓ/day) for the period as stipulated. The historical and projected future demand from the Mpofana WTP is shown in **Figure 7.79**.

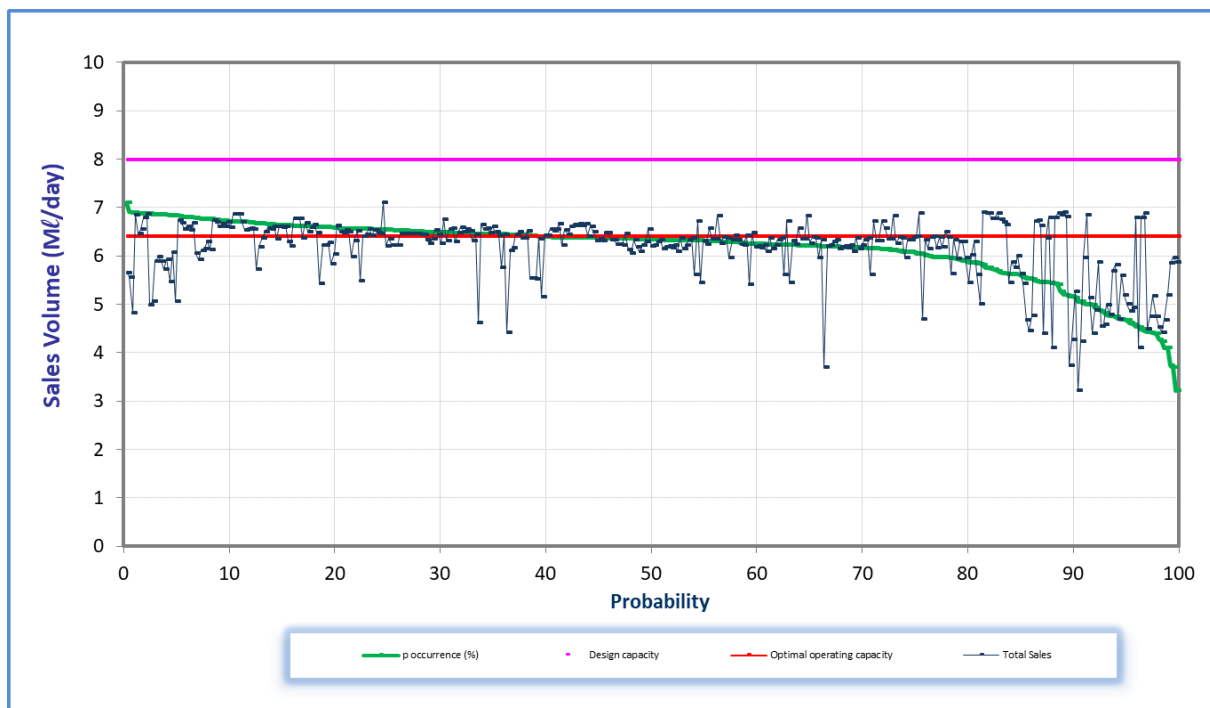

Figure 7.78 Analysis of historical production at Mpofana WTP (November 2022 to October 2023).

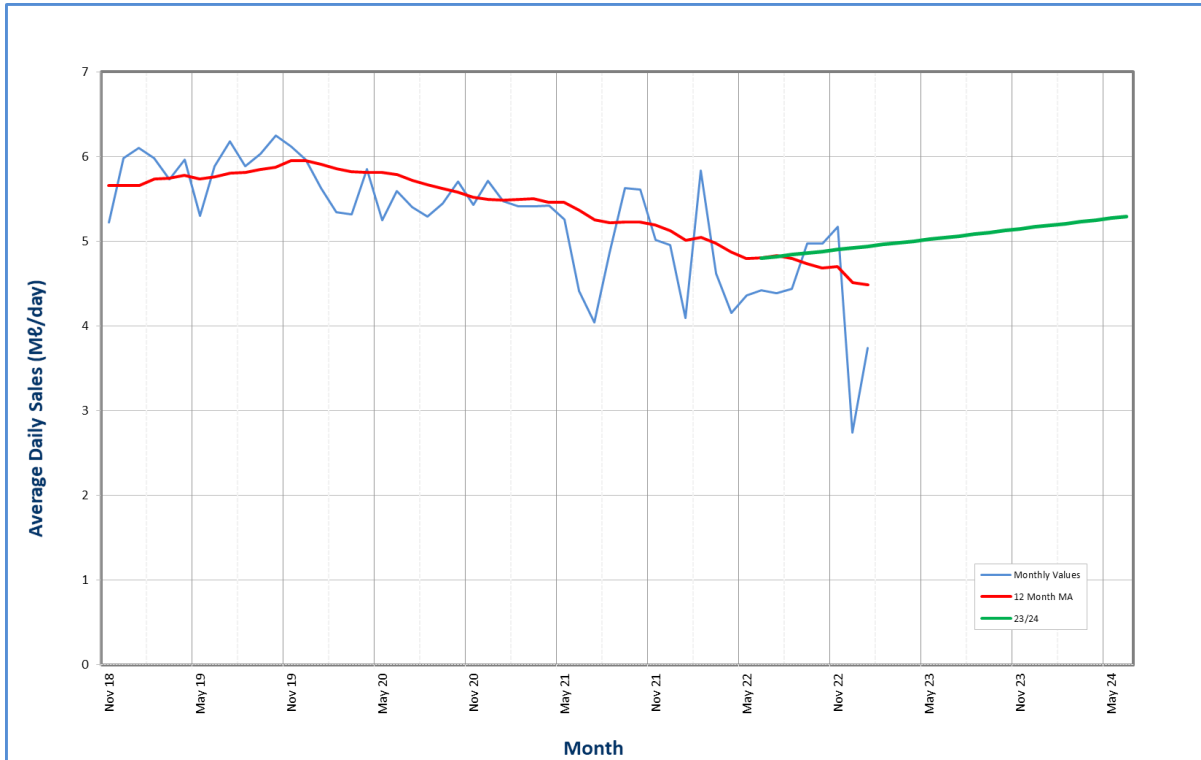

Figure 7.79 Water demand from Mpofana WTP.

With the implementation of a 2 ML/day Package Plant (**Figure 7.80**), it was expected that the demand would increase to 8 ML/day. However, the closure of the textile plant reduced the overall demand of the supply system. With the commissioning of the new Rosetta WTP and the completion of the Bruntville Pipeline, the Mpofana WTP currently produces 0.5 ML/day to meet the demand of the Mooiriver supply node and will be in operation until end of 2026 when the Mooiriver supply node will be supplied from the Bruntville Reservoir.



Figure 7.80 Mpofana Package Plant.

7.6.3 New Spring Grove WTP

The new Spring Grove WTP (Table 7.61; Figure 7.81), commissioned in June 2023, abstracts water from Spring Grove Dam as part of the Mpofana BWSS to supply the village of Rosetta, Mooiriver, Bruntville and Nottingham Road in Mpofana Municipality (Figure 7.82). The commissioning of this plant allowed for the de-commissioning of the old Rosetta WTP

Table 7.61 Characteristics of the new Spring Grove WTP.

WTP Name:	Spring Grove WTP
System:	Mpofana Bulk Water Supply System
Maximum Design Capacity:	20 MI/day
Current Utilisation:	6 MI/day
Raw Water Storage Capacity:	139 million m3
Raw Water Supply Capacity:	20 MI/day
Pre-Oxidation Type:	Pre-chlorination
Primary Water Pre-Treatment Chemical:	Rheofloc 5113 XI
Total Coagulant Dosing Capacity:	2.5 ppm
Rapid Mixing Method:	Hydraulic jump
Clarifier Type:	Pulsators
Number of Clarifiers:	3
Total Area of all Clarifiers:	140 m2
Total Capacity of Clarifiers:	3.2 m3/hr
Filter Type:	Rapid gravity Filters
Number of Filters:	4
Filter Floor Type	Concrete with perforated nozzle
Total Filtration Area of all Filters	194 m2
Total Filtration Design Capacity of all Filters:	20 MI/day
Total Capacity of Backwash Water Tanks:	184 m3
Total Capacity of Sludge Treatment Plant:	3 MI/day
Capacity of Used Washwater System:	200 m3 x 2
Primary Post Disinfection Type:	Chlorine
Disinfection Dosing Capacity:	3.6 ppm x 3
Disinfectant Storage Capacity:	4000 ℓ
Total Treated Water Storage Capacity:	5 MI



Figure 7.81 Spring Grove WTP

The WTP started producing 5.6 MI/day, when the Bruntville pipeline was commissioned in August 2023

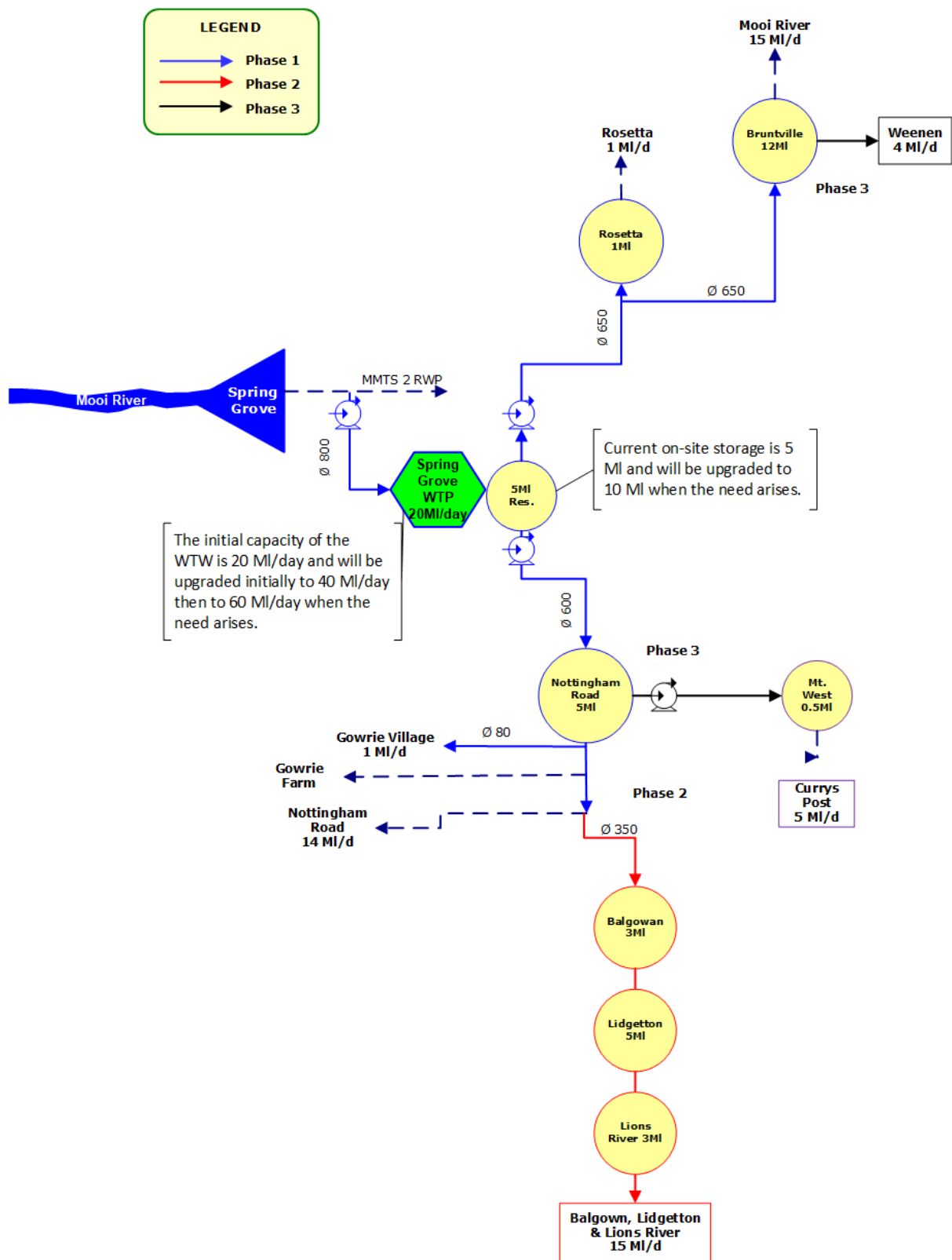

Figure 7.82 Schematic of the Spring Grove WTP System (subject to verification).

An analysis of daily historical production (November 2022 to October 2023) of the old Rosetta WTP and the commissioning of the Spring Grove WTP is presented in **Figure 7.83**. It shows that for 76.5% of the time the WTP was being operated above the optimal operating capacity and 43.73% above the current design capacity for the period as stipulated.

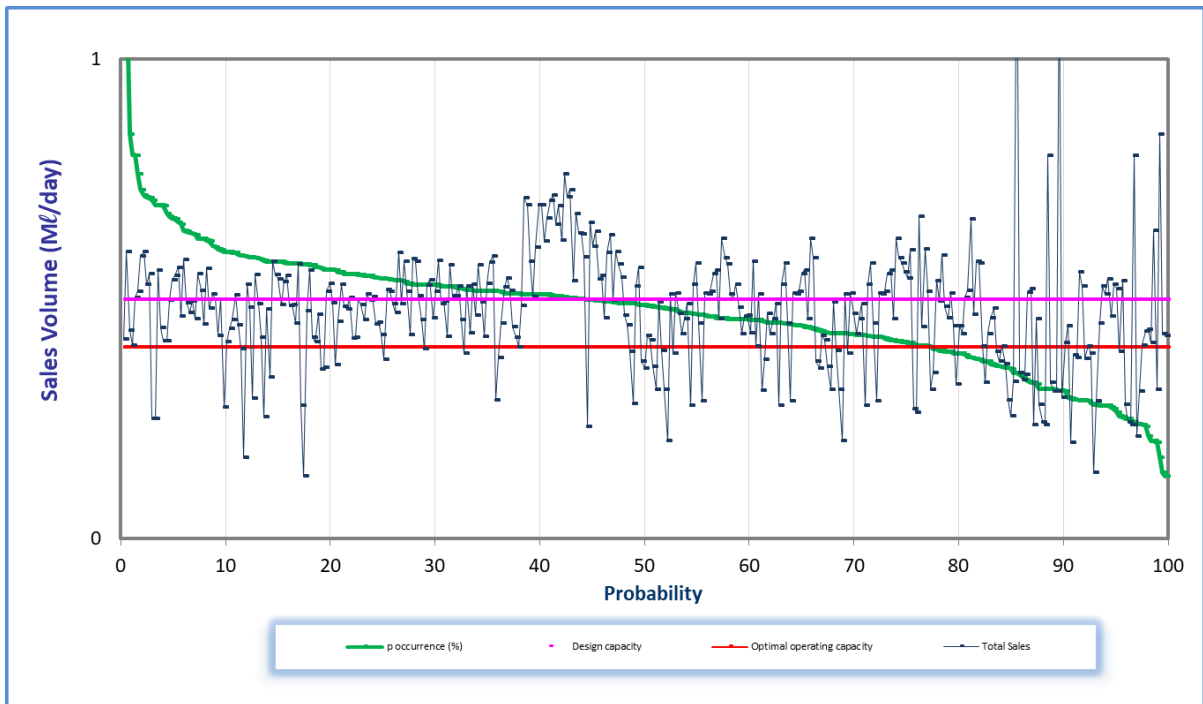

Figure 7.83 Analysis of historical production at Spring Grove WTP (November 2022 to October 2023).

This old Rostta WTP has now been decommissioned since August 2023, when the new Spring Grove WTP became operational. The current supply from the new Spring Grove WTP is 5.6 ML/day as shown below in **Figure 7.84**.

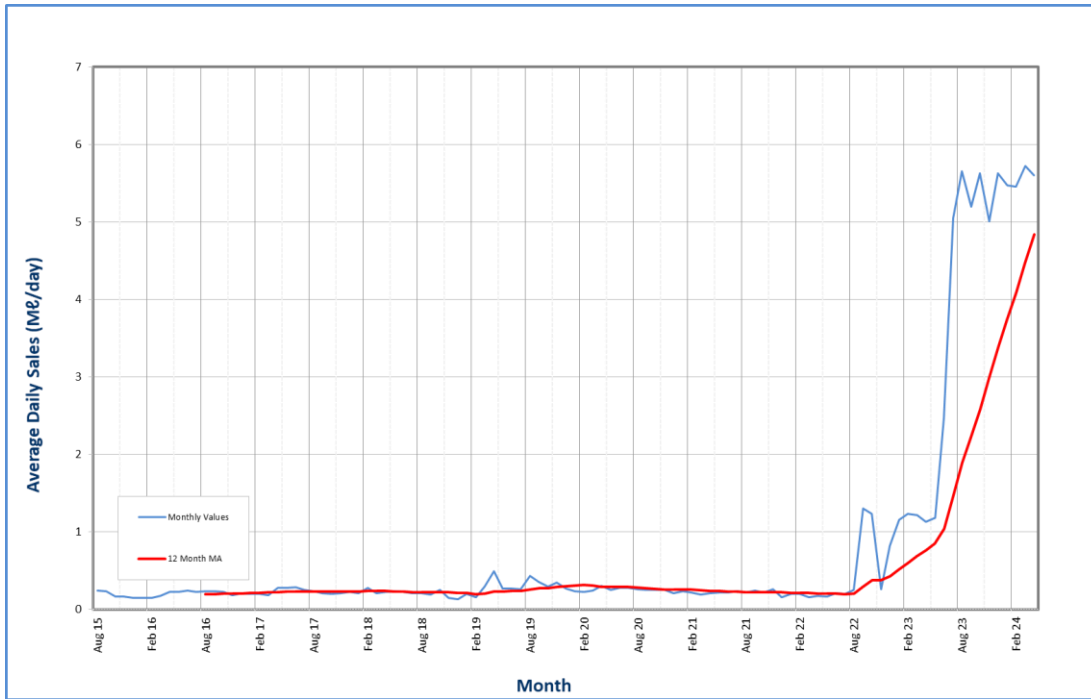

Figure 7.84 Water demand from Spring Grove WTP.

UMDM with the assistance of U UW is in the process of implementing a secondary supply system from Bruntville Reservoir to supply the town of Moorriver and will be complete by December 2024. This will increase the projected demand to 8 MI/day.

This section should be read in conjunction with **Section 7.6.2**

7.7 uMzinyathi Water Treatment Plants

7.7.1 Muden WTP and Supply System

(a) Description of the Muden WTP and Supply System

The Muden Water Supply Scheme is located in the lower reaches of the Mooi catchment in the Mvoti Local Municipality (**Figure 7.85**) and is operated by the uMzinyathi WSA.

The scheme is currently supplied from boreholes and abstractions from the Mooi River (**Table 7.62**). The long-term water demand for the uMzinyathi DM section of the Muden Water Supply Scheme is estimated at 15.78 Mℓ/day. The Mooi River remains the most viable source of water for the scheme. The MAR at the abstraction point was calculated at 49.85 million m³, according to page 33 of the Muden All Town Recon Strategy (Department of Water and Sanitation. 2011. First Stage Reconciliation Strategy for Muden Water Supply Scheme Area - uMvoti Local Municipality).

Table 7.62 Summary of Muden WTP Supply System existing infrastructure (DWS 2011).

Scheme Area	Source	Water Treatment Plant	Reservoir Capacity (Mℓ)
Muden	Mooi River	Muden WTP – 11.00 Mℓ/day, conventional plant	8
	Boreholes	Borehole – 1.58 Mℓ/day	

The raw water sources for the Muden Supply System is 1) the Mooi River, which supplies the Muden WTP, and 2) seven boreholes, which supply directly into reticulated networks (**Figure 7.86**). Abstraction from the Mooi River takes place at several locations, however, the ideal abstraction position for the scheme is at an existing irrigation canal in Muden. The canal's supply is from a weir constructed on the Mooi River, located approximately 7 km from the existing Muden WTP (**Table 7.63** and **Figure 7.87**). The irrigation canal feeds water to the existing treatment plant via gravity, from where it is distributed to the Muden and Opathe areas. The Craigieburn Dam, which is situated between Mooi River and Greytown, augments the the flow in the Mooi River as and when required.

The pump details, reservoir details and pipeline details for the Muden Supply System are listed in **Table 7.64**, **Table 7.65** and **Table 7.66** respectively.

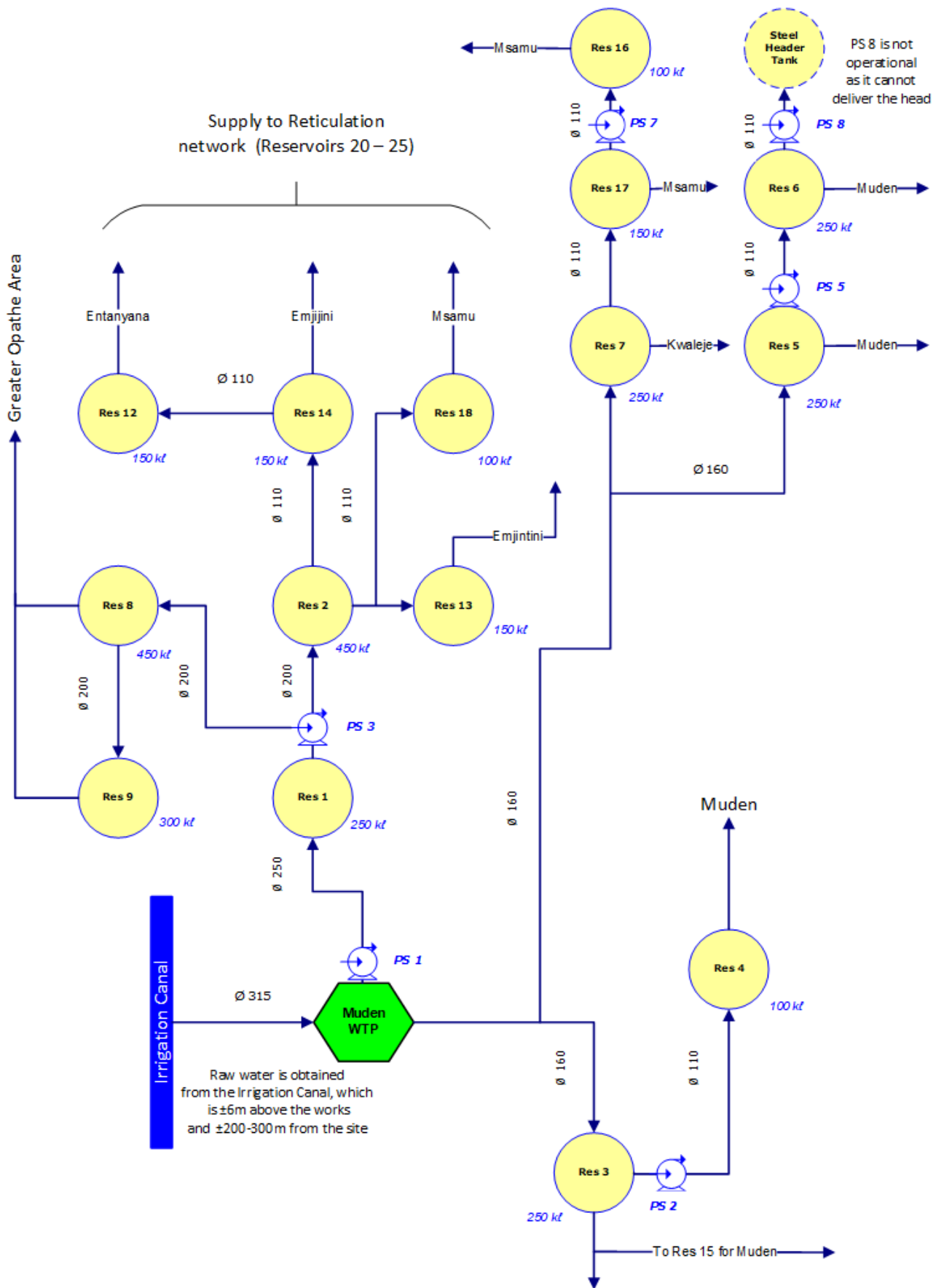

Figure 7.86 Schematic of the Muden Supply System.

The characteristics of the Muden WTP are shown in **Table 7.63**.

Table 7.63 Characteristics of the Muden WTP.

WTP Name:	Muden WTP
System:	Mvoti Supply System
Maximum Design Capacity:	11 Mℓ/day (3 Mℓ/day old plant + 8 Mℓ/day new plant)
Current Utilisation:	2.798 Mℓ/day
Raw Water Storage Capacity:	0 Mℓ
Raw Water Supply Capacity:	3.0 Mℓ/day due to constraint of irrigation canal
Pre-Oxidation Type:	None
Primary Water Pre-Treatment Chemical:	Polymeric Coagulant
Total Coagulant Dosing Capacity:	13 ℓ/hour (running at 50%)
Rapid Mixing Method:	Conventional Paddle Flash Mixer
Clarifier Type:	Dortmund manual clarifiers
Number of Clarifiers:	6 (2 old and 4 new)
Total Area of all Clarifiers:	140.4 m ² (28.08 m ² old and 112.32 m ² New)
Total Capacity of Clarifiers:	12.5 Mℓ/day
Filter Type:	Constant Rate Rapid Gravity Filters
Number of Filters:	8 (2 Old and 6 New)
Filter Floor Type	Laterals with Nozzles
Total Filtration Area of all Filters	83.64 m ²
Total Filtration Design Capacity of all Filters:	12.5 Mℓ/day
Total Capacity of Backwash Water Tanks:	0m ³
Total Capacity of Sludge Treatment Plant:	None
Capacity of Used Washwater System:	0 Mℓ/day
Primary Post Disinfection Type:	Sodium Hypochloride
Disinfection Dosing Capacity:	13 ℓ NaOCl/hr
Disinfectant Storage Capacity:	
Total Treated Water Storage Capacity:	0.5 Mℓ

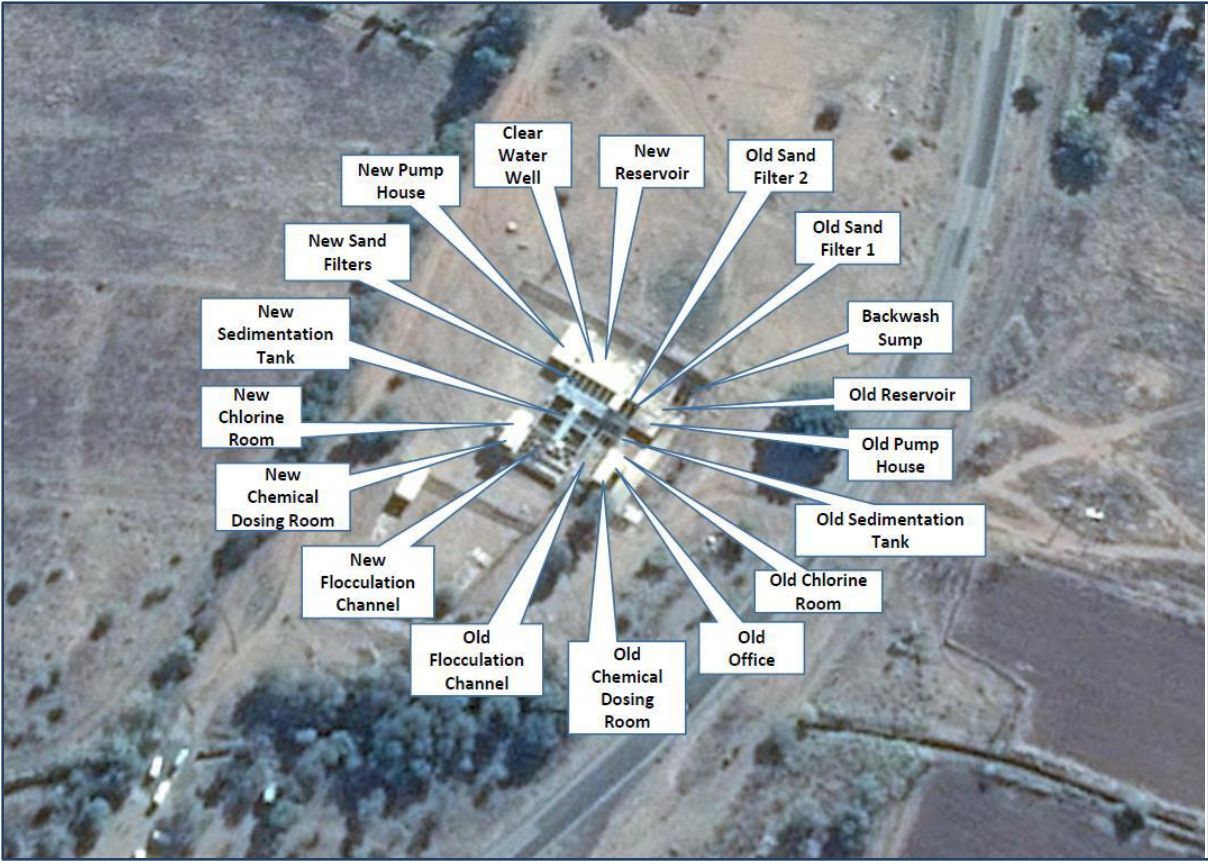

Figure 7.87 Aerial view of the Mudén WTP (Google Earth 2018).

Table 7.64 Pump details: Mudén Supply System.

System	Pump Station Name	Number of Pumps		Pump Description	Supply From	Supply To	Static Head (m)	Duty Head (m)	Duty Capacity (Ml/day)
		Number of Duty Pumps	Number of Standby Pumps						
Muden	PS 1	2	1	KSB WKLn 80/2	Muden WTP	Res 1	95	110	2.8
Muden	PS 2	1	1	KSB WKLn 40/6	Res 3	Res 4	124	144	0.5
Muden	PS 3	2	1	KSB NTC 65/50	Res 1	Res 2	216	250	1.7
Muden	PS 5	1	1	KSB WKLn 40/4	Res 5	Res 6	95	128	0.432
Muden	PS 7	1	1	KSB WKLn 65/10	Res 17	Res 16	51	115	0.5
Muden	PS 8	1	1	KSB WKLn 40/4	Res 6	Steel header tank	166	O/C*	O/C*

* PS 8 is out of commission as it cannot deliver the required head.

Table 7.65 Reservoir details: Mudén Supply System.

System	Reservoir Site	Reservoir Name	Capacity (Mℓ)	Function	TWL (aMSL)	FL (aMSL)
Mudén	Mudén	Res 3	0.350	Distribution	917	913
Mudén	Mudén	Res 4	0.100	Terminal	1041	1038
Mudén	Mudén	Res 5	0.250	Distribution	919	916
Mudén	Mudén	Res 6	0.250	Distribution	1014	1011
Mudén	Mudén	Res 7	0.250	Distribution	820	817
Mudén	Mudén	Res 8	0.450	Terminal	1104	1101
Mudén	Mudén	Res 1	0.250	Distribution	921	917
Mudén	Mudén	Res 2	0.450	Distribution	1136	1132
Mudén	Mudén	Res 9	0.300	Terminal	1257	1254
Mudén	Mudén	Res 12	0.150	Terminal	917	913
Mudén	Mudén	Res 13	0.150	Terminal	1135	1132
Mudén	Mudén	Res 14	0.150	Terminal	852	849
Mudén	Mudén	Res 18	0.100	Terminal	1246	1243
Mudén	Mudén	Res 16	0.100	Terminal	876	872
Mudén	Mudén	Res 17	0.150	Distribution	825	822

Table 7.66 Pipeline details: Muden Supply System.

System	Pipeline Name	From	To	Length (km)	Nominal Diameter (mm)	Material	Capacity (Ml/day)	Age (years)
Muden	Raw water pipeline	Irrigation canal	Muden WTP	0.3	315	uPVC	13.46*	4
Muden	Potable water pipeline	Muden WTP	Res 3	1.477	250	uPVC	6.36**	57#
Muden	Potable water pipeline	Res 3	Res 4	9.6	110	uPVC	1.23**	57#
Muden	Potable water pipeline	Muden PS	Res 1	4.37	250	uPVC	6.36**	57#
Muden	Potable water pipeline	Res 1	Res 2	3.05	160	uPVC	2.6**	57#
Muden	Potable water pipeline	Res 1	Res 8	3.936	160	uPVC	2.6**	57#
Muden	Potable water pipeline	Res 8	Res 9	2.7	160	uPVC	2.6**	57#
Muden	Potable water pipeline	Muden PS	Res 5	5.179	160	uPVC	2.6**	57#
Muden	Potable water pipeline	Muden PS	Res 7	8.2	160	uPVC	2.6**	57#
Muden	Potable water pipeline	Res 5	Res 6	2.215	110	uPVC	1.23**	57#
Muden	Potable water pipeline	Res 6	Steel Header Tank	4.99	110	uPVC	1.23**	57#
Muden	Potable water pipeline	Res 7	Res 17	3.29	110	uPVC	1.23**	57#
Muden	Potable water pipeline	Res 17	Res 16	6.55	110	uPVC	1.23**	57#

* Based on a velocity of 2 m/s ** Based on a velocity of 1.5 m/s # Age need to be verified

(b) Status Quo and Limitations of the Mudén Supply System

The primary water source for the regional scheme is the Mooi River. Abstraction from the Mooi River takes place at several locations, however, the ideal abstraction position is at an existing irrigation canal in Mudén. The canal's supply is from a weir constructed on the Mooi River, located approximately 7km from the existing Mudén WTP. The irrigation canal feeds water to the existing treatment plant via gravity and from there it is distributed to the Mudén and Opathe areas. The Craigieburn Dam, which is situated between Mooi River and Greytown augments the above mentioned weir as and when required through downstream releases.

The irrigation channel is fed from the Mooi River and supplies irrigation water to the farms in the area. The design capacity of the channel is sufficient to supply irrigation and domestic water for Mudén, Ophate and Keate's Drift. The channel is, however, an earthen channel and is prone to silting and damage. The channel is cleaned of silt and plant growth on a regular basis and this has increased the capacity of the channel significantly although further rehabilitation would be required to restore the channel to full design capacity. The supply is supported by the Craigieburn Dam which has sufficient capacity according to DWS. In March 2021, there has been a dispute relating to the raw water resource, between the farmers and uMzinyathi DM, which resulted in a total supply of only 1.567 Mℓ/day. The use of the canal as the primary raw water resource does pose a significant risk to the sustainability of supply and an alternative will have to be considered.

The current water sources at Keate's Drift and Ndaya schemes are inadequate and unsustainable to meet the water demand for the area. The community of Ndaya currently obtains water supplies from streams, rivers and springs in the area for domestic purposes. In most instances these rivers and streams are located more than two kilometres from households and water quality is considered poor.

An upgrade has been planned for the Mudén WTP to extend the supply to the Keate's Drift and Ndaya areas. The extension of the supply to these areas is currently in the design/construction stage.

The pump stations and pipe lines would have to deliver 5100 kℓ to Keate's Drift / Ndaya per day. The water would be delivered to a service reservoir from where it will be fed to the distribution networks and/or supply areas.

7.8 Recommendations for the uMzinyathi Water Treatment Plants

The projected total daily demand of 6.9 Mℓ/day, by 2025, for the Mudén BWSS (which includes the daily demand for Mudén and Opathe) was discussed with DWS, in order to establish whether the Craigieburn Dam would be a sustainable supplementary source and it was confirmed.

To meet current and future demand, the Mudén Bulk Water Supply Scheme has been planned and designed by Ilifa Consulting Engineers appointed by uMzinyathi DM and comprises of the following infrastructure:

- The expansion of the existing Mudén Water Treatment Plant from a capacity of 2.4 Mℓ/day to a capacity of 6.9 Mℓ/day.
- The relocation of the portable 1 Mℓ/day Water Treatment Plant, located near Keate's Drift abstraction works to Mudén to augment supply.

- The construction of approximately 150 km of bulk water pipelines ranging in diameter from 90 mm to 315 mm.
- The construction of several bulk water reservoirs totalling approximately 15 Mℓ of storage, and distribution reservoirs totalling 0.3 Mℓ of storage.
- The construction of six bulk water pump stations and two booster pump stations to carry water to the high lying areas of the project area.
- The construction of approximately 77 km of distribution water pipelines (including reticulation), ranging in diameter from 63 mm to 90 mm.
- The construction of approximately 410 standpipes to provide water to the entire project area.

In order to mitigate the constraints of the water supply to Keate's Drift, it is recommended to supply this area from Muden WTP and the preferred option is:

- A pump station at the plant pumping directly to the service reservoir over a distance of ± 17.3 km. The advantage of this option is that only one pump station at the plant is required. The disadvantage is that the pumping head is such that expensive pipes (ductile iron vs uPVC) or larger pipes (i.e. 400 mm v 315 mm) would be required. The total pumping head at the plant is ± 95 m requiring 75 kW motors for three pumps running in parallel.
- The centre line levels vary between 815 m at the purification plant and ± 700 m at the proposed service reservoir in Keate's Drift. The proposed Keate's Drift service reservoir top water level is slightly higher than the level at the plant. The water supply from the service reservoir to Keates Drift would require a pressure reducing installation. The supply scheme capacity up to the service reservoir is 90 ℓ/s and ± 150 ℓ/s downstream of the service reservoirs.

The aim of the Muden Bulk Water Supply Scheme is to:

- Consolidate water supply sources to achieve economies of scale.
- Provide a safe and reliable source of potable water to promote health and hygiene and reduce the incidence of waterborne diseases for a population of 59 880 (7485 households) in the project area.
- Create employment opportunities for the community for the duration of the construction programme.
- Promote community awareness in terms of general health and hygiene issues.

In summary, the project is recommended for the following reasons:

- It is a cost effective solution.
- It makes use of existing infrastructure most effectively.
- Operation and Maintenance activities at the Muden Abstraction Works and Water Treatment Plant are already in place, and therefore pose no new challenge to the operating authority.
- There is a guaranteed assurance of supply from the Muden irrigation canal which is supplied via the existing Craigieburn Dam.
- Eliminates the operation of multiple Water Treatment Works situated at various places within the Municipal boundaries i.e. economy of scale.

(uMzinyathi DM 2015)

7.8.1 Projects

(a) Mudén BWSS

Planning No.	
Project No.	
Project Status	Detailed design and construction

(i) Project Description

The current water sources at Keate's Drift and Ndaya schemes are inadequate and unsustainable to meet the water demand for the area. The community of Ndaya currently obtains water supplies from streams, rivers and springs in the area for domestic purposes. In most instances, these rivers and streams are located more than two kilometres from households and water quality is considered poor.

An upgrade has been planned for the Mudén WTP (**Figure 7.88**) to extend the supply to the Keate's Drift and Ndaya areas. The extension of the supply to these areas is currently in the Design/construction stage

Key information on this project is summarised in **Table 7.53**.

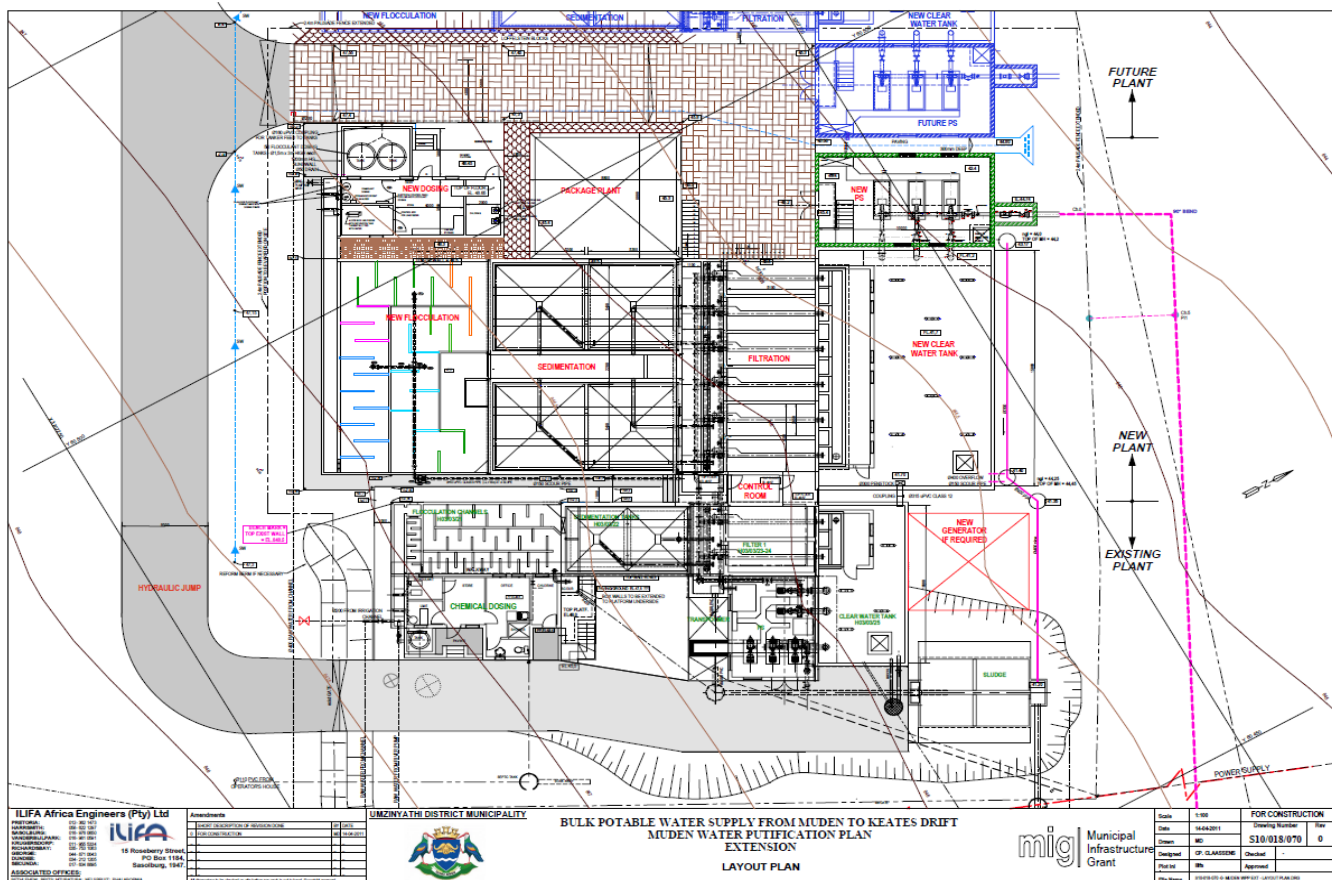

Figure 7.88 General layout of the Mudén WTP upgrade.

Table 7.67 Project information: Muden BWSS.

Project Components:	<ul style="list-style-type: none"> • The expansion of the existing Muden Water Treatment Plant from a capacity of 2.4 ML/day to a capacity of 6.9 Mℓ/day (Complete) • The relocation of the portable 1 ML/day Water Treatment Plant, located near Keates Drift abstraction works to Muden to augment supply. • The construction of approximately 150 km of bulk water pipelines ranging in diameter from 90mm to 315mm diameter pipelines (In construction). • The construction of several bulk water reservoirs totalling approximately 15ML of storage, and distribution reservoirs totalling 0.3ML of storage. • The construction of six bulk water pumpstations and two booster pumpstations to carry water to the high lying areas of the project area. • The construction of approximately 77km of distribution water pipelines (including reticulation), ranging in diameter from 63mm to 90mm. • The construction of approximately 410 standpipes which will provide water to the entire project area. •
Capacity:	6.9 Mℓ/day.

(ii) Beneficiaries

The upgrade to the BWSS will benefit consumers within the Muden, Opathe, Keate’s Drift and Ndaya areas with an estimated population of 59880.

(iii) Implementation

The construction duration of this project is anticipated to be six years. The total cost is estimated to be R142 million at 2020 prices.

REFERENCES

Department of Water Affairs and Forestry. 2004. *Thukela Water Management Area Internal Strategic Perspective (ISP)*. Pretoria: Department of Water Affairs and Forestry.

Department of Water and Sanitation. 2012. *Water Resources of South Africa*. Pretoria: Department of Water and Sanitation.

Department of Water and Sanitation, 2016. *Classification of significant water resources and determination of the comprehensive reserve and resource quality objectives in the Mvoti to Umzimkulu Water Management Area*. Pretoria: Department of Water and Sanitation.

Department of Water Affairs. 2011. *Water Reconciliation Project-Reutilisation of Treated Waste Water. PRELIMINARY PHASE-Rapid Determination of the Environmental Water Requirements for the uMngeni Estuary*. Pretoria: Department of Water Affairs.

Department of Water and Sanitation, 2015. *The uMkhomazi Water Project Phase 1: Module 1: Technical Feasibility Study Raw Water*. Pretoria: Department of Water and Sanitation.

Department of Water and Sanitation, 2017. *Reconciliation Strategy of the KwaZulu-Natal Coastal Metropolitan Area*. Pretoria: Department of Water and Sanitation.

Department of Water Affairs. 2010. *Water Reconciliation Strategy Study for the Kwazulu-Natal Coastal Metropolitan Areas; First Stage Strategy Infrastructure*. Pretoria: Department of Water Affairs.

ACKNOWLEDGEMENTS

uMngeni-uThukela Water's comprehensive 2023 Infrastructure Master Plan has been updated and improved to produce this 2024 version. The concerted effort of the Planning Services Department as a whole in producing this document is acknowledged and appreciated. Specific contributions by the various team members deserves acknowledgement:

- Alka Ramnath (Planner) Project management, Section 2, Spatial information, Research and input to all volumes
- Graham Metcalf (Geohydrologist) Groundwater and Wastewater
- Gavin Subramanian (Planning Engineer) Infrastructure on the North Coast System
- Angus Nicoll (Planning Engineer) Infrastructure on the South Coast and uMngeni Central Systems
- Vernon Perumal (Planning Engineer) Infrastructure on the uMkhomazi, Upper uMzintlava, Upper uMzimkhulu and the uMhlathuze and Middle uThukela Systems and compiling the Energy Section
- Mark Scott (Planning Engineer) Infrastructure on the uMngeni Inland, uMfolozi, uMkhuze, uPhongolo and Lake Sibiya Systems
- Nathaniel Padayachee (Planning Engineer) Infrastructure on the Upper uThukela and Buffalo Systems
- Ntuthuko Ngcamu (Head – Water Demand Management Unit) with support from Siphokazi Mabaso, Mathews Nokhanga and Dillon Jacks Water Demand Management Section
- Sakhile Hlalukane (Hydrologist) Water resources of the North Coast, South Coast and Upper uThukela Systems
- Sandile Sithole (Hydrologist) Water resources of all systems excluding the North Coast, South Coast and Upper uThukela Systems
- Mlungisi Shabalala (Hydrologist) Water resources of the Middle uThukela, uMhlathuze, uMfolozi, uMkhuze, uPhongolo and Lake Sibiya Systems
- Sithembile Mbonambi (Planning Analyst) Water resources of the uMkhomazi, Upper uMzintlava and Upper uMzimkhulu Systems

The 2024 Infrastructure Master Plan was not completed by the abovementioned people without the valued assistance of numerous other persons and parties. Their contributions are gratefully acknowledged. These include uMngeni-uThukela Water and WSA Operations Staff, uMngeni-uThukela Water's Water and Environment Department (water quality) and uMngeni-uThukela Water's Process Services Department (process and treatment details for UuW plants and others).

Kevin Meier,
MANAGER: PLANNING SERVICES